

NexGen[®] Legacy[®] Constrained Condylar Knee LCCK

For use with LCCK 4-in-1 Instrumentation

Surgical Technique



ZIMMER BIOMET
Your progress. Our promise.[®]

Table of Contents

Introduction	2
NexGen Revision Instrumentation Objectives	3
Establish the Tibial Platform	4
Re-establish the Tibial Platform	4
Finish the Tibia	8
Tibial Platform Decision Points	8
Offset Stem	8
Tibial Augmentation	9
Drill the Stem Base	10
Provisional Prosthesis	11
Revision Technique-Stabilize the Knee in Flexion	13
Prepare the Femoral Canal	13
Evaluate Femoral Size	14
Previous Prosthesis	14
Epicondylar Width	14
Prepare for Femoral Trialing	14
Establish Flexion Gap and Stability	16
Revision Technique-Stabilize the Knee in Extension	18
Establish Extension Gap and Stability	18
Balance Soft Tissues	19
Make Femoral Augment Cuts	19
Joint Line	20
Balance Flexion/Extension Gaps	20
Prepare for the LCCK Box	22
Make the LCCK Box Cut	25
Perform Trial Reduction	25
Primary Technique-Stabilize the Knee in Flexion	27
Prepare the Femoral Canal	27
Resect the Distal Femur	28
Evaluate Femoral Size	32
Epicondylar Width	32
Femoral Sizer	32
Verify Femoral Rotation and Positioning Using the 4-in-1 Instruments	34
Offset Stem Technique	36
Make the Anterior Cut	38
Make the Posterior Cut	39
Make the Chamfer Cut	40
Make the LCCK Box Cut	40
Drill the Femoral Stem Base	41
Perform Trial Reduction	42
Establish Flexion Gap and Stability	43

Primary Technique-Stabilize the Knee in Extension	45
Establish Extension Gap and Stability.....	45
Balance Soft Tissues.....	45
Balance Flexion/Extension Gaps	46
Prepare the Patella	48
Prepare the Patella	48
Patellar Tracking.....	49
Component Implantation	50
Tibial Component Preparation.....	50
Technique 1- “Back Table” Technique (Recommended)	51
Technique 2- Intraoperative Technique	53
Femoral Component Preparation	56
Stem Extension	56
Attachment of Augments	57
Appendix A-Augment Compatibility	60
Tibial Augment Compatibility	60
Femoral Augment Compatibility.....	62

Introduction

The NexGen Legacy Constrained Condylar Knee (LCCK) components are designed for use in both primary and revision surgeries (Figure 1).

The NexGen Revision Instruments are an intramedullary referencing system. All femoral and tibial cuts are based from reamers or stem extension provisionals located within the medullary canal.

The NexGen Revision Instruments allow the surgeon to convert from a NexGen primary implant to a stemmed LCCK implant intraoperatively. This crossover can be accomplished after the tibial preparation has been accomplished and the femoral cuts have been made via any of the NexGen primary techniques. If this is the case, proceed to “Prepare the Femoral Canal” on page 27 of this technique.

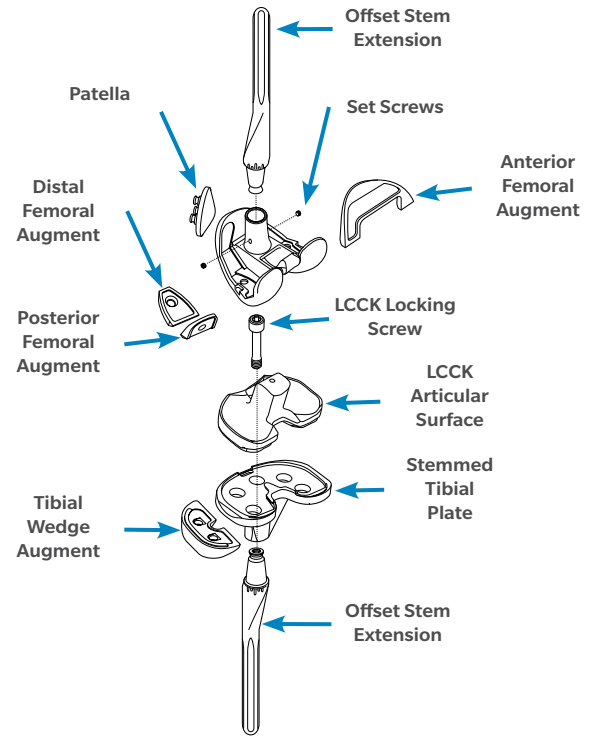

Figure 1

NexGen Revision Instrumentation Objectives

The four main objectives when using the NexGen Revision instruments are:

Re-Establish the Tibial Platform

The first goal is to establish a prosthetic platform on solid existing tibial bone stock. This will provide a reference plane for evaluating the flexion and extension gaps.

Stabilize the Knee in Flexion

Next, the femoral component size that will stabilize the knee in flexion is chosen and, if needed, augmentation to fit the femoral condylar bone stock is determined.

Stabilize the Knee in Extension

Next, the knee is stabilized in full extension to achieve collateral ligament symmetry and balance. Finally, flexion and extension gaps are balanced.

An acceptable position for the joint line is estimated to optimize patello-femoral tracking. This will aid in the determination of the proper articular surface thickness, distal femoral position (augments may be necessary), and femoral size that will stabilize the knee in extension.

Implantation

To further accommodate the specific needs of each patient, six tibial plate styles are compatible for use with the NexGen LCKK Femoral Component (Figure 2).

The part numbers listed are representative part numbers for shown procedures. See the NexGen Knee Profiler for a complete listing of part numbers.



Figure 2

Establish the Tibial Platform



Figure 3



Figure 4

Re-establish the Tibial Platform

The tibial platform is re-established first, as its articular surface is always part of the articulation, irrespective of the position of flexion or extension. By contrast, the distal femur comprises part of the articular surface only in extension, and the posterior femur only in flexion.

If necessary, create a starter hole by positioning the 8 mm IM step drill approximately 15 mm from the anterior cortex just over the midpoint of the isthmus of the tibial canal. In a primary case, this is just anterior to the insertion of the anterior cruciate ligament (Figure 3). Open up the medullary canal.

ⓘ **Technique Tip:** If the center of the tibia diaphysis and the center of the medullary canal do not coincide, an offset stem extension will be required.

ⓘ **Technique Tip:** Reamer diameters start at 9 mm and increase by 1 mm increments up to 24 mm.

ⓘ **Note:** A 9 mm reamer reams 9 mm in true diameter.

When initially reaming the canal, start with the 9 mm reamer and progressively ream until cortical contact is made. The cutting flutes should be buried without removing a significant amount of bone (Figure 4).

ⓘ **Warning:** There is relatively scant bone available in the tibia, and perforation or fracture can easily result from aggressive reaming.

Leave the reamer in place as it will serve as a stable aligned anchor for the tibial resection guide and the rest of the instrumentation necessary for the tibial preparation.

ⓘ **Technique Tip:** The largest reamer that can be completely buried for tibial preparation may be smaller than the reamer used to prepare for the final diameter and depth of the stem extension provisional and implant.

8 mm IM Step Drill
00-5978-014-00

NexGen Reamer
00-5125-010-09 See Profiler



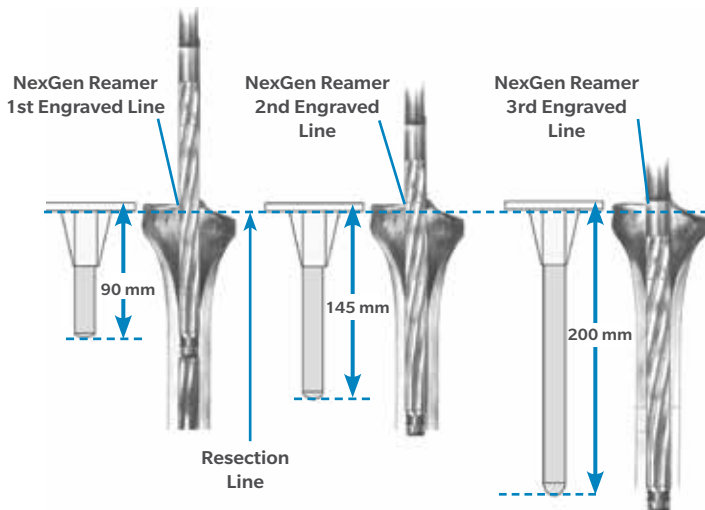

Figure 5



Figure 6

Re-establish the Tibial Platform (cont.)

Please review Figure 5 for reaming depths prior to final provisional trialing.

The 1st engraved line reams to the correct depth of 90 mm for a 75 mm NexGen Sharp Fluted Stem Extension.

The 2nd engraved line reams to the correct depth for a 145 mm NexGen Stem Extension.

The 3rd engraved line reams to the correct depth for the 200 mm NexGen Stem Extension.

Laying the desired tibial provisional assembly next to the reamer, and marking the depth to ream with a marking pen can also aid in reaming depth visualization.

☰ **Technique Tip:** Be sure that the reamer remains in line with the tibial shaft based on external tibial landmarks.

A method of checking the reamer alignment with the canal is to use a spacer block fitted with an extramedullary alignment rod (Figure 6).

☰ **Technique Tip:** If necessary, apply a tibial wedge augment provisional to defective bone to assure the reamer is correctly oriented.

NexGen Reamer
00-5125-010-09
See Profiler



Spacer Block|
00-5977-019-10
See Profiler



Alignment Rod
with Coupler
00-5785-080-00



Tibial Wedge Augment
Provisional
00-5989-003-20
See Profiler



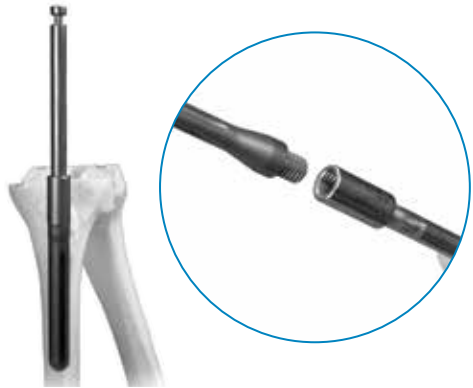

Figure 7



Figure 8



Figure 9

Re-establish the Tibial Platform (cont.)

Leave the final reamer in place, or remove the reamer and attach the straight stem extension provisional that corresponds to the last reamer size used to the stem provisional adapter.

Insert the stem extension provisional assembly into the reamed canal (Figure 7).

Slide the appropriate revision tibial boom (0°, 3°, or 7°) over the reamer or stem extension provisional assembly. Use the standard cut slot on any of the tibial cutting guides for a flat cut.

Slide the selected tibial cutting guide onto the appropriate tibial boom until it contacts the anterior tibia. Then tighten the thumb screw (Figure 8).

Attach the extramedullary alignment arch to the tibial boom and tighten the thumb screw. Then insert the alignment rod with coupler through the arch (Figure 9). Insure the resection surface will be 90° to the tibial mechanical axis, by palpating the malleoli and noting the midpoint.

ⓘ Technique Tip: The tibial cutting guide should be positioned so the alignment rod follows the anterior tibial crest and points about 7–10 mm medial to the midpoint between the malleoli, and is also in line with the tibial is anterior tendon.

After proper rotation and varus/valgus orientation has been achieved, determine the appropriate depth of resection.

Sizing Plate Handle
00-5977-096-00



Alignment Rod with Coupler
00-5785-080-00



Stem Provisional Adapter
00-5987-016-00



Revision Tibial Boom
00-5125-060-00, 0°
00-5977-005-00, 3°
00-5987-010-00, 7°



Tibial Wedge Cutter
00-5987-015-00
See Profiler



NexGen Reamer
00-5125-010-09
See Profiler



Straight Stem Extension Provisional
00-5989-010-10
See Profiler



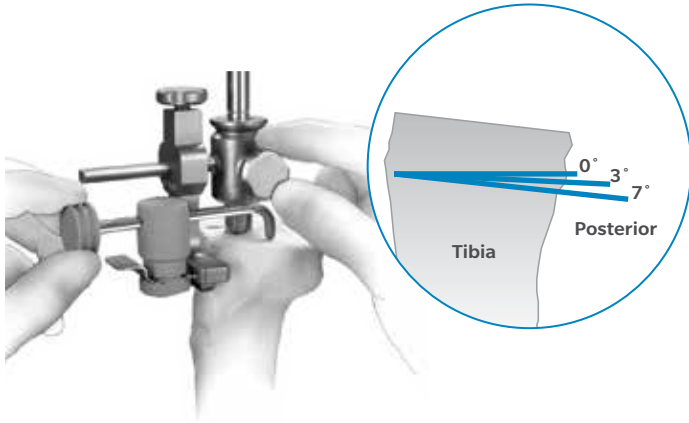

Figure 10



Figure 11

Re-establish the Tibial Platform (cont.)

ⓘ Technique Tip: In a revision case, minimal bone removal is recommended. The purpose of this cut is to create a flat surface only.

In a primary case, use the tibial depth resection gauge to define where the saw cut will be made. Insert the 10 mm tab of the gauge into the cutting slot (Figure 10). Readjust and tighten the thumb screw on the boom when the appropriate depth has been determined.

ⓘ Technique Tip: When the A/P wedge or 3° fluted tibial component has been chosen, the depth resection measurements should be taken as far back as possible. This will help re-establish the joint line since the posterior slope is built into the implant and not cut into the bone (Figure 10).

Fasten the appropriate tibial cutting guide (wedge or block) to the bone securely with two headless holding pins or two hex-headed screws. Use an oscillating saw with a 0.050 inch/1.27 mm blade to cut through the slots (Figure 11).

ⓘ Technique Tip: Hex-headed screws will provide a more stable tibial cutting guide during tibial resection.

Cut the medial and lateral tibia then remove the boom and reamer or stem extension provisional assembly. Finish the cut and remove the tibial cutting guide.













<p>NexGen Reamer 00-5125-010-09 See Profiler</p> 	<p>Straight Stem Extension Provisional 00-5989-010-10 See Profiler</p> 	<p>Stem Provisional Adapter 00-5987-016-00</p> 	<p>Revision Tibial Boom 00-5125-060-00, 0° 00-5977-005-00, 3° 00-5987-010-00, 7°</p> 	<p>Sizing Plate Handle 00-5977-096-00</p> 	<p>Tibial Sizing Plate 00-5977-012-03 See Profiler</p> 	<p>Alignment Rod with Coupler 00-5785-080-00</p> 	<p>Tibial Wedge Cutter 00-5987-015-00 See Profiler</p> 
<p>Headless Holding Pins 00-5222-039-00, 48 mm 00-5997-084-00, 75 mm</p> 	<p>MIS Screw Inserter/Extractor 00-5983-049-00</p> 	<p>Hex-headed Screws 00-5983-040-27, 27 mm 00-5983-040-33, 33 mm 00-5983-040-48, 48 mm</p> 	<p>Extramedullary Alignment Arch 00-5125-081-00</p> 	<p>Tibial Depth Resection Gauge 00-5987-040-00</p> 			



Figure 12



Figure 13



Figure 14

Finish the Tibia

Attach the appropriate sizing plate handle to the selected tibial sizing plate (Figure 12). The alignment rod is used through the slot in the sizing plate handle to aid in confirming varus/valgus alignment.

Reinsert the last reamer or stem extension provisional assembly used, parallel to the long axis of the bone.

Tibial Platform Decision Points

If the straight bushing allows for optimal sizing plate positioning, pin the plate with two short-head holding pins and proceed to “Drill the Stem Base” on page 10.

If the position is satisfactory, but tibial augmentation is necessary, proceed to the “Tibial Augmentation” procedure on page 9.

If the position of the sizing plate is not optimal, continue with the “Offset Stem” procedure.

Offset Stem

Remove the straight bushing, leaving the reamer or stem extension provisional assembly, and the sizing plate.

Slide the offset bushing over the reamer or stem provisional adapter until it seats into the circular step of the sizing plate.

When optimal coverage is achieved, note the position of the etched marks on the bushing relative to the etched mark on the center of the anterior portion of the sizing plate (see arrow Figure 14).

ⓘ Technique Tip: Pins should not be used on the side of the tibia requiring augmentation. Proceed to “Tibial Augmentation” on page 9.

Pin the sizing plate with two short-head holding pins.

NexGen Reamer
00-5125-010-09
See Profiler

Straight Stem Extension Provisional
00-5989-010-10
See Profiler

Stem Provisional Adapter
00-5987-016-00

Tibial Sizing Plate
00-5977-012-03
See Profiler

Straight Bushing
00-5987-003-00

Short-head Holding Pin
00-5977-056-01

Offset Bushing
00-5987-004-00





Figure 15

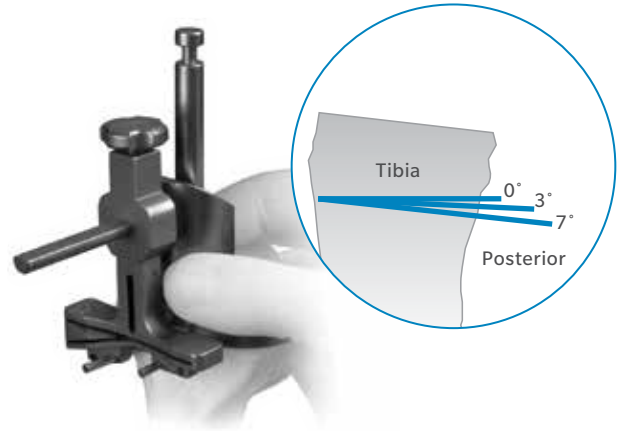

Figure 16

Offset Stem (cont.)

ⓘ Technique Tip: The sizing plate must be removed prior to the reamer or stem extension provisional assembly if their diameter exceeds 19 mm.

Remove the bushing and the reamer or stem extension provisional assembly leaving only the sizing plate, and proceed to “Drill the Stem Base” on page 10.

Tibial Augmentation

Slide the appropriate offset revision tibial boom (0°, 3°, or 7°) over the reamer or stem provisional adapter, and the straight or offset bushing (Figure 15).

ⓘ Note: Tibial augments are not interchangeable. Use stemmed augments with stemmed tibial plates, and fluted augments with fluted tibial plates.

Tighten the thumb screw on the boom and attach the appropriate tibial cutting guide. Tighten the thumb screw (Figure 16).

Fasten the appropriate tibial cutting guide (wedge or block) to the bone securely with two headless holding pins or two hex-headed screws.

Use an oscillating saw with a 0.050 inch/1.27 mm blade to begin the augmentation cut. Remove the boom, reamer or stem extension provisional assembly, bushing, and sizing plate. Finish the cut and remove the tibial cutting guide.

Attach the appropriate tibial augment provisionals to the sizing plate and pin the plate to the bone with two short-head holding pins.

ⓘ Note: Augment options can be found within Appendix A – Augment Compatibility.

ⓘ Technique Tip: One of the pins can be inserted through the tibial augment provisionals.













NexGen Reamer 00-5125-010-09 See Profiler 	Straight Stem Extension Provisional 00-5989-010-10 See Profiler 	Stem Provisional Adapter 00-5987-016-00 	Tibial Sizing Plate 00-5977-012-03 See Profiler 	Straight Bushing 00-5987-003-00 	Offset Bushing 00-5987-004-00 	Short-head Holding Pin 00-5977-056-01 	Offset Revision Tibial Boom 00-5987-018-00, 0° 00-5977-013-00, 3° 00-5987-017-01, 7° 
Tibial Wedge Cutter 00-5987-015-00 See Profiler 	Headless Holding Pins 00-5222-039-00, 48 mm 00-5997-084-00, 75 mm 	MIS Screw Inserter/ Extractor 00-5983-049-00 	Hex-headed Screws 00-5983-040-27, 27 mm 00-5983-040-33, 33 mm 00-5983-040-48, 48 mm 				



Figure 17

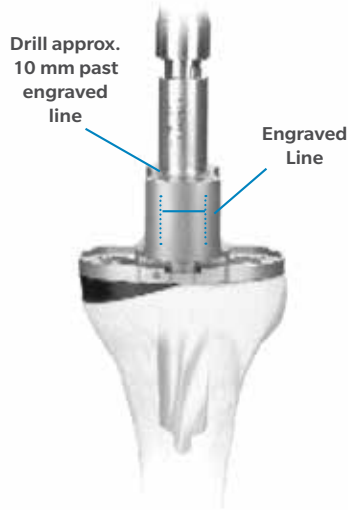

Figure 18A



Figure 18B

Drill the Stem Base

Place the appropriate tibial drill guide (stemmed or fluted) onto the sizing plate (Figure 17) and drill for the tibial stem base with the corresponding stem drill.

Drill approximately 10 mm deeper than the engraved line on the drill (Figure 18A). This step ensures adequate clearance for the transition length of the proximal and distal diameters of the stem extension.

If using a 12.7 mm x 30 mm stem extension, place the porous stem tibial drill guide on the sizing plate and drill for the stem with the porous stem tibia drill. Drill until the top of the drill is flush with the top of the drill guide (Figure 18B).

Failure to attain the correct drill depth may cause slight interference fit during implantation. Remove the drill and drill guide. If the tibia has already been reamed to a 17 mm diameter or greater, this drilling step is not required.

Tibial Wedge
Augment Provisional
 00-5989-003-20
 See Profiler



Short-head
Holding Pin
 00-5977-056-01



Tibial Drill Guide
 00-5977-014-00
 Stemmed
 00-5977-014-02
 Fluted



Tibial Stem Drill
 00-5977-010-00
 Stemmed Cemented
 00-5977-010-01 Stemmed
 00-5977-010-02 Fluted





Figure 19



Figure 20

Provisional Prosthesis

Attach the proper size and style tibial broach to the broach impactor (Figure 19).

Seat the impactor over the location pegs on the sizing plate, and impact the broach (see arrow Figure 20). The broach has a built-in stop to prevent over impaction.

Remove the broach impactor assembly and sizing plate.

Assemble the appropriate tibial provisional, stem extension provisional, and tibial augment provisional, if needed, for which the bone has been prepared. Use the 3.5 mm hex-head screwdriver to secure the stem extension provisional in place.

Tibial Wedge Augment Provisional 00-5989-003-20 See Profiler	Tibial Sizing Plate 00-5977-012-03 See Profiler	Short-head Holding Pin 00-5977-056-01	Tibial Drill Guide 00-5977-014-00 Stemmed 00-5977-014-02 Fluted	Tibial Stem Drill 00-5977-010-00 Stemmed Cemented 00-5977-010-01 Stemmed 00-5977-010-02 Fluted	Tibial Broach 00-5977-013-03 See Profiler	Tibial Broach Impactor 00-5977-011-00	Mallet 00-0155-002-00
							

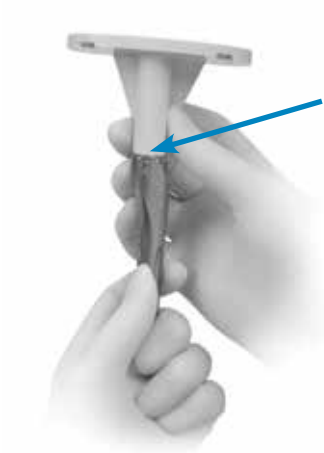

Figure 21



Figure 22

Trial Prosthesis (cont.)

For an offset stem, line up the appropriate mark on the offset stem extension provisional with the etch mark on the tibial provisional (see arrow Figure 21). This mark should correspond to the mark noted earlier on the offset bushing.

ⓘ **Technique Tip:** If using an offset stem provisional, do not fully tighten the stem extension. This will allow the tibial provisional to rotate to an optimal position.

Insert the final tibial provisional assembly into the tibia.

Impact the tibial provisional with the tibial provisional impactor (Figure 22).

ⓘ **Technique Tip:** The A/P wedge sizing plate can be used as a tibial provisional by attaching the stem base adaptor (00-5987-006-00) to the appropriate sizing plate and attaching the appropriate stem extension to the stem base adaptor.

If final reaming has not been completed, refer to back page 4 (Figure 4).

Use the 3.5 mm Hex-head Screwdriver to secure the Stem Extension Provisional in place.

ⓘ **Technique Tip:** Upon removal of the tibial provisional assembly, note the etch mark location on the stem extension provisional relative to the tibial provisional alignment mark (see arrow Figure 21). This will be used as the alignment of the offset stem extension implant.

ⓘ **Technique Tip:** Leaving the tibial provisional assembly in place for the remainder of the procedure will protect the freshly resected tibial bone.

Tibial Provisional
00-5981-037-01
See Profiler



Straight Stem Extension Provisional
00-5989-010-10
See Profiler



Offset Stem Extension Provisional
00-5987-020-11
See Profiler



Tibial Wedge Augment Provisional
00-5989-003-20
See Profiler



3.5 mm Hex-head Screwdriver
00-5987-089-00



Tibial Provisional Impactor
00-5977-009-00



Mallet
00-0155-002-00



Revision Technique – Stabilize the Knee in Flexion



Figure 23

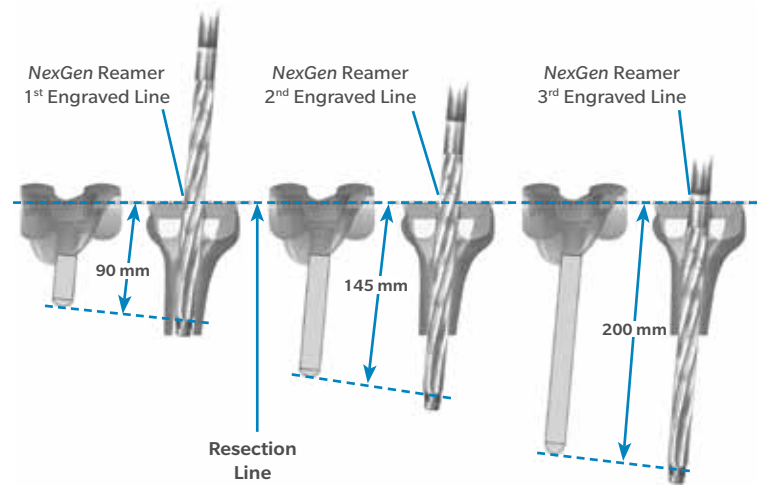

Figure 24

Prepare the Femoral Canal

If necessary, use the 8 mm IM step drill to make a starter hole (Figure 23).

When initially reaming the canal, start with the 9 mm reamer and progressively ream until cortical contact is made at the desired depth and reamer diameter. (Figures 23 and 24).

☰ **Technique Tip:** Reamer diameters start at 9 mm and increase by 1 mm increments up to 24 mm.

☰ **Note:** A 9 mm reamer reams 9 mm in true diameter.

Please review Figure 24 for reaming depths prior to final provisional trialing.

- The 1st engraved line reams to the correct depth of 90 mm for a 75 mm NexGen Sharp Fluted Stem Extension.
 - The 2nd engraved line reams to the correct depth for a 145 mm NexGen Stem Extension.
 - The 3rd engraved line reams to the correct depth for the 200 mm NexGen Stem Extension.
 - Laying the desired femoral provisional assembly next to the reamer, then marking the depth to ream with a marking pen can also aid in reaming depth visualization.
- ☰ **Technique Tip:** Note the diameter and depth reamed of the last reamer used once final reaming is complete.

8 mm IM Step Drill
00-5978-014-00



NexGen Reamer
00-5125-010-09
See Profiler



Tibial Provisional
00-5981-037-01
See Profiler



Femoral Provisional/Cutting Guide
00-5995-013-91, Lt
00-5995-013-92, Rt
See Profiler



Straight Stem Extension
Provisional
00-5989-010-10
See Profiler

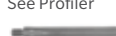



Transepicondylar Width (mm)	Female Size	Male Size
75	C	-
80	D	C
85	E	D
90	F	E
95	G	F
100	-	G

Figure 25



Figure 26

Evaluate Femoral Size

Previous Prosthesis

Measure the size of the revised previous prosthesis.

- ⓘ **Caution:** When using the previous prosthesis to determine size, note the primary TKA failure may have been caused by the component being over or undersized.

Epicondylar Width

The epicondylar width of the femur also aids in selecting the appropriate femoral size. Measure the width of the epicondyles and use the following chart to assist in defining the appropriate size (Figure 25). By measuring the epicondyles, the maximum size has been determined.

- ⓘ **Technique Tip:** Evaluation of the preoperative x-ray of the patient’s other knee may help in making the final sizing decision.

Prepare for Femoral Trialing

Insert the appropriate size straight stem extension provisional into the appropriate size LCKK femoral provisional/cutting guide (Figure 26).

- ⓘ **Technique Tip:** If the straight stem extension provisional does not provide adequate coverage, use an offset stem extension provisional.

Straight Stem Extension Provisional
00-5989-010-10
See Profiler



Femoral Provisional/Cutting Guide
00-5995-013-91, Lt
00-5995-013-92, Rt
See Profiler



Offset Stem Extension Provisional
00-5989-020-11
See Profiler





Figure 27

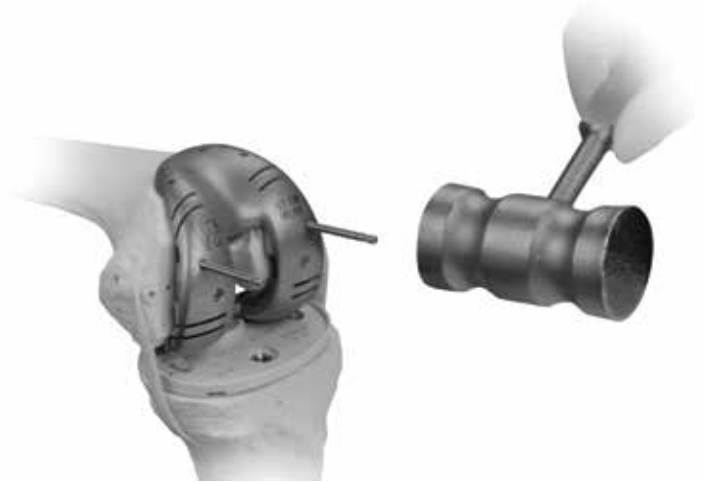

Figure 28

Prepare for Femoral Trialing (cont.)

ⓘ Technique Tip: If you can't insert the femoral provisional, or if the rotation is incorrect, proceed to page 22 and make the femoral bone cuts.

With the knee in flexion, insert the femoral provisional/cutting guide assembly onto the distal femur. Seat the femoral provisional assembly on the existing bone. If the components will not seat, use a rongeur to carefully remove any anterior or posterior bone that is preventing insertion.

ⓘ Caution: Be careful not to over resect.

Insert the tabs of the revision rotational alignment guide into the posterior augment resection slots of the femoral provisional (Figure 27).

The handles of the alignment guide should line up with the transepicondylar axis.

Insert the headless holding pins to set femoral rotation (Figure 28).

These pins can be used later to position the LCKK 4-in-1 femoral cut block.

Straight Stem Extension Provisional
00-5989-010-10
See Profiler



Offset Stem Extension Provisional
00-5989-020-11
See Profiler



Femoral Provisional/Cutting Guide
00-5995-013-91, Lt
00-5995-013-92, Rt
See Profiler



Tibial Provisional
00-5981-037-01
See Profiler



Rotational Alignment Guide
00-5987-051-01



Headless Holding Pins
00-5222-039-00, 48 mm
00-5997-084-00, 75 mm



Mallet
00-0155-002-00





Figure 29

Establish Flexion Gap and Stability

Begin by inserting the thinnest LPS articular surface provisional of the color indicated on the tibial provisional and femoral provisional.

ⓘ Technique Tip: The LCCK articular surface provisionals cannot be used because the intercondylar box cut has not yet been made.

Evaluate the stability in flexion (Figure 29).

If the thinnest articular surface cannot be inserted consider the following:

- Downsize the femoral component
- Lower the tibial plateau/joint line

If the thinnest articular surface does not tense the flexion gap adequately, insert progressively thicker articular surface provisionals until adequate stability is obtained.

If the thickest articular surface does not tense the flexion gap consider the following:

- Augment the tibial provisional with a 5 mm or 10 mm block on both the medial and lateral sides
- Select the next larger femoral provisional/cutting guide

The color key for matching components within the LCCK system which follows should be used.

LPS Articular Surface Provisional
00-5996-030-10
See Profiler



Distal Femoral Augment Provisional
00-5987-090-05
See Profiler



Posterior Femoral Augment Provisional
00-5987-089-05
See Profiler



NexGen Complete Knee Solution
Component Matching Flowchart

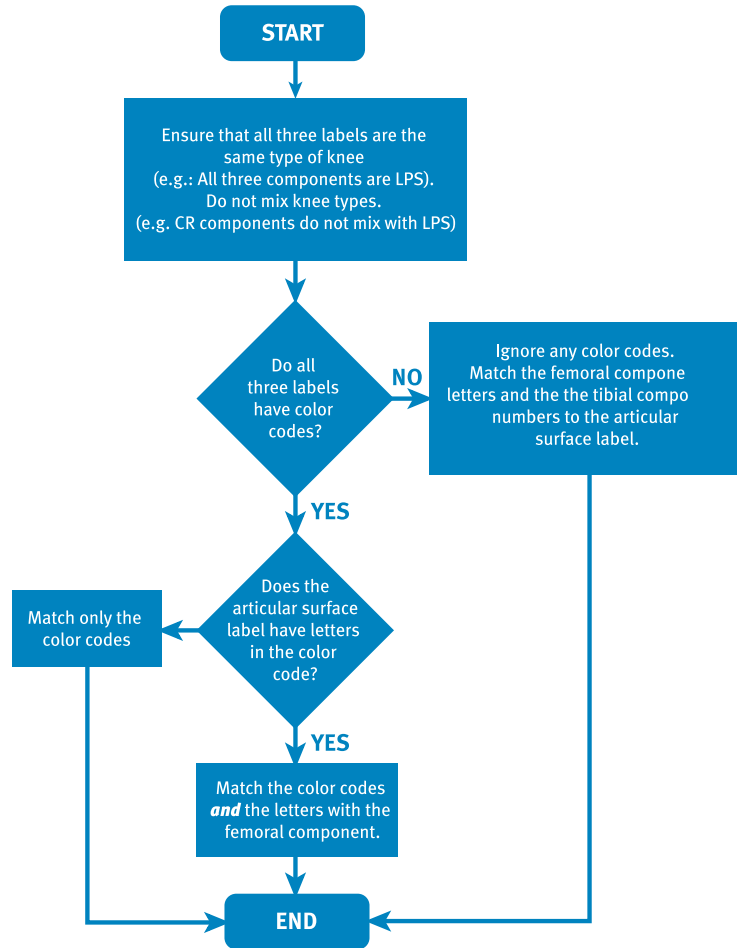

NexGen Legacy Knee Constrained Condylar LCKK

		Femoral Size					
		C	D	E	F	G	
Tibial Size	1-2	SP CD/1-2	SP CD/1-2	E/1-2*			
	3-4	Y CD/3-4	Y CD/3-4	SY EF/3-4	SY EF/3-4	G/3-4*	
	5-6	SG CD/5-6	SG CD/5-6	G EF/5-6	G EF/5-6	SG G/5-6	
	7-10			SB EF/7-10	SB EF/7-10	B G/7-10	
Patella Size		Use Standard Size Patellas with all LCKK Femoral Components					
		26 mm (inset only)†	32 mm†	38 mm	29 mm†	35 mm	41 mm

Color Key

- P = Purple
- Y = Yellow
- G = Green
- B = Blue
- SP = Striped Purple
- SP = Striped Blue
- SY = Striped Yellow
- SG = Striped Green

† For G Femoral Components, the 26, 29 and 32 mm patellar components must be inset.

*LPS-Flex Prolong® Polyethylene Articular Surface Only

Revision Technique - Stabilize the Knee in Extension



Figure 30



Figure 31

Establish Extension Gap and Stability

After achieving the appropriate stability in flexion, leave the final LPS articular surface provisional in place and bring the knee to full extension. A symmetrical and balanced extension gap should be created.

As the revision knee arthroplasty is extended, assess the full extension, the desired valgus alignment, and adequate varus/valgus stability (Figure 30).

ⓘ Technique Tip: The distal femoral augment provisionals may be used as spacers to create added stability in extension (Figure 31).

If the gap exceeds the maximum augment available, 20 mm, then evaluate the next smaller femoral provisional size. This will allow the use of a thicker articular surface provisional and will necessitate a reassessment of the flexion gap.

Straight Stem Extension Provisional
00-5989-010-10
See Profiler



LPS Articular Surface Provisional
00-5996-030-10
See Profiler



Distal Femoral Augment Provisional
00-5987-090-05
See Profiler



Posterior Femoral Augment Provisional
00-5987-089-05
See Profiler



Tibial Provisional
00-5981-037-01
See Profiler



Femoral Provisional/Cutting Guide
00-5995-013-91,Lt
00-5995-013-92,Rt
See Profiler





Figure 32



Figure 33

Balance Soft Tissues

Unless large deformities are due exclusively to bone loss and the subsidence of the components, conventional soft tissue releases will be necessary.

With the knee in extension, perform the necessary ligament releases to achieve symmetric and adequate tension in a manner similar to that in a primary arthroplasty.

Make Femoral Augment Cuts

Insert a retractor to protect the posterior capsule, and tibial bone or provisional.

Make any necessary posterior or distal femoral augment cuts through the femoral provisional/cutting guide using a 0.050 inch/1.27 mm thick reciprocating saw blade (Figures 32 and 33).

- ⓘ **Note:** Augment options can be found within Appendix A – Augment Compatibility.
- ⓘ **Technique Tip:** It may be necessary to remove the femoral provisional/cutting guide to complete any distal femoral augment cuts.

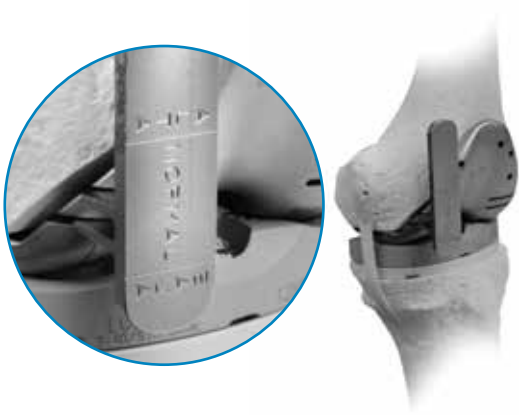

Figure 34

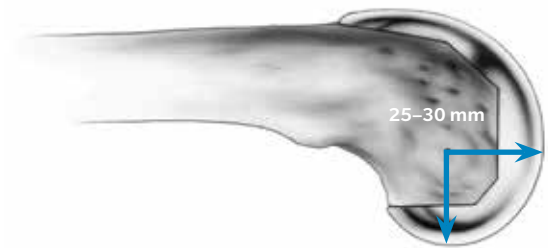

Figure 35

Joint Line

If desired, use the patella joint line gauge to assess the position of the patella.

With the tabs of the gauge positioned in the two slots on the anterior flange of the femoral provisional/cutting guide, the inferior pole of the patellar provisional or unresurfaced patella should fall between the two “Normal” marks on the gauge (Figure 34).

The epicondyles also provide a reference point for distal positioning of the femoral component. The distal joint line averages 25 mm from the lateral epicondyle and 30 mm from the medial epicondyle. This is very similar to the average distance to the posterior joint line and this distance may be used to check femoral component size (Figure 35).

Balancing Flexion/Extension Gaps

It is important to remember that adjustments to the femoral side of the arthroplasty can affect the knee in either flexion or extension, while any change to the tibia affects both flexion and extension. This is part of the rationale for reconstructing the tibial side of the joint first. The following matrix (Figure 36) suggests the nine situations that can occur during a trial reduction in a revision knee.

Straight Stem Extension Provisional
00-5989-010-10
See Profiler



LPS Articular Surface Provisional
00-5996-030-10
See Profiler



Femoral Provisional/Cutting Guide
00-5995-013-91,Lt
00-5995-013-92,Rt
See Profiler



Tibial Provisional
00-5981-037-01
See Profiler



Patella Joint Line Gauge
00-5987-099-00



		Extension		
		Tight	OK	Loose
Flexion	Tight	1	2	3
	OK	4	5	6
	Loose	7	8	9

Figure 36

⊖ Technique Tip: Perform a trial reduction after implementing any of these solutions. This will verify the solution or identify any new problems and/or a variation of the initial problem that may still exist.

1. Two options exist

- Use a thinner articular surface.
- Resect more tibia.

2. Three options exist

- Use an offset stem extension to move the femoral component anteriorly.
- Use a smaller femoral component.
- Use a distal femoral augment to move the femoral component distally and use a thinner articular surface.

3. Three options exist

- Use a distal femoral augment to lower the joint line and allow use of a thinner articular surface.
- Use a thicker articular surface and use a smaller femoral component.
- Use an offset stem extension to move the femoral component anteriorly and use a thicker articular surface.

4. Two options exist

- Release the posterior capsule from the femur.
- Resect additional distal femoral bone and move the femoral component proximally.

5. No further modification is necessary

6. Two options exist

- Use a distal femoral augment with the same articular surface. This drops the joint line and tightens the extension gap.
- Downsize the femoral component and use a thicker articular surface. This will probably raise the joint line.

7. Three options exist

- Resect additional distal femoral bone and use a larger femoral component with posterior femoral augments.
- Resect additional femoral bone and use a thicker articular surface with a more proximal femoral position.
- Resect additional distal femoral bone and use an offset stem extension to move the femoral component posteriorly. Use posterior femoral augments.

8. Four options exist

- Use a larger femoral component with posterior femoral augments. This may equalize gaps.
- Resect additional distal femoral bone and use a thicker articular surface with a more proximal femoral position.
- Use an offset stem extension to move the femoral component posteriorly. Use posterior femoral augments.
- Choose to accept the current balance if it is only of a mild degree, particularly in a highly constrained component.

9. Use a thicker Articular Surface

Always consider the position of the patella and joint line in the final soft tissue balancing.

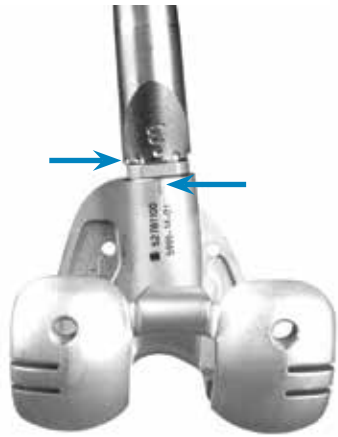

Figure 37



Figure 38



Figure 39

Prepare for the LCCK Box

Remove the femoral provisional/cutting guide assembly from the bone.

If an offset stem was used, note the stem location number relative to the etched line on the posterior stem base housing (Figure 37).

Remove the stem extension provisional from the femoral provisional cutting guide and insert it into the stem extension bushing (Figure 38).

Reinsert one or two of the headless holding pins (Figure 39). These pins will serve to provide rotational alignment for the LCCK notch cut guide/4-in-1 femoral cut block assembly.

ⓘ Technique Tip: One headless pin will also provide sufficient rotational alignment along with the central stem base and stem extension provisional.

When using an offset stem extension, fully thread the offset stem locknut onto the appropriate size offset stem extension provisional.

Thread the offset stem extension provisional onto the stem extension bushing and rotate it so the appropriate number is lined up to the position noted earlier on the femoral provisional cutting/guide (Figure 37).

Then back thread the locknut against the stem extension bushing and use the offset stem wrench to tighten the locknut against the stem extension bushing.

**Femoral Provisional/
Cutting Guide**
00-5995-013-91,Lt
00-5995-013-92,Rt
See Profiler



**Straight Stem
Extension
Provisional**
00-5989-010-10
See Profiler



**LCCK Stem
Extension Bushing**
00-5987-070-00



Headless Holding Pins
00-5222-039-00, 48 mm
00-5997-084-00, 75 mm



Mallet
00-0155-002-00



**Offset Stem Extension
Provisional**
00-5989-020-11
See Profiler



**Offset Stem
Locknut**
00-5987-080-00



**Offset Stem
Wrench**
00-5987-079-00





Figure 40



Figure 41



Figure 42

Prepare for the LCKK Box (cont.)

If the distal femoral augment provisionals were used on the femoral provisional/cutting guide, remove and install them on the LCKK 4-in-1 femoral cut block. These provisionals should correspond to the augment cuts that were made on page 19 (Figures 32 and 33) of this technique.

ⓘ Technique Tip: When removing the femoral augment provisionals from any instrument, use the 3.5 mm hex-head screwdriver to push the peg of the augment from the opposite side (Figure 40).

Insert the appropriate size LCKK notch cut guide until it is fully seated in the LCKK 4-in-1 femoral cut block.

Insert the stem extension bushing assembly into the LCKK notch cut guide/4-in-1 femoral cut block assembly.

Ensure that the proper “R” or “L” engraving is showing anteriorly for a right or left knee respectively.

Insert the entire LCKK notch cut guide/4-in-1 femoral cut block assembly into the femoral canal over the headless pins (Figures 41 and 42). Be sure that the pins protrude beyond the face of the LCKK 4-in-1 femoral cut block so they can be grasped with a pin puller for extraction.

ⓘ Technique Tip: The A/P position of the LCKK notch cut guide/4-in-1 femoral cut block assembly is determined by the orientation of the medullary canal. Therefore, the anterior flange of the guide is not designed to sit flush with the cut surface of the anterior femoral bone.

**Femoral Provisional/
Cutting Guide**
00-5995-013-91,Lt
00-5995-013-92,Rt
See Profiler



**LCKK 4-in-1 Femoral
Cut Block**
00-5987-021-03
See Profiler



**Distal Femoral
Augment Provisional**
00-5987-090-05
See Profiler



**LCKK Notch Cut
Guide**
00-5987-022-01
See Profiler



**Straight Stem Extension
Provisional**
00-5989-010-10
See Profiler



Headless Holding Pins
00-5222-039-00, 48 mm
00-5997-084-00, 75 mm



**LCKK Stem
Extension
Bushing**
00-5987-070-00



**3.5 mm Hex-head
Screwdriver**
00-5987-089-00



Tibial Provisional
00-5981-037-01
See Profiler





Figure 43

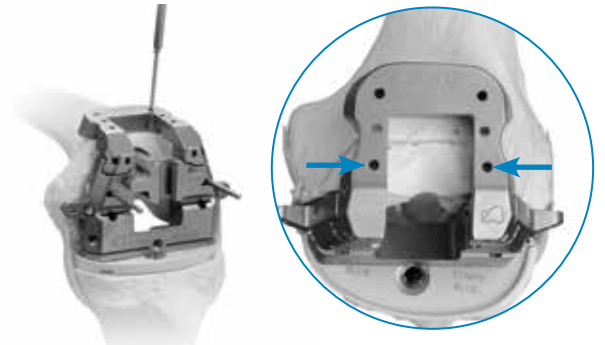

Figure 44

Prepare for the LCCK Box (cont.)

- ⓘ Technique Tip:** The 15 mm and 20 mm distal femoral augment provisionals will block access through the screw fixation holes in the 4-in-1 femoral cut block.
- ⓘ Technique Tip:** The inside screw holes should be used for all revision cases that do not require distal femoral augments. The outside screw holes should be used with 5 mm or 10 mm distal femoral augment provisionals.
- ⓘ Technique Tip:** The first set of holes on the notch cut guide should not be used if any augmentation is used on the 4-in-1 femoral cut block (see arrows Figure 44).

Use two hex-headed screws to secure the 4-in-1 femoral cut block to the distal femoral bone (Figure 43).

Use two 33 mm hex-headed screws through the top of the notch cut guide (Figure 44).

Once the LCCK notch cut guide/4-in-1 femoral cut block assembly is secured, remove the stem extension bushing and the stem extension provisional by pulling the assembly out of the 4-in-1 femoral cut block. The femoral extractor may be used.

<p>Distal Femoral Augment Provisional 00-5987-090-05 See Profiler</p> 	<p>MIS Screw Inserter/Extractor 00-5983-049-00</p> 	<p>Hex-headed Screws 00-5983-040-27, 27 mm 00-5983-040-33, 33 mm 00-5983-040-48, 48 mm</p> 	<p>LCCK 4-in-1 Femoral Cut Block 00-5987-021-03</p> 	<p>LCCK Notch Cut Guide 00-5987-022-01 See Profiler</p> 	<p>Tibial Provisional 00-5981-037-01 See Profiler</p> 
<p>Straight Stem Extension Provisional 00-5989-010-10 See Profiler</p> 	<p>LCCK Stem Extension Bushing 00-5987-070-00</p> 	<p>Femoral Extractor 00-5785-097-00</p> 			

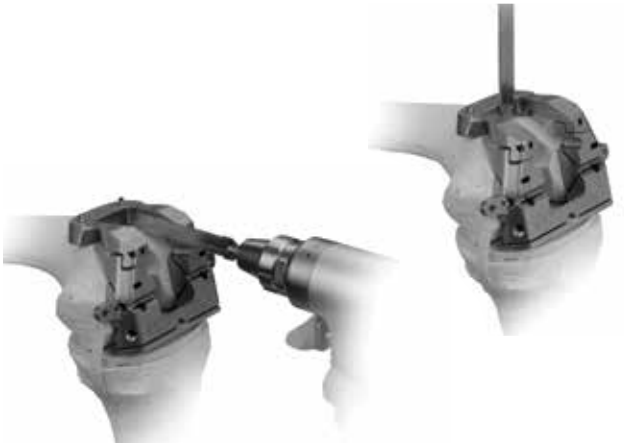

Figure 45



Figure 46

Make the LCKK Box Cut

Use the reciprocating saw to cut the sides and base of the LCKK box (Figure 45).

Remove the LCKK notch cut guide/4-in-1 femoral cut block assembly.

Perform Trial Reduction

Slide the appropriate size modular box provisional onto the femoral provisional/cutting guide (Figure 46).

Attach the appropriate posterior femoral augment provisionals, then the distal femoral augment provisionals (Figure 46).

If distal femoral augmentation is not necessary, use a femoral augment provisional screw to secure the provisional box (Figure 46).

ⓘ Technique Tip: The modular box provisional is angled to match the bone cut. The provisional box does not match the femoral implant.











Modular Box Provisional 00-5995-013-00 See Profiler	Femoral Provisional/Cutting Guide 00-5995-013-91, Lt 00-5995-013-92, Rt See Profiler	Posterior Femoral Augment Provisional 00-5987-089-05 See Profiler	Distal Femoral Augment Provisional 00-5987-090-05 See Profiler	Femoral Augment Provisional Screw 00-5987-085-00	3.5mm Hex-head Screwdriver 00-5987-089-00
					
Anterior Femoral Augment Provisional 00-5989-033-31 See Profiler	Offset Stem Extension Provisional 00-5989-020-11 See Profiler	Offset Stem Locknut 00-5987-080-00	Straight Stem Extension Provisional 00-5989-010-10 See Profiler		
					



Figure 47



Figure 48

Perform Trial Reduction (cont.)

If necessary, use the appropriate anterior femoral augment provisional.

Assemble the stem extension provisional to the femoral provisional/cutting guide (Figure 47).

ⓘ Technique Tip: If it was determined an offset stem extension would be needed, insert the appropriate diameter and set it to the orientation noted on page 22 (Figure 37).









Insert the femoral provisional/cutting guide assembly onto the bone to check for proper fit.

Insert the correct size and style tibial provisional with the selected tibial augment provisional, if needed, and stem extension provisional.

Attach the proper height and style of articular surface provisional onto the tibial provisional.

When implanting an LCCK femoral component, insert the LPS articular surface provisional. If more constraint is needed, remove the LPS provisional and insert the LCCK articular surface provisional. For either the LPS or LCCK articular surface provisional, insert the locking screw through the articular surface and tighten with the 3.5 mm hex-head screw-driver, if desired (Figure 48).

To assess patellar tracking, proceed to “Prepare the Patella” on page 48.

Femoral Provisional/ Cutting Guide 00-5995-013-91, Lt 00-5995-013-92, Rt See Profiler	LPS Articular Surface Provisional 00-5961-030-10 See Profiler	LCCK Articular Surface Provisional 00-5995-022-10 See Profiler	Tibial Provisional 00-5981-037-01 See Profiler	Straight Stem Extension Provisional 00-5989-010-10 See Profiler	Articular Surface Provisional Locking Screw 00-5995-075-00	3.5 mm Hex- head Screwdriver 00-5987-089-00
						
Offset Stem Extension Provisional 00-5989-020-11 See Profiler	Offset Stem Locknut 00-5987-080-00					
						

Primary Technique – Stabilize the Knee in Flexion



Figure 49

Prepare the Femoral Canal

If necessary, use the 8 mm IM step drill to make a starter hole (Figure 49).

When initially reaming the canal, start with the 9 mm reamer and progressively ream until cortical contact is made. The cutting flutes should be completely buried (Figure 49).

☰ **Technique Tip:** Reamer diameters start at 9 mm and increase by 1 mm increments up to 24 mm.

☰ **Note:** A 9 mm reamer reams 9 mm in true diameter.

Leave the reamer in place as it will serve as a stable aligned anchor for the distal femoral resection guide and the rest of the instrumentation necessary for the femoral bone preparation.

☰ **Technique Tip:** The largest reamer that can be completely buried for femoral preparation may be smaller than the reamer used to prepare for the final diameter and depth of the stem extension provisional and implant.

8 mm IM Step Drill
00-5978-014-00



NexGen Reamer
00-5125-010-09
See Profiler



Tibial Provisional
00-5981-037-01
See Profiler



Femoral Provisional/Cutting Guide
00-5995-013-91, Lt
00-5995-013-92, Rt
See Profiler



Straight Stem Extension Provisional
00-5989-010-10
See Profiler



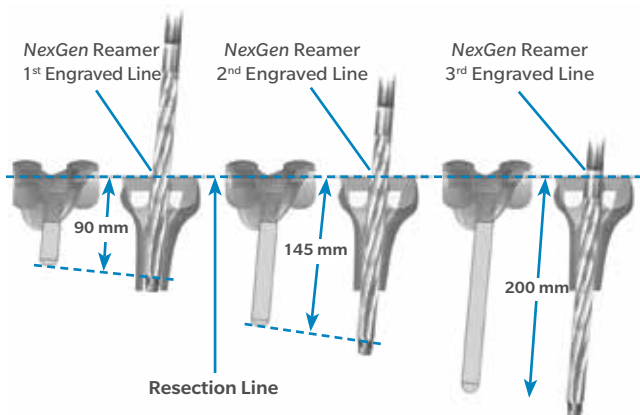

Figure 50

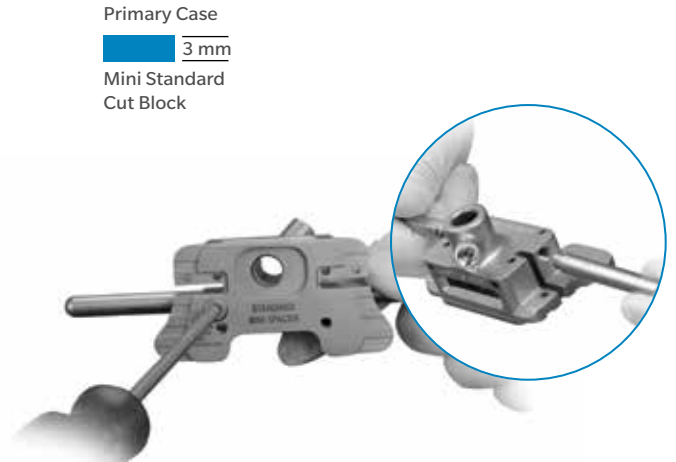

Figure 51

Prepare the Femoral Canal (cont.)

Please review Figure 50 for reaming depths prior to final provisional trialing.

- The 1st engraved line reams to the correct depth of 90 mm for a 75 mm NexGen Sharp Fluted Stem Extension.
- The 2nd engraved line reams to the correct depth for a 145 mm NexGen Stem Extension.
- The 3rd engraved line reams to the correct depth for the 200 mm NexGen Stem Extension.
- Laying the desired femoral provisional assembly next to the reamer, then marking the depth to ream with a marking pen can also aid in reaming depth visualization.

ⓘ Technique Tip: Note the diameter and depth reamed of the last reamer used once final reaming is complete.

Resect the Distal Femur

Screw the mini handles into the side of the appropriate LCCK 6° distal femoral guide (Figure 51).

To ensure a 6° valgus angle, attach the mini standard cut block (approximately 3 mm in thickness) to the appropriate 6° distal femoral guide (Figure 51). Ensure the proper “Left” or “Right” engraving is showing anteriorly.

ⓘ Note: If recutting the distal femur for a revision use the standard revision cut block (approximately 12 mm in thickness).

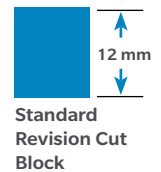

Mini Handle
00-5967-046-00



LCCK 6° Distal Femoral Guide
00-5987-061-01, Lt
00-5987-061-02, Rt



Mini Standard Cut Block
00-5967-045-00



Standard Revision Cut Block
00-5969-005-09





Figure 52



Figure 53



Figure 54

Resect the Distal Femur (cont.)

Slip the distal femoral guide assembly over the reamer or stem extension provisional assembly and align the mini handles with the epicondylar axis (Figure 52).

Use the 3.5 mm hex-head screwdriver to tighten the 6° distal femoral guide to the reamer or stem extension provisional assembly once it is in the desired rotation (Figure 53).

To check the varus/valgus alignment, insert the extramedullary alignment arch into the 6° distal femoral guide. Insert the alignment rod with coupler through the arch, passing it proximally toward the femoral head to verify proper instrument alignment (Figure 54).

ⓘ Technique Tip: For additional stability, 27 mm hex-head screws can be put in through the distal guide (see arrows Figure 52).

NexGen Reamer 00-5125-010-09 See Profiler 	Straight Stem Extension Provisional 00-5989-010-10 See Profiler 	Stem Provisional Adapter 00-5987-016-00 	3.5mm Hex-head Screwdriver 00-5987-089-00 	Extramedullary Alignment Arch 00-5977-024-00 	Alignment Rod with Coupler 00-5785-080-00 	MIS Screw Inserter/Extractor 00-5983-049-00 	Hex-headed Screws 00-5983-040-27, 27mm 
Mini Handle 00-5967-046-00 	LCCK 6° Distal Femoral Guide 00-5987-061-01, Lt 00-5987-061-02, Rt 	Mini Standard Cut Block 00-5967-045-00 	Standard Revision Cut Block 00-5969-005-09 	Tibial Provisional 00-5981-037-01 See Profiler 			



Figure 55

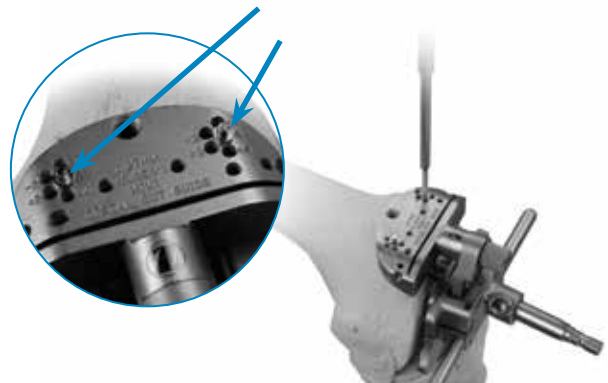

Figure 56

Resect the Distal Femur (cont.)

Attach the mini distal femoral cutting guide to the 0° distal placement guide (Figure 55) and slide the assembly into the 6° distal femoral guide.

Insert two 33 mm hex-headed screws through the holes marked “0” in the top of the cutting guide (see arrows Figure 56). Additional hex-headed screws or headless holding pins may be used for increased stability during cutting.

ⓘ Technique Tip: Leave the instrumentation in place for added fixation while making the majority of the distal cut.

<p>NexGen Reamer 00-5125-010-09 See Profiler</p> 	<p>Straight Stem Extension Provisional 00-5989-010-10 See Profiler</p> 	<p>Stem Provisional Adapter 00-5987-016-00</p> 	<p>Tibial Provisional 00-5981-037-01 See Profiler</p> 	<p>Mini Distal Femoral Cutting Guide 00-5967-036-00</p> 	<p>0° Distal Placement Guide 00-5967-031-00</p> 	<p>MIS Screw Inserter/Extractor 00-5983-049-00</p> 
<p>LCCK 6° Distal Femoral Guide 00-5987-061-01, Lt 00-5987-061-02, Rt</p> 	<p>Mini Standard Cut Block 00-5967-045-00</p> 	<p>Hex-headed Screws 00-5983-040-27, 27 mm 00-5983-040-33, 33 mm 00-5983-040-48, 48 mm</p> 				

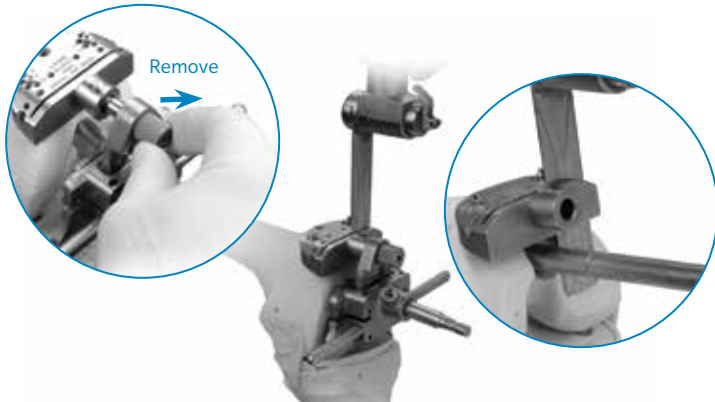

Figure 57

Resect the Distal Femur (cont.)

Use a 0.050 inch/1.27 mm oscillating saw blade to start the resection of the distal femur through the slot in the mini distal femoral cutting guide (Figure 57).

Loosen the thumb screw on the 0° distal placement guide.

Remove the 6° distal femoral guide and 0° distal placement guide from the reamer or stem extension provisional assembly and finish the cut (Figure 57).

Remove the mini distal femoral cutting guide, leaving the reamer or stem extension provisional assembly in place.

NexGen Reamer
00-5125-010-09
See Profiler



Straight Stem Extension Provisional
00-5989-010-10
See Profiler



Stem Provisional Adapter
00-5987-016-00



Tibial Provisional
00-5981-037-01
See Profiler



Mini Distal Femoral Cutting Guide
00-5967-036-00



MIS Screw Inserter/Extractor
00-5983-049-00



LCCK 6° Distal Femoral Guide
00-5987-061-01, Lt
00-5987-061-02, Rt



Hex-headed Screws
00-5983-040-27, 27 mm
00-5983-040-33, 33 mm
00-5983-040-48, 48 mm



Mini Standard Cut Block
00-5967-045-00



0° Distal Placement Guide
00-5967-031-00



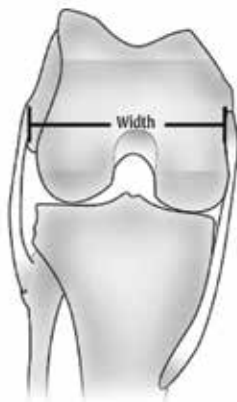

Transepicondylar Width (mm)	Female Size	Male Size
75	C	-
80	D	C
85	E	D
90	F	E
95	G	F
100	-	G

NexGen Femoral Component Size Related to the Transepicondylar Width

Figure 58

Evaluate Femoral Size

Epicondylar Width

The epicondylar width of the femur also aids in selecting the appropriate femoral size. Measure the width of the epicondyles and use the following chart to assist in defining the appropriate size (Figure 58). By measuring the epicondyles, the maximum size has been determined.

ⓘ Technique Tip: Evaluation of the preoperative x-ray of the patient’s other knee may help in making the final sizing decision.

Femoral Sizer

Place the mini A/P sizing guide flat on the smoothly cut distal femur so the feet are flush against the posterior condyles.

ⓘ Technique Tip: Check the position by looking through both windows of the mini A/P sizing guide to ensure the medullary canal is not visible through either.

Use the hex-headed screws to fix the mini A/P sizing guide to the distal femur.

Mini Distal Femoral Cutting Guide
00-5967-036-00



0° Distal Placement Guide
00-5967-031-00



LCCK 6° Distal Femoral Guide
00-5987-061-01, Lt
00-5987-061-02, Rt



Mini Standard Cut Block
00-5967-045-00



NexGen Reamer
00-5125-010-09
See Profiler



Straight Stem Extension Provisional
00-5989-010-10
See Profiler



Stem Provisional Adapter
00-5987-016-00



Hex-headed Screws
00-5983-040-27, 27 mm
00-5983-040-33, 33 mm
00-5983-040-48, 48 mm



MIS Screw Inserter/Extractor
00-5983-049-00



Tibial Provisional
0-5981-037-01
See Profiler





Figure 59



Figure 60

Evaluate Femoral Size (cont.)

ⓘ **Technique Tip:** Do not over tighten the screws or the anterior portion of the mini A/P sizing guide will not slide on the distal femur.

Attach the MIS locking boom to the mini A/P sizing guide. Lock the boom when it is appropriately positioned (Figure 59).

Read the femoral size directly from the guide between the engraved lines on the sizing tower (Figure 60).

ⓘ **Technique Tip:** If the indicator is between two sizes, the smaller size is typically chosen to help prevent excessive ligament tightness in flexion.

ⓘ **Technique Tip:** Although the mini A/P sizing guide has eight engraved sizes, the LCCK system only contains sizes C-G.

Mini A/P Sizing
Guide
00-5967-055-00



MIS Screw
Inserter/Extractor
00-5983-049-00



Hex-headed Screws
00-5983-040-27, 27 mm
00-5983-040-33, 33 mm
00-5983-040-48, 48 mm



MIS Locking Boom
00-5983-028-30



Tibial Provisional
00-5981-037-01
See Profiler





Figure 61



Figure 62

Verify Femoral Rotation and Position Using the 4-in-1 Instruments

If removed, reinsert the appropriate reamer or stem extension provisional assembly into the reamed canal (Figure 61).

ⓘ Technique Tip: The reamer or stem provisional adapter should have minimal distal protrusion.

Insert the 4-in-1 9–10 mm bushing into the appropriate size 4-in-1 femoral cut block.

Ensure that the proper “Right” or “Left” engraving is showing anteriorly. Also, verify the correct orientation with the IM canal by using the engraved axis to align the bushing.

Slide the LCKK 4-in-1 9–10 mm bushing/4-in-1 femoral cut block assembly over the reamer or stem extension provisional assembly (Figure 62). The 4-in-1 femoral cut block should be flush against the distal femur.

ⓘ Technique Tip: If the LCKK 4-in-1 femoral cut block does not sit flush, due to missing or poor quality bone on the condyles, consider adding distal femoral augment provisionals (5, 10, 15, or 20 mm).

NexGen Reamer
00-5125-010-09
See Profiler



Straight Stem Extension Provisional
00-5989-010-10
See Profiler



Stem Provisional Adapter
00-5987-016-00



Tibial Provisional
00-5981-037-01
See Profiler



LCKK 4-in-1 9–10 mm Bushing
00-5987-026-00



LCKK 4-in-1 Femoral Cut Block
00-5987-021-03
See Profiler



Distal Femoral Augment provisional
00-5987-090-05





Figure 64



Figure 63



Figure 65

Verify Femoral Rotation and Position Using the 4-in-1 Instruments (cont.)

Verify the alignment of the 4-in-1 femoral cut block by inserting the tabs of the revision rotational alignment guide into the posterior cut slot and aligning it with the transepicondylar axis (Figure 63).

Use the 3.5 mm hex-head screwdriver to tighten the 4-in-1 9–10 mm bushing to the reamer or stem extension provisional assembly (Figure 64).

ⓘ Technique Tip: The 15 and 20 mm distal femoral augment provisionals will block access through the screw fixation holes in the 4-in-1 femoral cut block.

Use two hex-headed screws to secure the 4-in-1 femoral cut block to the distal femoral bone (Figure 65).

If the 4-in-1 femoral cut block indicates a less than optimal position for the femoral component with the 9–10 mm bushing, the use of an offset stem extension will be required. Proceed to the “Offset Stem Technique” on the following page to determine the stem alignment with optimal coverage.

NexGen Reamer 00-5125-010-09 See Profiler	Straight Stem Extension Provisional 00-5989-010-10 See Profiler	Stem Provisional Adapter 00-5987-016-00	LCKK 4-in-1 Femoral Cut Block 00-5987-021-03 See Profiler	LCKK 4-in-1 9–10 mm Bushing 00-5987-026-00	Tibial Provisional 00-5981-037-01 See Profiler	Rotational Alignment Guide 00-5987-051-01
						
3.5 mm Hex-head Screwdriver 00-5987-089-00	MIS Screw Inserter/Extractor 00-5983-049-00	Hex-headed Screws 00-5983-040-27, 27mm 00-5983-040-33, 33mm 00-5983-040-48, 48mm				
						

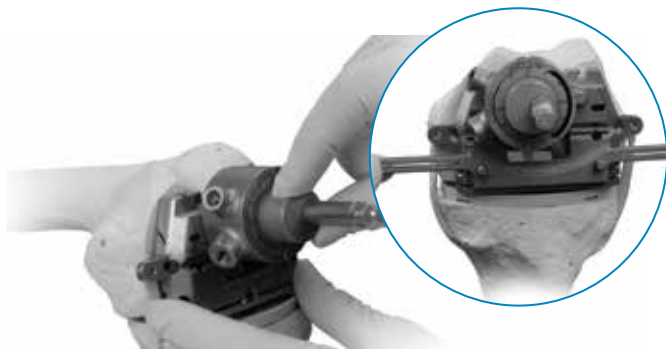

Figure 66



Figure 67

Offset Stem Technique

Insert the femoral offset bushing into the LCCK straight/offset bushing adapter.

Remove the headless holding pins, if used.

Insert the straight/offset bushing adapter and the femoral offset bushing into the appropriate size 4-in-1 femoral cut block.

Ensure that the proper “Right” or “Left” engraving is showing anteriorly. Also, verify the correct orientation with the IM canal by using the engraved axis to align the bushing.

Slide the straight/offset bushing adapter/4-in-1 femoral cut block assembly over the reamer or stem extension provisional assembly.

Rotate the femoral offset bushing within the straight/offset bushing adapter until an optimal position is determined (Figure 66).

Verify the adjustment of the 4-in-1 femoral cut block by inserting the revision rotational alignment guide into the posterior cut slot and aligning it with the transepicondylar cuts.

Use the 3.5 mm hex-head screwdriver to tighten the straight/offset bushing adapter to the femoral offset bushing (Figure 67). This will ensure that the correct rotation reading is maintained.

Femoral Offset Bushing
00-5987-014-00



Straight/Offset Bushing Adapter
00-5987-025-00



LCCK 4-in-1 Femoral Cut Block
00-5987-021-03
See Profiler



NexGen Reamer
00-5125-010-09
See Profiler



Straight Stem Extension Provisional
00-5989-010-10
See Profiler



Stem Provisional Adapter
00-5987-016-00



Tibial Provisional
00-5981-037-01
See Profiler



Rotational Alignment Guide
00-5987-051-01



3.5mm Hex-head Screwdriver
00-5987-089-00



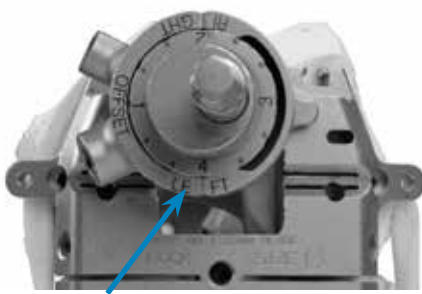

Figure 68

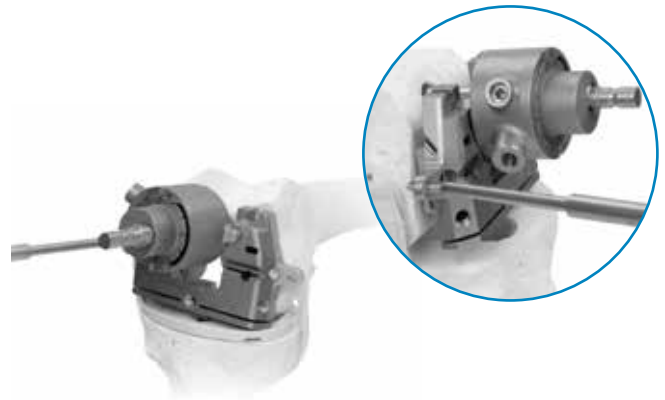

Figure 69

Offset Stem Technique (cont.)

ⓘ Technique Tip: The reading on the femoral offset bushing should be taken from the engraved line on the posterior face of the straight/offset bushing adapter (see arrow Figure 68). This reading will be used to set the provisional and implant offset stem rotations.

ⓘ Technique Tip: The inside screw holes should be used for all primary cases that do not require distal femoral augments. The outside screw holes should be used with 5 mm or 10 mm distal femoral augment provisionals (Figure 69).

Use two hex-headed screws to secure the 4-in-1 femoral cut block to the distal femoral bone (Figure 69).









Femoral Offset Bushing 00-5987-014-00 	Straight/Offset Bushing Adapter 00-5987-025-00 	LCCK 4-in-1 Femoral Cut Block 00-5987-021-03 See Profiler 	NexGen Reamer 00-5125-010-09 See Profiler 	Straight Stem Extension Provisional 00-5989-010-10 See Profiler 	Stem Provisional Adapter 00-5987-016-00 	Tibial Provisional 00-5981-037-01 See Profiler 	Rotational Alignment Guide 00-5987-051-01 
3.5mm Hex-head Screwdriver 00-5987-089-00 							



Figure 70

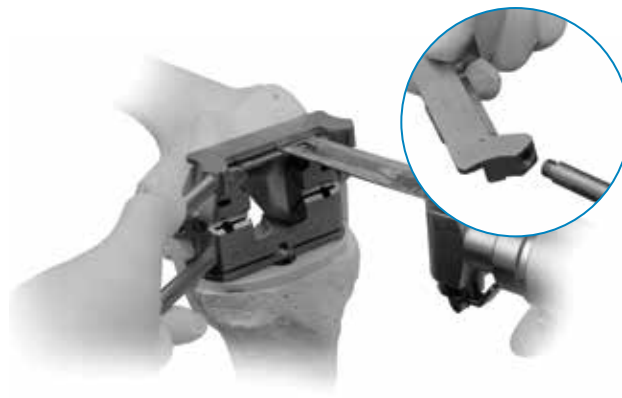

Figure 71

Make the Anterior Cut

Remove the 4-in-1 9–10 mm bushing or the straight/offset bushing adapter and femoral offset bushing.

Remove the reamer or stem extension provisional assembly.

Lay the resection guide on top of the 4-in-1 femoral cut block, and check the medial and lateral sides to be sure the cut will not notch the anterior cortex (Figure 70).

Attach the mini handles to the LCCK anterior cut guide (Figure 71).

Slide the anterior cut guide into the keyed slots in the 4-in-1 femoral cut block (Figure 71).

ⓘ Technique Tip: Hold the mini handles on the anterior cut guide and the 4-in-1 femoral cut block for added stability while cutting.

Use a 0.050 inch/1.27 mm oscillating saw to clean up the anterior condyles (Figure 71).

Distal Femoral Augment Provisional 00-5987-090-05 See Profiler 	LCCK 4-in-1 Femoral Cut Block 00-5987-021-03 See Profiler 	Tibial Provisional 00-5981-037-01 See Profiler 	Straight/Offset Bushing Adapter 00-5987-025-00 	Femoral Offset Bushing 00-5987-014-00 	MIS Screw Inserter/Extractor 00-5983-049-00 	Hex-headed Screws 00-5983-040-27, 27mm 00-5983-040-33, 33mm 00-5983-040-48, 48mm 
Resection Guide 00-5977-084-00 	Mini Handle 00-5967-046-00 	LCCK Anterior Cut Guide 00-5987-023-00 				

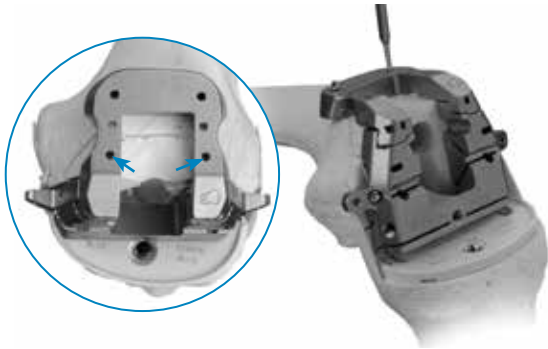

Figure 72



Figure 73

Make the Posterior Cut

Remove the anterior cut guide.

ⓘ Technique Tip: The A/P position of the LCCK notch cut guide/4-in-1 femoral cut block assembly is determined by the orientation of the medullary canal. Therefore, the anterior flange of the guide is not designed to sit flush with the cut surface of the anterior femoral bone.

Insert the appropriate size LCCK notch cut guide until fully seated in the 4-in-1 femoral cut block.

ⓘ Technique Tip: The first set of holes on the notch cut guide should not be used if any augmentation is used on the 4-in-1 femoral cut block (see arrows Figure 72).

Use two 33 mm hex-head screws for fixation (Figure 72).

Use the oscillating saw to clean-up the posterior condyles (Figure 73).

ⓘ Technique Tip: For sizes C and D, if snap-in distal augments have been used, care must be taken to avoid the peg if it enters the slot with the saw blade (see arrows Figure 73).

LCCK Anterior
Cut Guide
00-5987-023-00



LCCK Notch Cut
Guide
00-5987-022-01
See Profiler



LCCK 4-in-1 Femoral
Cut Block
00-5987-021-03
See Profiler



Tibial Provisional
00-5981-037-01
See Profiler



Distal Femoral
Augment Provisional
00-5987-090-05
See Profiler



MIS Screw Inserter/
Extractor
00-5983-049-00



Hex-headed Screws
00-5983-040-27, 27mm
00-5983-040-33, 33mm
00-5983-040-48, 48mm



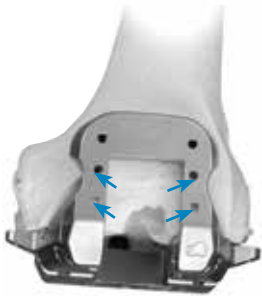

Figure 74



Figure 75



Figure 76

Make the Chamfer Cuts

ⓘ Technique Tip: If screws were put in the first two sets of holes on the LCCK notch cut guide, they will need to be removed prior to making the anterior chamfer cut (Figure 74).

Use a reciprocating saw or an oscillating saw to cut the anterior and posterior chamfers (Figure 75).

Make the LCCK Box Cut

Use the reciprocating saw to cut the sides and base of the LCCK box (Figure 76).

LCCK Anterior Cut Guide
00-5987-023-00



LCCK Notch Cut Guide
00-5987-022-01
See Profiler



LCCK 4-in-1 Femoral Cut Block
00-5987-021-03
See Profiler



Tibial Provisional
00-5981-037-01
See Profiler



Distal Femoral Augment Provisional
00-5987-090-05
See Profiler



MIS Screw Inserter/Extractor
00-5983-049-00



Hex-headed Screws
00-5983-040-27, 27mm
00-5983-040-33, 33mm
00-5983-040-48, 48mm





Figure 77

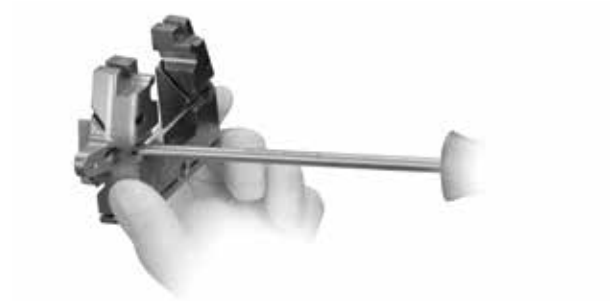

Figure 78

Drill the Femoral Stem Base

If the canal is not already reamed to 18 mm use the LCCK 18 mm femoral drill bushing to drill to the indicated depth for an LCCK femoral component.

Attach the MIS threaded handle to the 18 mm femoral drill bushing (Figure 77).

Ensure that the proper “Right” or “Left” engraving is showing anteriorly. Also, verify the correct orientation with the IM canal by using the engraved axis to align the bushing.

Insert the LCCK 18 mm femoral drill bushing into the 4-in-1 femoral cut block.

Drill the canal to the second engraved line for an LCCK Femoral Component. The depth for an LCCK Component is indicated on the drill bit (Figure 77).

ⓘ Technique Tip: When removing the femoral augment provisionals from any instrument, use the 3.5 mm hex-head screwdriver to push the peg of the augment from the opposite side (Figure 78).

LCCK 4-in-1 Femoral Cut Block
00-5987-021-03
See Profiler



LCCK Notch Cut Guide
00-5987-022-01
See Profiler



Hex-headed Screws
00-5983-040-27, 27mm
00-5983-040-33, 33mm
00-5983-040-48, 48mm



MIS Threaded Handle
00-5983-002-01



LCCK 18mm Femoral Drill Bushing
00-5987-024-00



18mm Femoral Stem Drill
00-5987-010-01



Distal Femoral Augment Provisional
00-5987-090-05
See Profiler



3.5mm Hex-head Screwdriver
00-5987-089-00





Figure 79



Figure 80

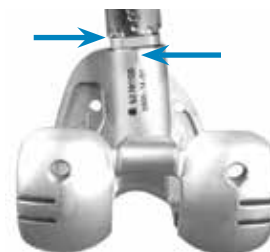

Figure 81

Perform Trial Reduction

Slide the appropriate size modular box provisional onto the femoral provisional/cutting guide (Figure 79).

Attach the appropriate posterior femoral augment provisionals, then the distal femoral augment provisionals (Figure 79).

If distal femoral augmentation is not necessary, use a femoral augment provisional screw to secure the provisional box (Figure 79).

ⓘ Technique Tip: The modular box provisional is angled to match the bone cut. The provisional box does not match the femoral implant.

If necessary, use the appropriate anterior femoral augment provisional.

Assemble the stem extension provisional to the femoral provisional/cutting guide (Figure 80).

ⓘ Technique Tip: If it was determined an offset stem extension would be needed, fully thread the offset locknut onto the appropriate size offset stem extension provisional and thread it into the femoral provisional/cutting guide. Rotate the offset stem extension provisional to the position noted earlier on the femoral offset bushing (page 37 Figure 68) and back thread the locknut until it engages the first thread. Use the offset stem wrench to tighten the locknut against the provisional stem once it is lined up correctly with the posterior mark on the stem base (Figure 81).

Insert the femoral provisional/cutting guide assembly onto the bone to check for proper fit.

Modular Box Provisional 00-5995-013-00 See Profiler 	Femoral Provisional/Cutting Guide 00-5995-013-91, Lt 00-5995-013-92, Rt See Profiler 	Posterior Femoral Augment Provisional 00-5987-089-05 See Profiler 	Distal Femoral Augment Provisional 00-5987-090-05 See Profiler 	Femoral Augment Provisional Screw 00-5987-085-00 	3.5mm Hex-head Screwdriver 00-5987-089-00 	Anterior Femoral Augment Provisional 00-5989-033-31 See Profiler 	
Straight Stem Extension Provisional 00-5989-010-10 See Profiler 	Offset Stem Extension Provisional 00-5989-020-11 See Profiler 	Offset Stem Locknut 00-5987-080-00 	Offset Stem Wrench 00-5987-079-00 				



Figure 82



Figure 83

Establish Flexion Gap and Stability

Insert the correct size and style of tibial provisional with the selected tibial augment provisional, if needed, and stem extension provisional.

Begin by inserting the thinnest LPS articular surface provisional of the color indicated on the tibial provisional and femoral provisional.

When implanting an LCCK femoral component, insert the LPS articular surface provisional. If more constraint is needed, remove the LPS provisional and insert the LCCK articular surface provisional. For either the LPS or LCCK articular surface provisional, insert the locking screw through the articular surface and tighten with the 3.5 mm hex-head screwdriver, if desired (Figure 82).

Evaluate the stability in flexion (Figure 83).

If the thinnest articular surface cannot be inserted consider the following:

- Downsize the femoral component
- Lower the tibial plateau/joint line

If the thinnest articular surface does not tense the flexion gap adequately, insert progressively thicker articular surface provisionals until adequate stability is obtained.

**Femoral Provisional/
Cutting Guide**
00-5995-013-91, Lt
00-5995-013-92, Rt
See Profiler



**LPS Articular
Surface Provisional**
00-5961-030-10
See Profiler



**LCCK Articular
Surface Provisional**
00-5995-022-10
See Profiler



Tibial Provisional
00-5981-037-01
See Profiler



**Straight Stem
Extension Provisional**
00-5989-010-10
See Profiler



**Articular Surface
Provisional
Locking Screw**
00-5995-075-00



**3.5mm Hex-head
Screwdriver**
00-5987-089-00



**Distal Femoral
Augment Provisional**
00-5987-090-05
See Profiler



NexGen Legacy Knee Constrained Condylar LCCK

		Femoral Size				
		C	D	E	F	G
Tibial Size	1-2	SP CD/1-2	SP CD/1-2	E/1-2*		
	3-4	Y CD/3-4	Y CD/3-4	SY EF/3-4	SY EF/3-4	G/3-4*
	5-6	SG CD/5-6	SG CD/5-6	G EF/5-6	G EF/5-6	SG G/5-6
	7-10			SB EF/7-10	SB EF/7-10	B G/7-10
Patella Size		Use Standard Size Patellas with all LCCK Femoral Components				
		26 mm (inset only)†	32 mm†			
		38 mm	29 mm†			
		35 mm	41 mm			

Color Key
 P = Purple
 Y = Yellow
 G = Green
 B = Blue
 SP = Striped Purple
 SP = Striped Blue
 SY = Striped Yellow
 SG = Striped Green

† For G Femoral Components, the 26, 29 and 32 mm patellar components must be inset.

*LPS-Flex Prolong® Polyethylene Articular Surface Only

Establish Flexion Gap and Stability (cont.)

If the thickest articular surface does not tense the flexion gap consider the following:

- Augment the tibial provisional with a 5 mm or 10 mm block on both the medial and lateral sides
- Select the next larger femoral provisional/ cutting guide

The color key for matching components within the LCCK system which follows should be used.

NexGen Complete Knee Solution
Component Matching Flowchart

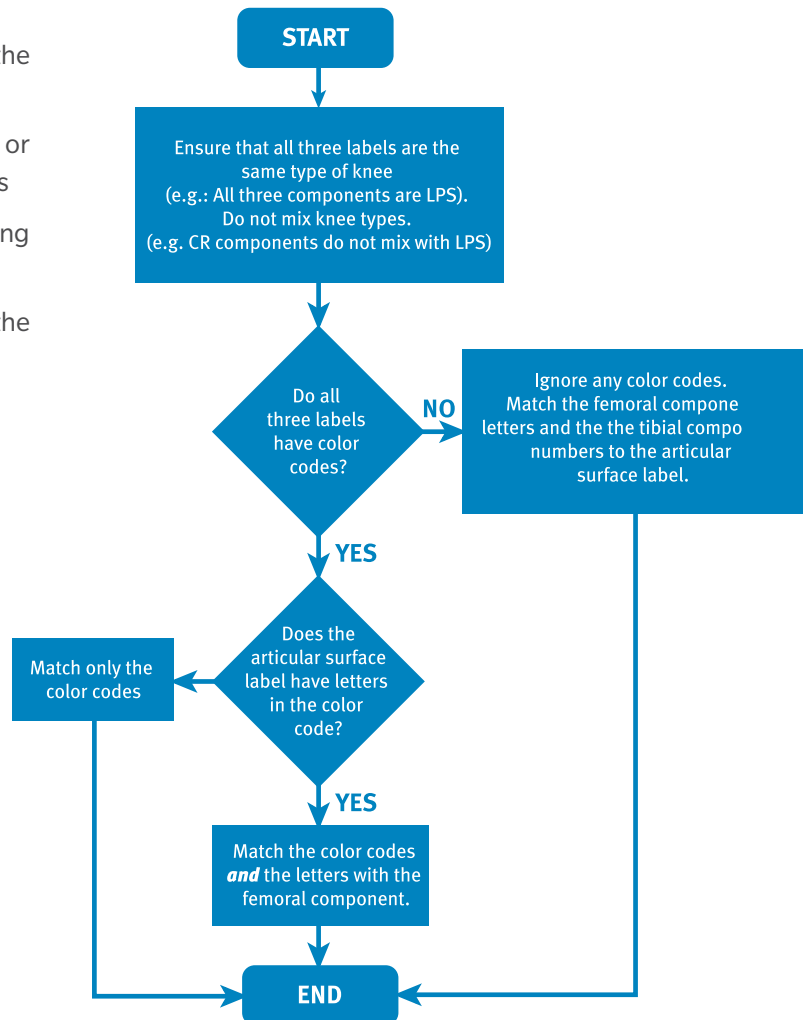

Primary Technique - Stabilize the Knee in Extension



Figure 84



Figure 85

Establish Extension Gap and Stability

After achieving the appropriate stability in flexion, leave the final LPS articular surface provisional in place and bring the knee to full extension. A symmetrical and balanced extension gap should be created.

As the revision knee arthroplasty is extended, assess the full extension, the desired valgus alignment, and adequate varus/valgus stability (Figure 84).

☰ Technique Tip: The distal femoral augment provisionals may be used as spacers to create added stability in extension (Figure 85).

If the gap exceeds the maximum augment available, 20 mm, then evaluate the next smaller femoral provisional size. This will allow the use of a thicker articular surface provisional and will necessitate a reassessment of the flexion gap.

Balance Soft Tissues

Unless large deformities are due exclusively to bone loss and the subsidence of the components, conventional soft tissue releases will be necessary.

With the knee in extension, perform the necessary ligament releases to achieve symmetric and adequate tension.

**Femoral Provisional/
Cutting Guide**
00-5995-013-91,Lt
00-5995-013-92,Rt
See Profiler



**Straight Stem
Extension Provisional**
00-5989-010-10
See Profiler



**LPS Articular
Surface Provisional**
00-5996-030-10
See Profiler



Tibial Provisional
00-5981-037-01
See Profiler



**Distal Femoral
Augment Provisional**
00-5987-090-05
See Profiler



**Posterior Femoral
Augment Provisional**
00-5987-089-05
See Profiler



Balance Flexion/Extension Gaps

It is important to remember that adjustments to the femoral side of the arthroplasty can affect the knee in either flexion or extension, while any change to the tibia affects both flexion and extension. This is part of the rationale for reconstructing the tibial side of the joint first. The following matrix (Figure 86) suggests the nine situations that can occur during a trial reduction in a revision knee.

🔊 **Technique Tip:** Perform a trial reduction after implementing any of these solutions. This will verify the solution or identify any new problems and/or a variation of the initial problem that may still exist.

		Extension		
		Tight	OK	Loose
Flexion	Tight	1	2	3
	OK	4	5	6
	Loose	7	8	9

Figure 86

1. Two options exist

- Use a thinner articular surface.
- Resect more tibia.

2. Three options exist

- Use an offset stem extension to move the femoral component anteriorly.
- Use a smaller femoral component.
- Use a distal femoral augment to move the femoral component distally and use a thinner articular surface.

3. Three options exist

- Use a distal femoral augment to lower the joint line and allow use of a thinner articular surface.
- Use a thicker articular surface and use a smaller femoral component.
- Use an offset stem extension to move the femoral component anteriorly and use a thicker articular surface.

4. Two options exist

- Release the posterior capsule from the femur.
- Resect additional distal femoral bone and move the femoral component proximally.

5. No further modification is necessary**6. Two options exist**

- Use a distal femoral augment with the same articular surface. This drops the joint line and tightens the extension gap.
- Downsize the femoral component and use a thicker articular surface. This will probably raise the joint line.

7. Three options exist

- Resect additional distal femoral bone and use a larger femoral component with posterior femoral augments.
- Resect additional femoral bone and use a thicker articular surface with a more proximal femoral position.
- Resect additional distal femoral bone and use an offset stem extension to move the femoral component posteriorly. Use posterior femoral augments.

8. Four options exist

- Use a larger femoral component with posterior femoral augments. This may equalize gaps.
- Resect additional distal femoral bone and use a thicker articular surface with a more proximal femoral position.
- Use an offset stem extension to move the femoral component posteriorly. Use posterior femoral augments.
- Choose to accept the current balance if it is only of a mild degree, particularly in a highly constrained component.

9. Use a thicker Articular Surface

Always consider the position of the patella and joint line in the final soft tissue balancing.

Prepare the Patella



Figure 87



Figure 88

Prepare the Patella

It is not always necessary to revise the patellar component. A well-fixed component from the NexGen system may be left. If the component is loose or found to be incompatible, determine if there is enough bone remaining to implant a new patellar component. The NexGen patellar component requires a minimum of 11 mm of remaining bone to allow for the implant pegs (Figure 87).

If the decision is made to replace the primary patellar component with a NexGen patellar component, prepare the patellar peg holes by centering the appropriate patellar drill guide over the patella. It may be necessary to rotate the guide to find the best location for fixation.

Holding the guide firmly in place, drill the three peg holes using the patellar/femoral drill bit.

If inadequate bone remains, trim the surface and either leave the residual bone or consider use of a patellar component that has been designed to compensate for defects in the patella (Figure 88).

Patellar Drill Guide
00-5979-001-26
See Profiler

Patellar/Femoral Drill Bit
00-5120-052-01





Figure 89



Figure 90

Prepare the Patella (cont.)

To compensate for gross bone deficiency, the NexGen Augmentation Patella* provides the additional option of suturing the patella base to the extensor tendon to provide adjunctive fixation (Figure 89). Refer to the NexGen Augmentation Patella Surgical Technique for additional information.

Patellar Tracking

Evaluate the tracking of the patellar provisional against the femoral provisional/cutting guide.

The patella must track centrally. Simulate closure of the capsule with either a single suture or by attaching a towel clip. If additional pressure is needed to hold the patella reduced, or if the patella tends to sublax or tilt laterally, perform a lateral retinacular release. Be careful not to create any defect in the skin. Extend the release until the patella tracks satisfactorily. If a lateral retinacular release fails to correct patellar tracking reassess the rotation of the femoral and tibial components. Also check the orientation of the tibial tubercle.

Insert the patellar provisional. With all provisionals in place, check the range of motion and joint stability (Figure 90).

Perform any necessary soft tissue releases.

Remove all provisionals.

*Indicated for use with bone cement in the USA.

Patellar Provisional
00-5971-065-26
See Profiler



**Femoral Provisional/
Cutting Guide**
00-5995-013-91,Lt
00-5995-013-92,Rt
See Profiler



**LCKK Articular
Surface Provisional**
00-5995-022-10
See Profiler



Tibial Provisional
00-5981-037-01
See Profiler



Component Implantation

After the implants have been chosen, make one last check to ensure that the femoral, tibial, and articular surface components match. There should be a three-of-a-kind color match between the squares on each box.

🔑 **Technique Tip:** The tibial component, if implanted first, does not compromise access to the femoral component. However, implantation of the femoral component first may compromise access for the tibial component.

Tibial Component Preparation

Tibial augments are designed to be secured to the tibial plate with screws or bone cement. As with the stem extensions, the augment screws are packaged with the augment. If cement is used to attach the augment, use the augment assembly clamp to stabilize the augment while the cement is curing. All augments are PMMA precoated to enhance fixation to the bone cement.

There are two techniques for inserting the articular surface onto the tibial plate.

The recommended method is to assemble and tighten the articular surface, tibial plate, and stem extension on the back table.

The alternative method is to insert the articular surface intraoperatively, after the tibial plate has been cemented.

Augment
Assembly Clamp
00-5977-030-00

Augment Holding
Clamp Head
00-5987-086-00



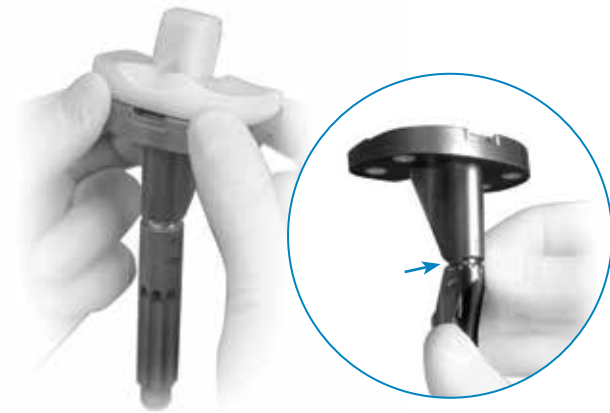

Figure 91

Technique 1: “Back Table” Technique (Recommended)

Remove the locking screw from the stem extension implant and discard. The locking screw that will be used is packaged with the LCKK articular surface implant.

Insert the stem extension implant into the base of the tibial plate implant.

When using an offset stem extension, use the stem location referenced earlier and line up that stem location number with the etched line on the anterior distal tibial component (Figure 91).

Wrap the tibial component in a cloth and place it on a surgical cart.

The surgical cart will provide a rigid surface on which to impact the taper and assure that the impact is delivered to the taper connection and it is full seated.

⚠ Caution: Hitting the stem more than once may loosen the taper connection.

While protecting the stem extension, strike it solidly one time with a two-pound mallet. The two-pound mallet will assure the proper amount of impact force is delivered to the taper connection.

By hand, assemble the LCKK articular surface onto the implant tray applying downward and posterior force (Figure 91).





Figure 92



Figure 93



Figure 94

Technique 1: “Back Table” Technique (Recommended)

ⓘ **Technique Tip:** The articular surface must be completely seated in the tibial tray prior to torquing the screw. The screw is not intended to pull the articular surface down into the tibial plate.

Insert the locking screw packaged with the LCCK articular surface, and hand tighten with the 4.5 mm hex driver bit (Figure 92).

Leave the driver bit set in the screw head.

Select the LCCK tibial plate wrench that has the stem extension diameter that matches that of the Implant to be assembled.

Insert the stem extension through the stem protector sleeve and into the hole in the wrench that corresponds to the stem extension diameter.

ⓘ **Caution:** Do not over or under torque. Under tightening of the screw may allow it to loosen over time. Over tightening may cause the screw to fracture intraoperatively.

Attach the deflection beam torque wrench to the 4.5 mm hex driver bit (Figure 93).

Apply 95 in. lbs. of torque with the wrench to assure the screw is properly tightened (Figure 93).

For cemented applications, a layer of cement should be placed on the underside of the tibial plate, around the keel, on the resected tibia surfaces, and in the tibial IM canal (Figure 94).

Implant the tibial plate and stem extension.

Remove any excess bone cement from the implant/bone interface.

4.5mm Hex
Driver Bit
00-5987-036-00



Tibial Plate
Wrench
00-5995-037-01
See Profiler



Stem Protector
Sleeve
00-5987-038-00



Deflection Beam
Torque Wrench
00-5987-035-00



Technique 2: Intraoperative Technique

⊖ Caution: Use of this technique risks disturbing the bone/cement/implant interface.

Remove the locking screw from the stem extension implant and set it on the back table for later use.

Insert the stem extension implant into the tibial plate implant. When using an offset stem extension, use the stem location referenced earlier and line up that stem location number with the etched line on the anterior distal tibial component.

Wrap the tibial component in a cloth and place it on a surgical cart. The surgical cart will provide a rigid surface on which to impact the taper and assure that the impact is delivered to the taper connection and it is full seated.

⊖ Caution: Hitting the stem more than once may loosen the taper connection.

While protecting the stem extension, strike it solidly one time with a two-pound mallet. The two pound mallet will assure the proper amount of impact force is delivered to the taper connection.

Mallet
00-0155-002-00



3.5mm Hex-head
Screwdriver
00-5987-089-00



4.5mm Hex
Driver Bit
00-5987-036-00



Tibial Plate Wrench
00-5995-037-01
See Profiler



Technique 2: Intraoperative Technique (cont.)

Insert the locking screw packaged with the stem extension and hand tighten it with the 3.5 mm hex-head screwdriver. This will serve as a temporary screw which will be replaced upon insertion of the LCCK articular surface implant.

For cemented applications, a layer of cement should be placed on the underside of the tibial base plate, around the keel, on the resected tibia surfaces, and in the tibial IM canal (Figure 90 on page 49).

Implant the tibial plate and stem extension. Remove any excess bone cement from the implant/bone interface.

ⓘ Technique Tip: Cement must be cured prior to using this technique. If a leg holder is used, the leg should be removed, and be free to rotate. This will promote proper tibial plate wrench use and help prevent loads from developing at the bone/cement/implant interface.

Mallet
00-0155-002-00



**3.5mm Hex-head
Screwdriver**
00-5987-089-00



**4.5mm Hex
Driver Bit**
00-5987-036-00



Tibial Plate Wrench
00-5995-037-01
See Profiler





Figure 95

Technique 2: Intraoperative Technique (cont.)

Remove the temporary locking screw from the stem extension.

By hand, assemble the LCCK articular surface onto the implant tray applying downward and posterior force.

Insert the locking screw packaged with the LCCK articular surface and hand tighten it with the 4.5 mm hex driver bit. Leave the driver bit set in the screw head.

Select the LCCK tibial plate wrench that has the tibial plate size that matches that of the implant to be assembled.

Place the end of the wrench over the tibial plate. Ensure that the wrench is in line with the base of the tibial plate.

⚠ Caution: Do not over or under torque. Under tightening of the screw may allow it to loosen over time. Over-tightening may cause the screw to fracture intraoperatively.

Attach the deflection beam torque wrench to the 4.5 mm hex driver bit (Figure 95).

Apply 95 in. lbs. of torque with the wrench to assure the screw is properly tightened (Figure 95).

**4.5mm Hex
Driver Bit**
00-5987-036-00



**Tibial Plate
Wrench**
00-5995-037-01
See Profiler



**Deflection Beam
Torque Wrench**
00-5987-035-00



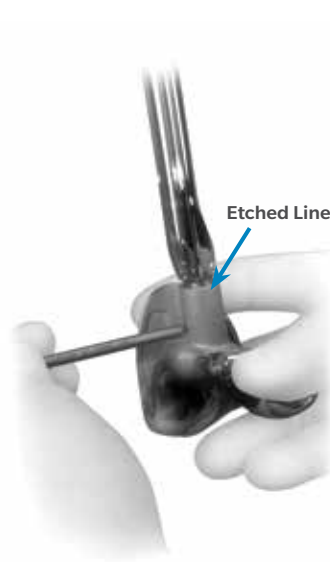

Figure 96

Femoral Component Preparation

Stem Extension

It is required that a stem extension always be used with an LCCK femoral component.

The locking mechanism between the femoral implant and the stem extension implant is a combination of a Morse-type taper and two set screws.

Remove the stem extension locking screw from the stem extension and discard. The stem extension screw is not used with the femoral component.

Check to ensure that the set screws have not migrated or fallen into the femoral stem base taper prior to inserting the stem extension.

Insert the stem extension into the base of the femoral component.

When using the offset stem extension, use the stem location referenced earlier and line up that stem location number with the etched line on the posterior stem base housing (Figure 96).

The stem extension should be “snug” in the femoral component base. If toggle exists, back out one or both of the set screws one half turn.

When a “snug” fit is achieved, wrap the femoral component in a cloth and place it on a surgical cart.

⊖ Caution: Hitting the stem more than once may loosen the taper connection.

While protecting the stem extension, strike it solidly one time with a two-pound mallet.

⊖ Caution: The femoral set screw hex driver is designed to limit the amount of torque which can be applied to the set screws. Torque by hand only.

After seating the Morse-type taper, tighten the two set screws located in the base of the femoral component. Use the femoral set screw hex driver and apply moderate torque to tighten each of the two set screws (Figure 96).

Mallet
00-0155-002-00



Femoral Set Screw
Hex Driver
00-5987-071-00

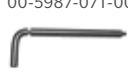



Figure 97

Attachment of Augments

When using multiple augments, the order in which they are positioned is important. The distal femoral augments must be positioned first, followed by the posterior femoral augments, and then the anterior femoral augment.

- ⓘ **Note:** Augment options can be found within Appendix A – Augment Compatibility.
- ⓘ **Technique Tip:** Posterior-only and distal-only augments are not to be used in combination with other distal or posterior augments, as they were not designed to be used together.

The locking mechanism between the femoral implant and the femoral augment implant is a single fixation screw (except the anterior augment which is cemented only). The fixation screw is packaged with the augment.

The augment starter screwdriver can be used to assist in “starting” the screws through the augments into the femoral component (Figure 97). Final tightening of the attachment screw must be done with the 3.5 mm hex-head screwdriver.

Augments may also be cemented in place and are precoated for enhanced cement fixation.

If augments are to be cemented, apply cement between the augment and femoral component, around the sides of each augment, and to the rails of the femoral component.

Use the femoral augment holding clamp head with the augment assembly clamp to achieve intimate contact between the augment and the femoral component until the cement is cured.

Implant the femoral component and stem extension. Cement may be applied to the posterior condyles of the femoral component. More cement will usually be required than in the fixation of a primary component because of larger voids. Cement is prevented from entering the medullary canal, but is applied around the intercondylar housing and stem base of the femoral component.

Femoral Augment
Starter Screwdriver
00-5987-092-03



3.5mm Hex-head
Screwdriver
00-5987-089-00



Augment
Assembly Clamp
00-5977-030-00



Augment Holding
Clamp Head
00-5987-086-00



Attachment of Augments (cont.)

Full cementation of the stem extension is possible, but is usually avoided because of the anticipated difficulty of later cement removal and the enhanced capability of solid press fit with the wide selection of stem lengths, diameters, and offset geometries.

In some patients with poor bone quality, or in low-demand patients where large bone defects are filled with cement, full cement fixation can be used. In these situations, the medullary canal should be prepared attentively, with techniques used in hip arthroplasty such as pulsate lavage, packaging and pressurization. Narrow diameter, standard length stems should be used for this technique.

Appendix A-Augment Compatibility

Tibial Augment Compatibility (cont.)

		NexGen Finned Precoat Tibial Augments																																		
	Size	Full Block (10 mm)								Half Block (5 mm)								Half Block (10 mm)								Half Block Tapered (15 mm) Right-Lateral/Left-Medial										
		1	2	3	4	5	6	7	8	1	2	3	4	5	6	7	8	1	2	3	4	5	6	7	8	1	2	3	4	5	6	7	8			
NexGen Tibial Baseplates	Stemmed (Precoat)	1	C							C								C									C									
		2		CS							CS									CS								CS								
		3			CS							CS										CS								CS						
		4				CS							CS										CS								CS					
		4+				CS							CS											CS							CS					
		5					CS							CS											CS							CS				
		6						CS							CS											CS						CS				
		7							CS							CS											CS						CS			
		8								CS							CS											CS						CS		
		9																																		
10																																				
NexGen Tibial Baseplates	A/P Wedge Stemmed (Precoat)	3				CS							CS																CS							
		4					CS							CS																CS						
		5						CS							CS																CS					
		6							CS							CS																CS				
		7								CS							CS																CS			
		8									CS							CS															CS			

		NexGen Finned Precoat Tibial Augments (Continued)																																		
	Size	Half Block Tapered (15 mm) Left-Lateral/Right-Medial								Half Block Tapered (20 mm) Right-Lateral/Left-Medial								Half Block Tapered (20 mm) Left-Lateral/Right-Medial								Half Wedge (16°)										
		1	2	3	4	5	6	7	8	1	2	3	4	5	6	7	8	1	2	3	4	5	6	7	8	2	3	4	5	6	7	8				
NexGen Tibial Baseplates	Stemmed (Precoat)	1	C							C								C																		
		2		CS							CS									CS									CS							
		3			CS							CS										CS								CS						
		4				CS							CS										CS								CS					
		4+				CS							CS											CS							CS					
		5					CS							CS											CS							CS				
		6						CS							CS											CS						CS				
		7							CS							CS											CS						CS			
		8								CS							CS											CS						CS		
		9																																		
10																																				
NexGen Tibial Baseplates	A/P Wedge Stemmed (Precoat)	3					CS							CS																CS						
		4						CS							CS																CS					
		5							CS							CS																CS				
		6								CS							CS															CS				
		7									CS							CS															CS			
		8										CS							CS														CS			

CS: Cement or Screw Attachment
 C: Cement Attachment Only

Appendix A-Augment Compatibility (cont.)

Tibial Augment Compatibility (cont.)

NexGen Finned Precoat Tibial Augments (Continued)																									
		Half Wedge (26°)							Third Wedge (22°)							Full Wedge (7°)									
Size		2	3	4	5	6	7	8	2	3	4	5	6	7	8	2	3	4	5	6	7	8	9		
NexGen Tibial Baseplates	Stemmed (Precoat)	1																							
		2	CS							CS							CS								
		3		CS							CS							CS							
		4			CS							CS							CS						
		4+			CS							CS							CS						
		5				CS							CS							CS					
		6					CS							CS							CS				
		7						CS							CS							CS			
		8							CS							CS							CS		
		9																						CS	
10																									
A/P Wedge Stemmed (Precoat)	3		CS							CS							CS								
	4			CS							CS							CS							
	5				CS							CS							CS						
	6					CS							CS							CS					
	7						CS							CS							CS				
	8							CS							CS							CS			

CS: Cement or Screw Attachment
 C: Cement Attachment Only

Appendix A-Augment Compatibility (cont.)

Femoral Augment Compatibility (cont.)

NexGen Finned Precoat Femoral Augments																														
Size	Anterior					Posterior (5 mm)					Posterior (10 mm)					Distal (5 mm)					Distal (10 mm)					Distal Only (10 mm)				
	C	D	E	F	G	C	D	E	F	G	C	D	E	F	G	C	D	E	F	G	C	D	E	F	G	C	D	E	F	G
C Left	C					CS					CS					CS					CS					CS				
C Right	C					CS					CS					CS					CS					CS				
D Left		C				CS					CS					CS					CS					CS				
D Right		C				CS					CS					CS					CS					CS				
E Left			C				CS					CS					CS					CS					CS			
E Right			C				CS					CS					CS					CS					CS			
F Left				C				CS					CS					CS					CS					CS		
F Right				C				CS					CS					CS					CS					CS		
G Left					C				CS					CS					CS					CS					CS	
G Right					C				CS					CS					CS					CS					CS	

CS: Cement or Screw Attachment
 C: Cement Attachment Only

NexGen Finned Precoat Femoral Augments (Continued)

Size	Distal Only (15 mm)					Distal Only (20 mm)					Posterior Only		
	C	D	E	F	G	C	D	E	F	G	E	F	G
C Left	C					CS							
C Right	C					CS							
D Left		C				CS							
D Right		C				CS							
E Left			C				CS				CS		
E Right			C				CS				CS		
F Left				C				CS				CS	
F Right				C				CS				CS	
G Left					C				CS				CS
G Right					C				CS				CS

CS: Cement or Screw Attachment
 C: Cement Attachment Only

All content herein is protected by copyright, trademarks and other intellectual property rights, as applicable, owned by or licensed to Zimmer Biomet or its affiliates unless otherwise indicated, and must not be redistributed, duplicated or disclosed, in whole or in part, without the express written consent of Zimmer Biomet.

This material is intended for health care professionals and the Zimmer Biomet sales force. Distribution to any other recipient is prohibited.

Zimmer Biomet does not practice medicine. This technique was developed in conjunction with health care professionals. This document is intended for surgeons and is not intended for laypersons.

Each surgeon should exercise his or her own independent judgment in the diagnosis and treatment of an individual patient, and this information does not purport to replace the comprehensive training surgeons have received. As with all surgical procedures, the technique used in each case will depend on the surgeon's medical judgment as the best treatment for each patient. Results will vary based on health, weight, activity and other variables. Not all patients are candidates for this product and/or procedure.

For product information, including indications, contraindications, warnings, precautions, potential adverse effects and patient counseling information, see the package insert and www.zimmerbiomet.com.

Caution: Federal (USA) law restricts this device to sale by or on the order of a surgeon. Rx only.

Check for country product clearances and reference product specific instructions for use.

Not for distribution in France.

© 2017 Zimmer Biomet



 **Legal Manufacturer**
Zimmer, Inc.
1800 West Center Street
Warsaw, Indiana 46580
USA

zimmerbiomet.com

CE 0086

CE mark on a surgical technique is not valid unless there is a CE mark on the product label.