

Revision NexGen[®] LCCK Instrumentation

for Legacy[®] Constrained Condylar Knee

Surgical Technique



ZIMMER BIOMET
Your progress. Our promise.[®]

Table of Contents

Revision NexGen LCCK Surgical Technique Options Chart	2
Introduction	3
Revision Arthroplasty	3
Revision Instrumentation Design Rationale	4
Optional Technique Using the MICRO-MILL® Instrumentation System	4
Implant Design Rationale	4
Preoperative Planning	5
Primary Prosthesis Extraction	5
Step 1. Determine Tibial Prosthetic Platform	6
Step 2. Finish the Tibia	10
Offset Stem Extension	12
Tibial Augmentation	13
Drilling the Stem Base	14
Step 3. Prepare the Femoral Canal	17
Step 4. Evaluate Femoral Size	19
Femoral Sizing Templates	19
Previous Prosthesis	19
Epicondylar Width	19
Step 5. Determining Femoral Rotation	21
Establish Femoral Rotation and Position	
Using the Femoral Stem Base Instruments	23
Determine Component Placement	
Using offset Stem Technique Epicondylar Width	25
Drilling for the Femoral Stem Base	25
Step 6. Establish Flexion Gap and Stability	28
Step 7. Establish Extension Gap and Stability	29
Balance Soft Tissues	30
Joint Line	30
Step 8. Make Femoral Augment Cuts	32
Step 9. Prepare for the LCCK Box	33
Step 10. Prepare the Patella	37
Step 11. Perform Trial Reduction	38
Patellar Tracking	39

Step 12. Component Implantation	40
Component Implantation	40
Femoral Component Preparation	40
Stem Extension.....	40
Attachment of Augments.....	41
Tibial Component Preparation	41
Stem Extension.....	41
Intraoperative Technique	41
Appendix A - Crossover Technique	45
Apply Cutting Block Assembly.....	45
Ream Femoral Canal.....	45
Drill Femoral Canal	46
Insert Provisional Assembly	46
Appendix B - Resecting the Distal Femur	47
Appendix C - Balancing Flexion/Extension Gaps	49
Appendix D - Using MICRO-MILL/(5-in-1) Instrumentation System for a LCCK Primary Procedure	50
Size the Femur.....	50
Prepare the Femoral Canal	52
Set A/P Position of the Femur	53
Secure Femoral Mounting Bases.....	54
Femoral Resection (Milling)	54
Posterior Condyle Resection (Milling)	55
Femoral Resection (5-in-1).....	56
Appendix E - Using MICRO-MILL/(5-in-1) Instrumentation System for a LCCK Revision Procedure	57
Establish Femoral Alignment	57
Set A/P Position of the Femur	57
Secure Femoral Mounting Bases.....	58
Femoral Resection (Milling)	59
Posterior Condyle Resection (Milling)	60
Femoral Resection (5-in-1).....	60
Appendix F - Using MICRO-MILL/(5-in-1) Instrumentation System for a LCCK Knee with an Offset	61
Offset Stem	61
Establish Femoral Alignment with an Offset Stem	61
Set A/P Position of the Femur	63
Secure Femoral Mounting Bases.....	64
Femoral Resection (5-in-1).....	65
Appendix G - Augment Compatibility	66
Tibial Augment Compatibility	66
Femoral Augment Compatibility	68

Revision NexGen LCKK Surgical Technique Options Chart

- 1 Select the type of instrumentation to be used
- 2 Select Offset or Straight Femoral Stem Extension
- 3 Follow Technique Steps in Order

Selected Instruments			
Using Femoral Stem Base Instruments	Using MILL/5-in-1 Instruments	Using MILL/5-in-1 Instruments	Crossover* to Stemmed Femoral From all Other NexGen Primary LCKK Technique
Intended Femoral Stem Extension			
Straight or Offset Stem Extension	Straight Stem Extension	Offset Stem Extension	Straight Stem Extension
Follow LCKK Surgical Technique In this Order			
<ol style="list-style-type: none"> 1. Tibial Cut 2. Finish Tibia 3. Ream Femur Appendix B 4. Femoral Sizing 5. Femoral Rotation 6. Flexion Gap 7. Extension Gap 8. Femoral Augments 9. LCKK Box Cuts 10. Patella Preparation 11. Trial Reduction 	<ol style="list-style-type: none"> 1. Tibial Cut 2. Finish Tibia 3. Ream Femur Appendix B Appendix E 6. Flexion Gap 7. Extension Gap 8. Femoral Augments 9. LCKK Box Cuts 10. Patella Preparation 11. Trial Reduction 12. Comp. Implantation 	<ol style="list-style-type: none"> 1. Tibial Cut 2. Finish Tibia 3. Ream Femur Appendix B Appendix F 6. Flexion Gap 7. Extension Gap 8. Femoral Augments 9. LCKK Box Cuts 10. Patella Preparation 11. Trial Reduction 12. Comp. Implantation 	<ol style="list-style-type: none"> 1. Tibial Cut 2. Finish Tibia Appendix A

* Crossover - the crossover technique can be used after A/P cuts on the femur are completed for a non-stemmed NexGen femoral component. The intent is to create a path for a straight stem extension that is relative to the existing A/P femoral bonecuts.

Introduction

The NexGen Legacy Constrained Condylar Knee (LCCK) components are designed for use in difficult primary surgeries as well as revision surgeries. Although most LCCK surgeries involve revision arthroplasty, this document provides options for both primary and revision techniques.

Critical to achieving a successful revision surgery is the development of efficient and accurate instrumentation combined with effective surgical techniques. The main body of this document explains the use of the NexGen Revision Instruments for an LCCK revision procedure, although the technique can also be used for a primary procedure. This technique is followed by appendices that provide additional information about issues relating to revision knee arthroplasty, and describe some of the many surgical technique and instrumentation options available for both primary and revision LCCK arthroplasty.

Revision Arthroplasty

Revision total knee arthroplasty, in particular, can be a very challenging task for any orthopaedic surgeon. Failure of a primary arthroplasty may have many causes, including wear, aseptic loosening, infection, osteolysis, ligamentous instability, and patellofemoral complications. One of the most important requirements in revision knee surgery is to identify the exact failure mode of the preceding arthroplasty. If this is not clearly understood, the revision is less likely to succeed. A common reason for failure in a revision total knee arthroplasty is to repeat the errors which occurred at the previous TKA.

In approaching revision procedures, the surgeon must consider the planning of the incision over a previously operated site, the condition of the soft tissue, the functionality of the extensor mechanism, the extraction of the primary prosthesis, and the preservation of bone stock. The primary goals of a revision procedure include the restoration of anatomical alignment and functional stability, the fixation of the revision implants, and the accurate reestablishment of the joint line.

When using the NexGen Revision Instruments, the specific objectives of a revision procedure are threefold:

- 1. Establish Tibial Platform:** The first goal is to establish a prosthetic platform on solid existing tibial bone stock. This will provide a reference plane for evaluating the flexion and extension gaps.
- 2. Stabilize Knee in Flexion:** Next, the femoral component size that will stabilize the knee in flexion is chosen and, if needed, augmentation to fit the femoral condylar bone stock is determined.
- 3. Stabilize Knee in Extension:** Next, the knee is stabilized in full extension to achieve collateral ligament symmetry and balance. Finally, flexion and extension gaps are balanced. An acceptable position for the joint line is estimated to optimize patello-femoral tracking. This will aid in the determination of the proper articular surface thickness, distal femoral position (augments may be necessary), and femoral size that will stabilize the knee in extension.

Revision Instrument Design Rationale

The NexGen Revision Instruments are an intramedullary referencing system. All femoral and tibial cuts are based from reamers or stem extension provisionals located within the medullary canal.

In this way, the instruments reference one of the remaining reliable landmarks of the diseased or badly deformed knee—the medullary canal. The instruments also allow the surgeon to confirm alignment using extramedullary checks throughout the procedure.

The femoral provisional/cutting guides serve double duty: as guides to perform the augmentation cuts, as well as provisionals to facilitate trial reductions before and after bone resection.

Optional Technique Using the MICRO-MILL Instrumentation System

The MICRO-MILL Instrumentation System can be used to implant an LCCK Femoral Component in either a primary or revision surgery. If an LCCK Prosthesis is being implanted in a primary case, and the surgeon prefers to use either the milling or 5-in-1 saw blade options available with the MICRO-MILL Instrumentation System, begin with APPENDIX D to prepare the femur first. If the surgeon prefers to prepare the tibia first, complete STEPS ONE-TWO of the LCCK technique. Then proceed to APPENDIX D. If an LCCK Prosthesis is being implanted in a revision case, begin with STEPS ONE-FOUR of the LCCK technique. Then proceed to APPENDIX E.

Implant Design Rationale

The NexGen Legacy LCCK Femoral Component is intended for use with the LCCK Articular Surface in patients who, in the surgeon's judgement, require additional prosthetic stabilization due to inadequate mediolateral, anteroposterior, and varus/valgus ligament function. The LCCK Femoral Component can also be used in conjunction with the NexGen Legacy LPS Articular Surface in cases where the use of a femoral augment or stem extension is needed due to poor or absent femoral bone stock, but adequate collateral ligament stability is present. When the LCCK Femoral Component is used with an LPS Articular Surface, no varus/valgus constraint is provided.

The LCCK Components feature a close fit between the elevated tibial spine and the intercondylar box, partially restricting varus/valgus and rotational component movement. This close fit is designed to provide stability for patients who lack functional collateral ligaments or whose knees cannot be stabilized by the usual soft tissue releases.

To further accommodate the specific needs of each patient, four tibial base plate styles are available for use with the LCCK Femoral Component, (standard precoat stemmed, fluted stemmed, A/P wedge stemmed, and 3° fluted stemmed). The LCCK Components can be used with the standard precoat stemmed, fluted stemmed base plates and the MIS modular tibial plate and Keels when the tibial plateau allows for a posterior cut with a 7° slope. The LCCK Components can also be used with the A/P wedge stemmed tibial base plate when anterior bone stock is compromised and a nonsloped (0°) tibial cut is preferred, or the 3° fluted stemmed tibial base plate when a 3° cut is preferred.

Preoperative Planning

As with all primary and revision arthroplasty, preoperative planning is essential. Estimate the size of the femoral component by templating from a true lateral x-ray of the contralateral knee. Be sure that the LCCK stem extension template is centered within the femoral medullary canal. Intraoperative restoration of the appropriate A/P depth of the femur will yield the most stable flexion gap. Estimate the need for posterior femoral augmentation by overlaying the appropriate size femoral template on the lateral x-ray of the failed total knee replacement. Templating the proximal/distal position of the femoral component on an A/P x-ray film is often difficult. Use the inferior pole of the patella to help determine the appropriate position of the joint line.

Templating the tibial component can yield similar information. Determine the level of bone resection and the possible need for augmentation or an offset stem by centering the tibial stem extension within the tibial canal on the A/P x-ray film. Template the tibia from the lateral x-ray to assure that excessive tibial slope does not significantly change the tibial resection level. Use the lateral x-ray to initially choose among the standard or fluted stemmed, A/P wedge stemmed, and 3° fluted stemmed tibial component design.

The Zimmer Revision Knee Arthroplasty Surgical Guidelines booklet is strongly recommended for a more complete discussion on revision total knee arthroplasty technique.

Primary Prosthesis Extraction

Remove the failed tibial and femoral components, compromising remaining bone as little as possible. Remove all cement and debride all bone surfaces down to good quality bone. Perform a synovectomy when indicated to remove cement or wear debris.

Inspect the patellar component for wear and loosening. If either is present, remove the patellar prosthesis. If the patellar component is not worn and is well fixed, decide whether the design is compatible with the NexGen LCCK Femoral Component. If the design is compatible, it may be more appropriate to leave the previous patellar component and avoid damage to the patellar bone. See the LCCK package insert for contradictions, warnings and precautions.

Step 1

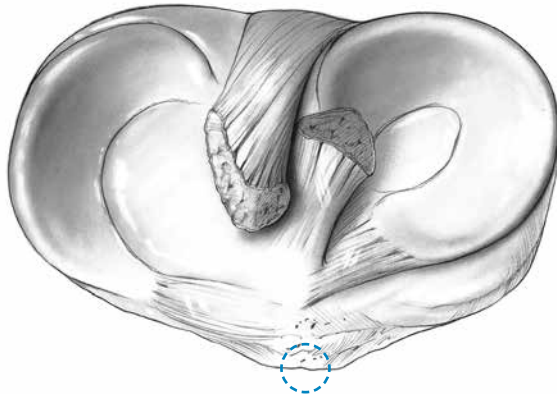


Figure 1

Determine Tibial Prosthetic Platform

After removing the tibial component, remove cement and other debris. If necessary, drill a starting hole. Center the 8 mm IM drill mediolaterally. For primary arthroplasty, locate the hole just anterior to the insertion of the anterior cruciate ligament.

For revision arthroplasty, locate it approximately 15 mm from the anterior cortex. In revision, the location of the medullary canal must be determined from preoperative radiographic planning and confirmed at the time of surgery by the location of the tibial crest (Figure 1). The entry point for the drill should be over the midpoint of the isthmus of the tibial canal, not necessarily the midpoint of the proximal tibia. This is particularly important if an offset stem is anticipated. With the drill properly positioned, drill the hole.



Figure 2

Prepare the tibial canal by using progressively larger intramedullary reamers beginning with the 9 mm diameter reamer. Ream to a depth that allows all the reamer teeth to be buried beneath the surface of the bone. Proceed up to the diameter size that contacts the cortical bone (Figure 2).

The appropriate size of the final reamer should be estimated in preoperative planning and is confirmed when cortical bone contact is made.

Note: The reamers are not end cutting but, instead, have a bullet tip lead that reduces the chance of perforating the cortex of the tibial bone. Insert the first size reamer that engages cortical bone deeper than the length of tibial stem to be used. This, in turn, will allow adequate room for the next larger diameter reamers to be inserted to the final depth without the bullet tip stopping progression of the reamer.

Step 1 (cont)

Figure 3

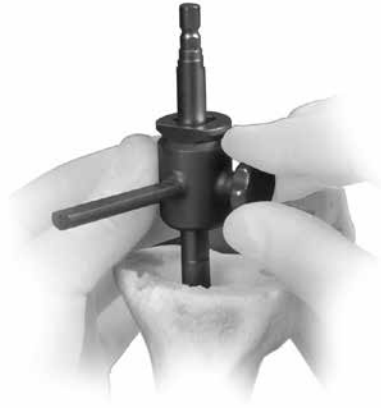


Figure 4



Figure 5

Determine Tibial Prosthetic Platform (cont.)

Be sure that the reamer remains in line with the tibial shaft based on external tibial landmarks. Retained cement and/or sclerotic bone in this area will tend to deflect passage of the reamer. If this happens, remove the cement or sclerotic bone. Leave the final intramedullary reamer in place, or remove the reamer and attach the straight stem extension provisional that corresponds to the last reamer size used to the stem provisional adapter (Figure 3). Insert the stem extension provisional and stem provisional adapter into the reamed canal.

Note: A shorter, possibly larger diameter, stem may be desired. Preparation for this stem is accomplished after the tibia is cut by further reaming to the shorter depth with the required diameter reamers.

Attach the appropriate tibial boom to the reamer shaft (Figure 4) or the stem extension provisional assembly. There are three tibial boom options: 0°, 3°, and 7° posterior slope configurations. Use the 0° boom when the A/P wedge stemmed tibial base plate requiring a non-sloped (0°) tibial cut is used. Use the 3° boom when the 3° fluted stemmed tibial base plate is used. Use the 7° boom when the precoat stemmed tibial base plate, the fluted stemmed tibial base plate or the MIS modular tibial plate and keels is used. Be sure to direct the boom anteriorly over the medial half of the tibial tubercle.

The standard cutting slot on any of the augmented tibial cutting guides can be used for a flat cut. Slide the selected tibial cutting guide onto the tibial boom until it contacts the anterior tibia. Then tighten the thumb screw (Figure 5).

Step 1 (cont)

Figure 6

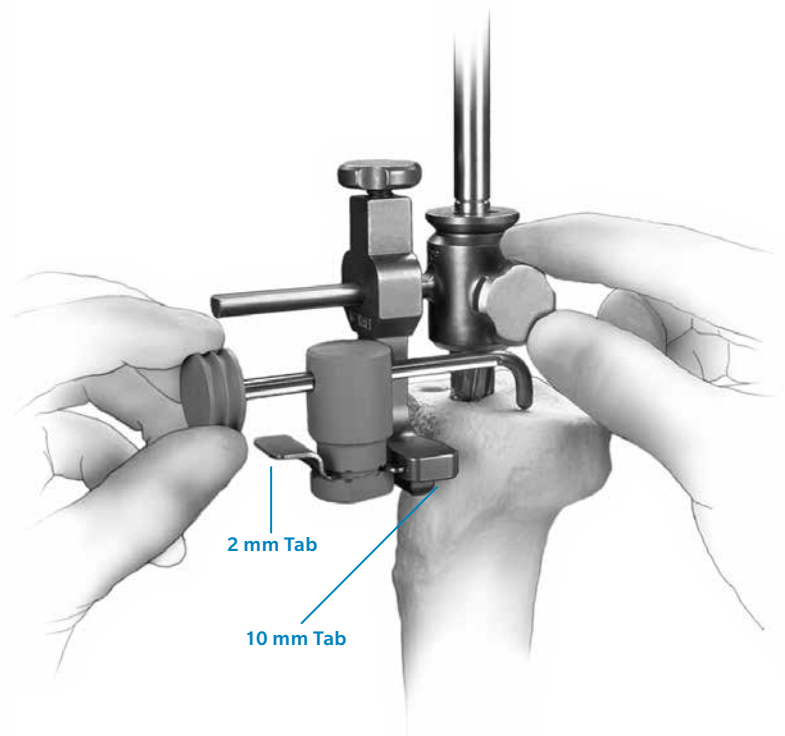


Figure 7

Determine Tibial Prosthetic Platform (cont.)

The rotation of the tibial cutting guide is important. Orient the cutting guide so it cuts directly from the front to the back of the tibia. Varus/valgus orientation is equally important. Check this by attaching the extramedullary alignment arch to the tibial boom and tightening the thumb screw. Then insert the alignment rod through the arch (Figure 6).

Palpate the malleoli and note the midpoint. The cutting guide should be positioned so the alignment rod follows the anterior tibial crest and points about 7–10 mm medial to the midpoint between the malleoli. The tibialis anterior tendon can also be used to check the varus/valgus position of the cutting guide. The distal end of the alignment rod should be in line with the tendon. This will help confirm that the resected surface will be 90° to the mechanical axis.

After proper rotation and varus/valgus orientation has been achieved, determine the appropriate depth of resection by taking into consideration the depth of any defects that are present.

This should be a minimal resection. The purpose of this cut is to create a flat surface only. Use the tibial depth resection gauge to define where the saw cut will be made. Insert the 2 mm or 10 mm tab of the gauge into the cutting slot (Figure 7) depending on which resection level has been selected. Alternatively, use the resection guide to check the resection level. Minimal bone removal is recommended. It is not necessary to resect below all defects. Relatively small defects can be grafted and others filled with cement or augments. When the appropriate depth has been determined, tighten the thumb screw on the boom.

Note: When the A/P wedge or 3° fluted tibial component has been chosen, the measurement for depth of resection should be taken as far posterior on the tibia as possible. This should be performed to help reestablish the joint line because the posterior slope is built into the implant and not cut into the bone.

Step 1 (cont)



Figure 8

Determine Tibial Prosthetic Platform (cont.)

Pin the tibial cutting guide to the tibia securely with two headless holding pins.

Use an oscillating saw with a 0.050 inch/1.27 mm blade to cut through the slots (Figure 8). Initiate the resection with the reamer or stem extension provisional assembly in place. Be sure that the tibial cutting guide is securely attached to the reamer or stem extension provisional assembly during the initial cutting process. This adds further stability to the cutter.

After cutting the medial and lateral plateaus, remove the tibial boom and reamer or provisional assembly leaving the tibial cutting guide in place, then finish the cut.

Remove the tibial cutting guide.

Step 2



Figure 9

Finish the Tibia

Select the stemmed tibial sizing plate that provides the desired tibial coverage by placing various size plates onto the resected tibial surface. Be sure to select the appropriate style sizing plate (standard, fluted, A/P wedge, or 3° fluted) which corresponds to the boom selected in the previous step. Attach the tibial provisional/drill guide holding clamp to the selected sizing plate (Figure 8). Then use the alignment rod to aid in confirming varus/valgus alignment.

Note: The color code designation on the stemmed tibial sizing plate should be compared to the color code designations on the anterior flange of the selected femoral provisional. At least one of the colors listed on the femoral provisional must match at least one color on the sizing plate to ensure that the components, in combination with the articular surface, will be kinematically matched.

The colors must match exactly. For example, Yellow = Yellow. The striped colors are not the same as the standard colors (Yellow ≠ Striped Yellow) and should not be viewed as a match. If there is no match between the femoral provisional and sizing plate, adjust the size of the femoral provisional or the sizing plate being used to yield a match.

Reinsert the last Intramedullary reamer or the stem extension provisional assembly. Place the sizing plate over the reamer shaft or stem extension provisional assembly and onto the prepared bone.

Step 2 (cont)

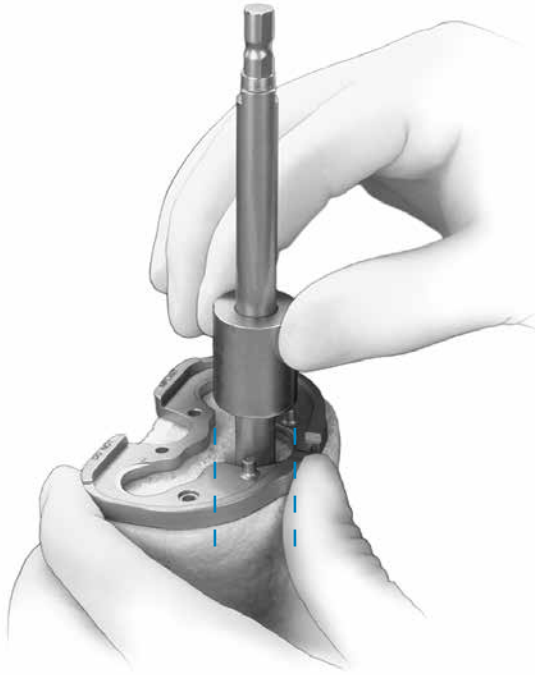


Figure 10

Finish the Tibia (cont.)

Slide the straight bushing over the reamer shaft or stem provisional adapter until it seats into the circular step of the sizing plate (Figure 9). This will properly position the sizing plate relative to the tibial stem location. If the bushing will not seat in the sizing plate, check to be sure that the reamer or provisional assembly is fully inserted into the canal. Also confirm that the correct style of tibial sizing plate is being used (standard, fluted, MIS modular plate and keels, A/P wedge, or 3° fluted). If the straight bushing allows for optimal sizing plate positioning, pin the plate with two short-head holding pins. Remove the bushing, and the reamer or stem extension provisional assembly, leaving the sizing plate.

Note: The sizing plate must be removed prior to the reamer or stem extension provisional assembly if their diameter exceeds 19 mm. Mark the position of the sizing plate using the pin holes or mark with methylene blue prior to removal.

If the position of the sizing plate is not optimal, continue with the “Offset Stem Extension” procedure on page 12. If the position is satisfactory, and tibial augmentation is necessary, proceed to the “Tibial Augmentation” procedure on page 13. If the position is satisfactory, and tibial augmentation is not necessary, proceed to “Drilling the Stem Base” on page 14.

Step 2 (cont)

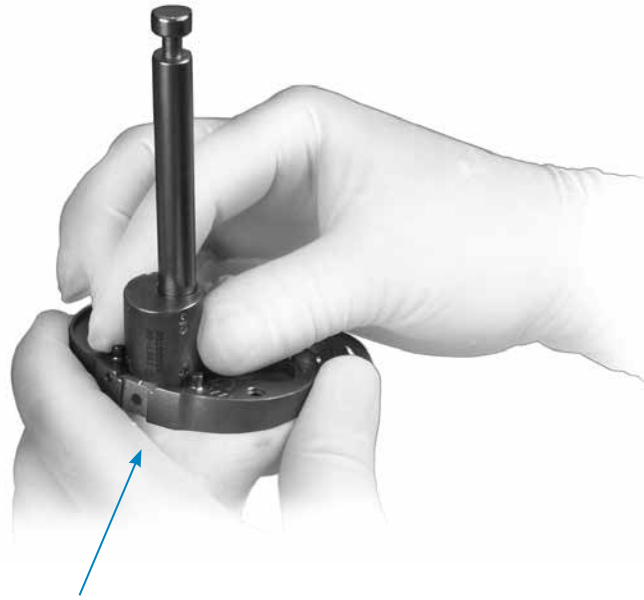


Figure 11

Offset Stem Extension

The NexGen Offset Stem Extension allows the stem on the tibial base plate to be positioned 4.5 mm away from the center of the canal in any direction, a full 360°. This allows the position of the tibial plate to be changed relative to the stem extension and canal in order to optimize coverage of the proximal tibia. If the position of the sizing plate is not optimal, remove the straight bushing and slide the offset bushing over the reamer shaft or stem provisional adapter until it seats into the circular step of the sizing plate. This will allow the plate to be shifted 4.5 mm in any direction. When optimal coverage is achieved, note the position of the etched marks on the bushing relative to the etched mark on the center of the anterior portion of the sizing plate (Figure 11).

Pin the sizing plate with two short-head holding pins. If a tibial augment will be used, do not pin the plate on the side that requires the augment.

If tibial augmentation is not necessary, remove the bushing and the reamer or stem extension provisional assembly, leaving only the sizing plate.

ⓘ **Note:** The sizing plate must be removed prior to the reamer or stem extension provisional assembly if their diameter exceeds 14 mm. Mark the position of the sizing plate using the pin holes or mark with methylene blue prior to removal.

If tibial augmentation is necessary, continue with the “Tibial Augmentation” procedure. If tibial augmentation is not necessary, proceed to “Drilling the Stem Base” on page 14.

ⓘ **Note:** Augment options can be found within Appendix G-Augment Compatibility.

Step 2 (cont)

Figure 12



Figure 13



Figure 14

Tibial Augmentation

If tibial augmentation is necessary, slide the appropriate offset revision tibial boom (0°, 3°, or 7°) over the reamer shaft or stem provisional adapter, and the straight or offset bushing (Figure 12).

The two holes on the bottom of the boom will fit over the two pegs on the top of the sizing plate. Tighten the thumb screw on the boom. Attach the appropriate tibial cutting guide, sliding it along the boom until it contacts bone. Then tighten the thumb screw.

Pin the tibial cutting guide to the bone with headless holding pins (Figure 13). Then use an oscillating saw to begin the augmentation cut. Remove the cutting guide, boom, bushing, sizing plate, and reamer or stem extension provisional assembly.

Reinsert the cutting guide over the headless holding pins. If desired, insert hex-head holding pins to increase the stability of the cutting guide. Then finish the cut (Figure 14).

Remove the tibial cutting guide and holding pins from the bone and attach the appropriate provisional augments to the sizing plate. Pin the plate to the bone with two short-head holding pins. Ensure that the sizing plate remains in the proper position when pinning. Note that one of the pins can be inserted through the provisional augment.

Step 2 (cont)

Figure 15a

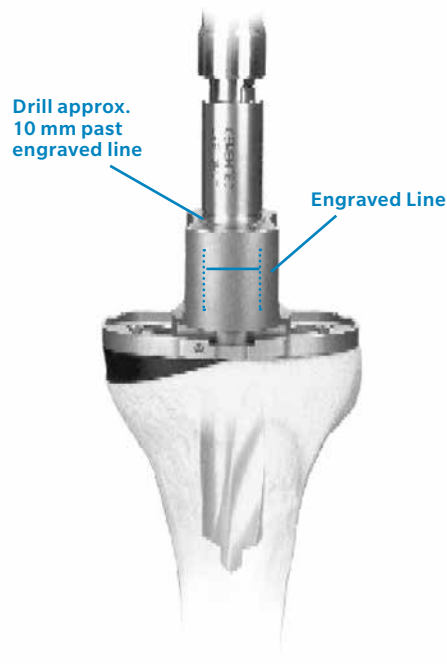


Figure 15b

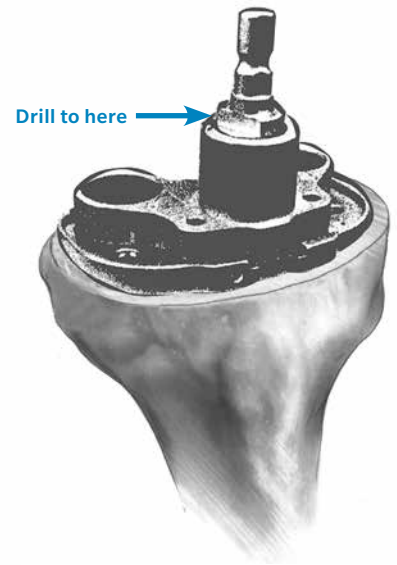


Figure 16

Drilling the Stem Base

Place the cemented stem drill guide on the sizing plate (Figure 15a) and drill approximately 10 mm deeper than the engraved line on the drill (Figure 15b). This step ensures adequate clearance for the transition length of the proximal and distal diameters of the stem extension.

If using a 12.7 mm x 30 mm stem extension, place the porous stem tibial drill guide on the sizing plate and drill for the stem with the porous stem tibia drill. Drill until the top of the drill is flush with the top of the drill guide (Figure 16).

Failure to attain the correct drill depth may cause slight interference fit during implantation. Remove the drill and drill guide. If the tibia has already been reamed to a 17 mm diameter or greater, this drilling step is not required.

Step 2 (cont)

Figure 17

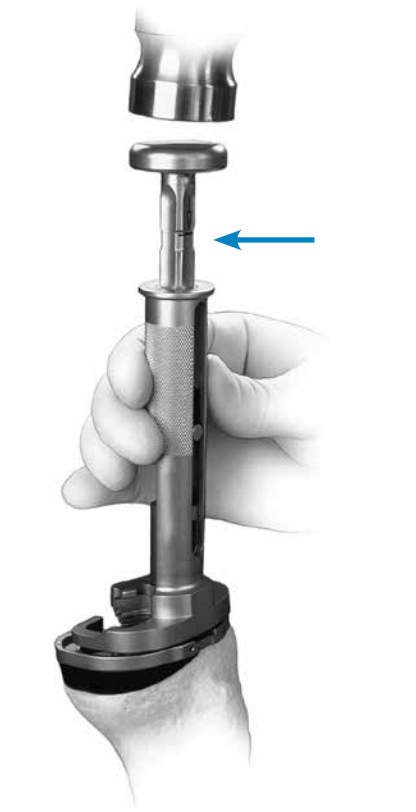


Figure 18

Drilling the Stem Base (cont.)

Attach the proper size and style tibial broach to the broach impactor. The broach can be attached only from the front (Figure 17).

Note: Guide arrows are etched on the broach and impactor for additional guidance.

Seat the impactor over the location pegs on the sizing plate, and impact the broach to the depth indicated by the etched groove on the shaft aligning with the impactor handle (Figure 18). The broach has a built-in stop to prevent over impactation.

Remove the broach impactor assembly and sizing plate.

Step 2 (cont)

Figure 19

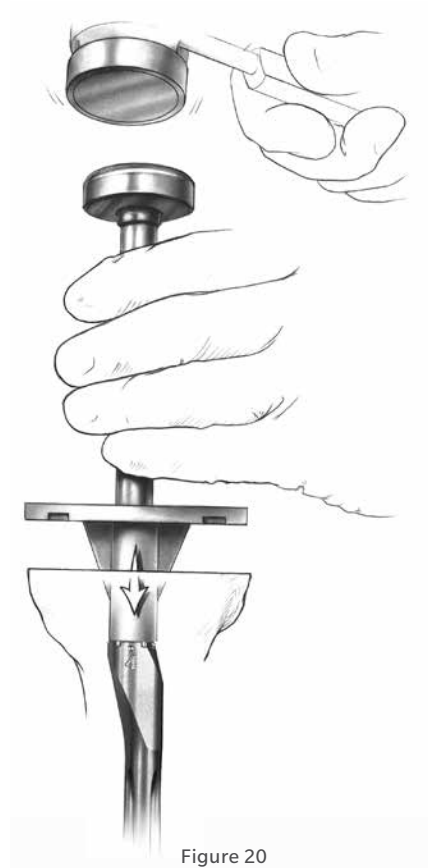


Figure 20

Drilling the Stem Base (cont.)

Assemble the appropriate stemmed tibial provisional, stem extension provisional, and tibial augment provisional for which the bone has been prepared. For a straight stem, use the hex-head screwdriver to fully tighten the stem extension provisional. For an offset stem, line up the appropriate mark on the offset stem extension provisional with the etch mark on the stemmed tibial provisional (Figure 19). This mark should correspond to the mark noted earlier on the offset bushing (See Figure 11, page 12). Attach the stem extension provisional, but do not fully tighten the screw if an offset stem will be used.

Note: The A/P wedge sizing plate can be used as a tibial provisional by attaching the stem base adaptor (00-5987-006-00) to the appropriate sizing plate and attaching the appropriate stem extension to the stem base adaptor.

Insert the final provisional prosthesis assembly into the tibia. For the offset stem, allow the offset stem extension provisional to rotate to attain an optimal position. Be sure that the provisional plate is properly positioned rotationally. Component malrotation on the cut surface of the bone can cause a misfit. Impact the stemmed tibial provisional with the tibial provisional impactor (Figure 20). Check to see that the provisional prosthesis fits the cut surfaces with appropriate apposition to bone. If any undesired gaps are present, remove the provisional component and adjust the bone cuts until a good intimate fit is obtained. Fully tighten the hex screw on the offset stem extension provisional.

Step 3

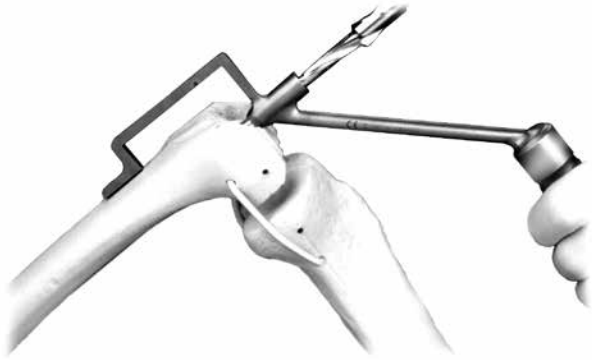


Figure 21



Figure 22

Prepare the Femoral Canal

The optional IM hole locator may be used to find an appropriate entry point for the femoral canal. Place the outrigger of the IM hole locator on the anterior cortex of the distal femur. The outrigger should lie flat on the cortex and parallel to the anatomic axis of the femur. Position the drill guide portion of the hole locator in the center of the patellar sulcus.

This hole location is a starting location for reaming; it is an approximate location for the stem relative to the anterior cortex. With the guide in this position, use the 8 mm drill to make a hole in the medullary canal of the femur (Figure 21). When drilling this hole, be sure to be parallel to the shaft of the femur in both the A/P and lateral projections. After the initial hole is made, remove the IM hole locator and use the step drill to enlarge the entrance hole.

Beginning with the 9 mm intramedullary reamer, progressively ream the femoral canal (Figure 22).

Step 3 (cont)

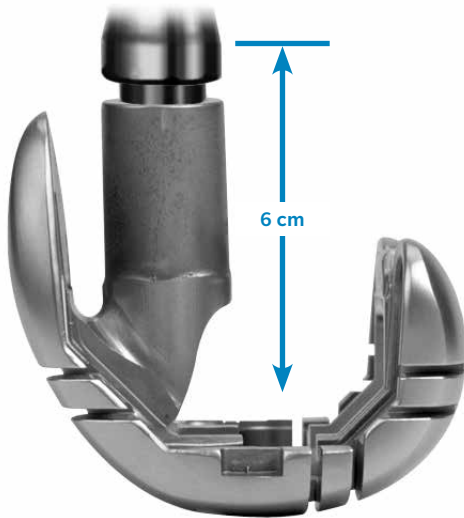


Figure 23



Figure 24

Prepare the Femoral Canal (cont.)

Care should be taken so that the reamer is passed in line with the center of the femoral shaft both in the A/P and M/L planes. Avoid eccentric reaming of the femoral shaft. The appropriate diameter of the final reamer should be estimated in preoperative planning, and is confirmed when cortical bone contact is made. Note the diameter of the last reamer used. To accommodate the stem base of the LCKK Femoral Component, the surgeon must ream 18 mm in diameter to the depth of the stem base and stem extension shoulder, which is 6 cm for the LCKK Component (Figure 23).

If cortical bone contact is made before an 18 mm diameter reamer is used, continue reaming to 18 mm to accommodate the femoral provisional/cutting guide stem base. Alternatively, the 18 mm femoral stem drill can be used to complete the canal preparation necessary to accommodate the stem base.

ⓘ **Note:** If desired, the femoral stem base instruments can be used to drill for the stem base (See STEP FIVE - Establish Femoral Rotation and Position Using the Femoral Stem Base Instruments).

To ensure a 6° valgus angle, attach the standard revision cut block to the revision IM guide. Then attach a straight stem extension provisional, which corresponds to the last diameter reamer used, to the guide. Be sure that the revision IM guide is set for “Left” or “Right” depending on the side of the surgery. Insert the revision IM guide into the femoral canal (Figure 24).

If the revision IM guide sits flush on the cut distal femur, 6° of valgus alignment exists between the orientation of the medullary canal and the distal cut. Proceed to STEP FOUR— Evaluate Femoral Size. If not, recutting the distal femur is necessary. Refer to APPENDIX B— Resecting the Distal Femur.

ⓘ **Caution:** It is recommended that you proceed through the steps establishing balanced flexion and extension gaps and assessing the joint line before resecting the distal femur. Distal augmentation may be necessary.

ⓘ **Note:** The MICRO-MILL Instrumentation System can also be used to prepare the femur for an LCKK revision procedure. If this method is preferred, complete Steps Three and Four, then proceed to APPENDIX E—Using MICRO-MILL Instruments for an LCKK Revision.

Step 4



Figure 25

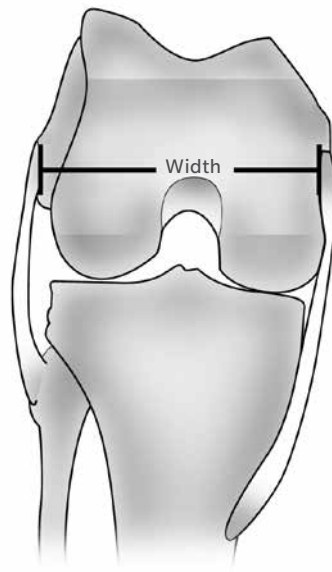


Figure 26

Evaluate Femoral Size

There are several ways to estimate the appropriate femoral size. The following techniques should be used in conjunction with templating as discussed in the Preoperative Planning section, to estimate an approximate femoral size. The final size will ultimately be selected during STEP SIX— Establish Flexion Gap and Stability.

Femoral Sizing Templates

Reinsert the final intramedullary reamer, or attach the stem extension provisional that corresponds to the last reamer size used to the stem provisional adapter. Insert the stem provisional assembly or reamer into the femoral canal. Center the etched line of the various sizes of femoral sizing templates on the shaft of the reamer or adapter until the appropriate size is found (Figure 25).

Previous Prosthesis

Measure the size of the revised previous prosthesis.

Epicondylar Width

The epicondylar width of the femur also aids in selecting the appropriate femoral size. Measure the width of the epicondyles (Figure 26) and use the following chart to assist in defining the appropriate size.

NexGen Femoral Component Size Related to the Transepicondylar Width		
Transepicondylar Width (mm)	Female Size	Male Size
75	C	-
80	D	C
85	E	D
90	F	E
95	G	F
100	H*	G
105	-	H*

*LCKK not available in Size H.

Step 4 (cont)

Evaluate Femoral Size (cont.)

The femoral component must be chosen to stabilize the arthroplasty with the knee in flexion, without regard to the available distal femoral bone. Selecting the femoral component to fit the existing bone may undersize the femoral component and can create a large flexion gap which may be unequal to the extension gap or, if balanced, may lead to undesirable proximal displacement of the joint line.

Note: After estimating the femoral size, one can assemble that size of LCCK femoral provisional/cutting guide with the stem extension provisional that corresponds with the depth of reaming and the diameter of the last reamer used. Seat the femoral assembly on the existing bone. If the components will not seat, use a rongeur to carefully remove any anterior or posterior bone that is preventing insertion or select a larger size of femoral prosthesis. Take care not to over resect at this point.

If using the MICRO-MILL Instrumentation System for an LCCK revision procedure, proceed to APPENDIX E.

Step 5

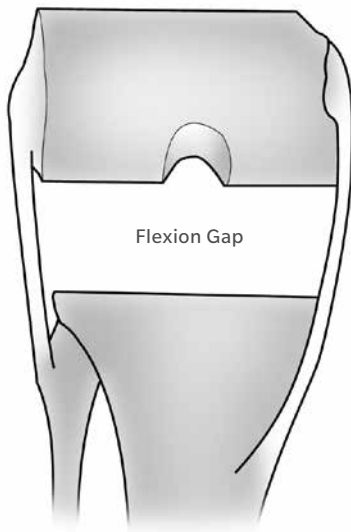


Figure 27

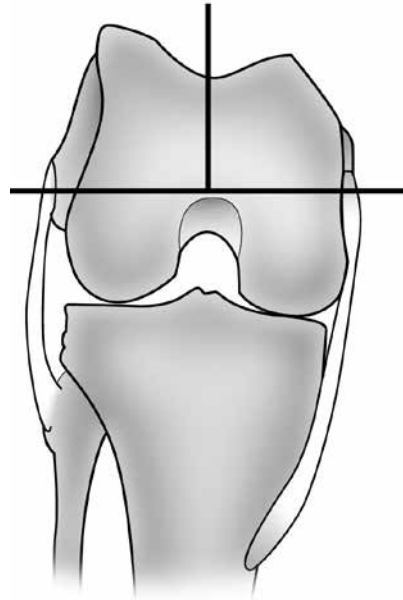


Figure 28

Determining Femoral Rotation

Inappropriate femoral component rotation may create a flexion imbalance and/or compromise patellofemoral kinematics.^{1,2} Therefore, it is important to pay particular attention to femoral rotation.

A number of methods using anatomic landmarks may be used. These landmarks should be combined with appropriate ligament releases to achieve a rectangular flexion gap (Figures 27 and 28). With some of these methods, surgeon judgement must be used as anatomic landmarks are not always reliable because of femoral defects or inconsistencies. When applying judgement, it is particularly important to avoid inappropriate internal rotation.^{1,2}

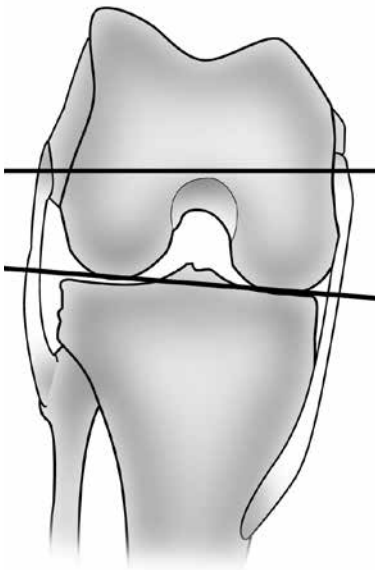
Step 5 (cont)

Figure 29

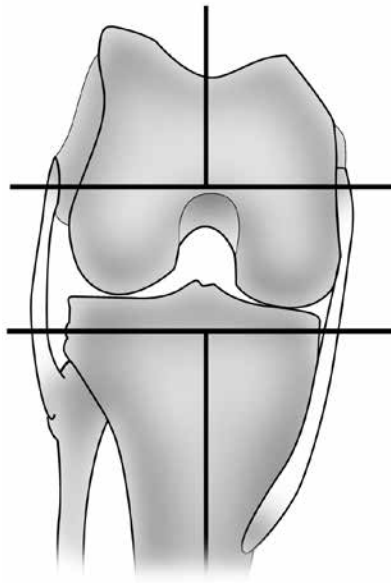


Figure 30

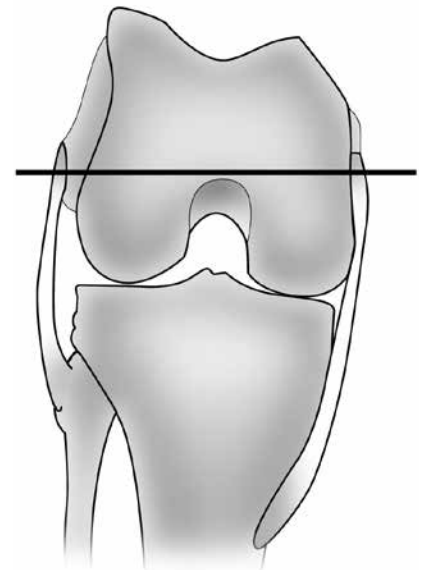


Figure 31

Determining Femoral Rotation (cont.)

One method is to use the posterior femoral condyles (Figure 29); however, erosion of the condyles may distort the reference angle resulting from this method and may result in internal rotation of the femoral component.² The tibial shaft axis may offer assistance as a reference for determining femoral rotation (Figure 30), however, it is usually inadequate and misleading used by itself.

The recommended method for establishing femoral component rotation is to use the epicondyles, the attachment points for the collateral ligaments (Figure 31).² Identifying the epicondylar axis may require additional soft tissue dissection to visualize the epicondyles. The center of the medial epicondyle is located in the sulcus between the proximal and distal origins of the deep MCL. The lateral epicondyle is the most prominent lateral point on the distal femur. The posterior femoral condyles should parallel the transepicondylar axis.^{1,2,3}

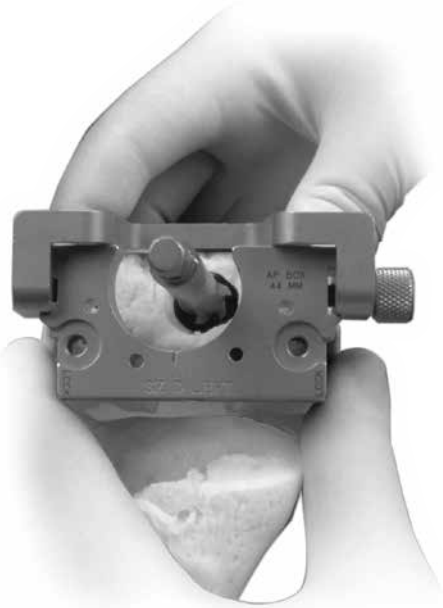
Step 5 (cont)

Figure 32

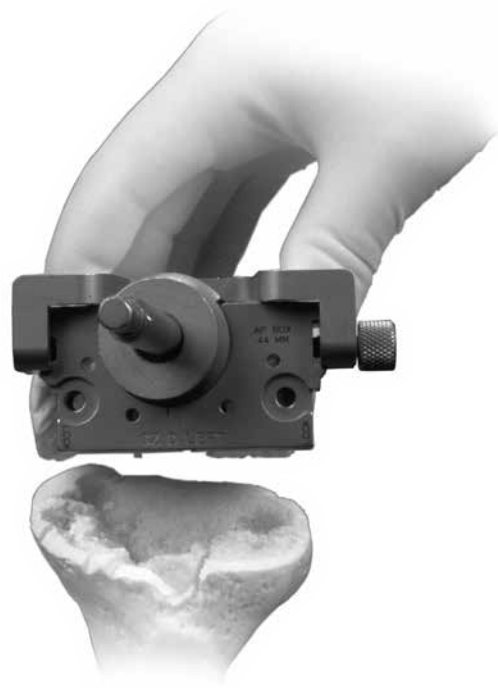


Figure 33

Establish Femoral Rotation and Position Using the Femoral Stem Base Instruments

Attach the femoral base guide flange to the femoral stem base/cutting block that corresponds to the femoral component size chosen.

ⓘ **Note:** In a primary knee procedure, the flange cannot be used since the anterior femoral condyles have not been resected.

Be sure that the proper “Right” or “Left” indication is facing toward you on the cutting block. Tighten the thumb screw to secure the flange to the cutting block. Slide the block and flange over the reamer or stem provisional adapter. The cutting block should be flush against the distal femur and the flange should rest on the anterior femoral cortex (Figure 32).

ⓘ **Note:** Femoral rotation has not yet been set.

Slide the 9–10 mm femoral guide bushing over the reamer shaft or stem provisional adapter until it seats into the circular step of the femoral stem base/cutting block (Figure 33). A collar inside the cutting block serves as a stop to indicate when the bushing is fully seated. The straight bushings have a step that locks them into a keyed rotational orientation on the femoral stem base/cutting block.

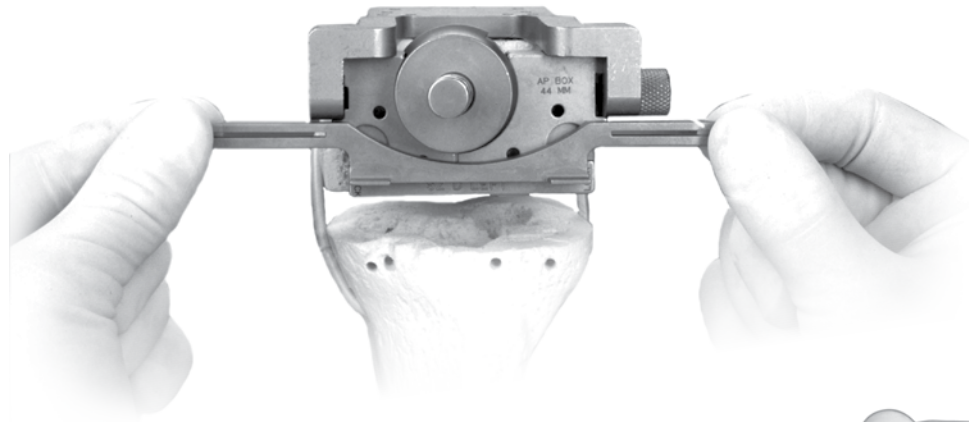
Step 5 (cont)

Figure 34

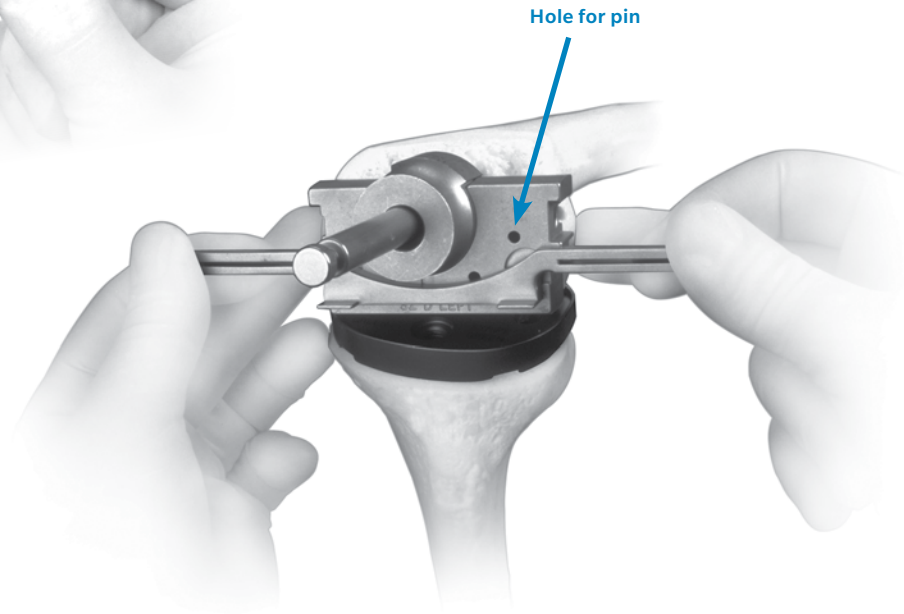


Figure 35

Establish Femoral Rotation and Position Using the Femoral Stem Base Instruments (cont.)

Attach the revision rotational alignment guide to the posterior edge of the femoral stem base/cutting block by inserting the pegs on the alignment guide into the holes on the face of the cutting block. To achieve the proper external rotation of the femoral stem base/cutting block, and the prosthesis, the handles of the alignment guide should be in line with the transepicondylar axis (Figures 31 and 34). If the femoral base guide flange prevents the appropriate rotational adjustment, remove the flange. Then align the handles with the transepicondylar axis^{1, 2} (Figure 35).

If the femoral stem base/cutting block is in proper alignment, and in proper rotation, pin the block in place with two headless holding pins in the upper two holes. Then proceed to page 25 “Drilling for the Femoral Stem Base”.

If the femoral stem base/cutting block indicates a less than optimal position for the femoral component, use of an offset stem extension may be considered. To evaluate use of an offset stem extension, proceed to page 25 “Using Offset Stem Technique”.

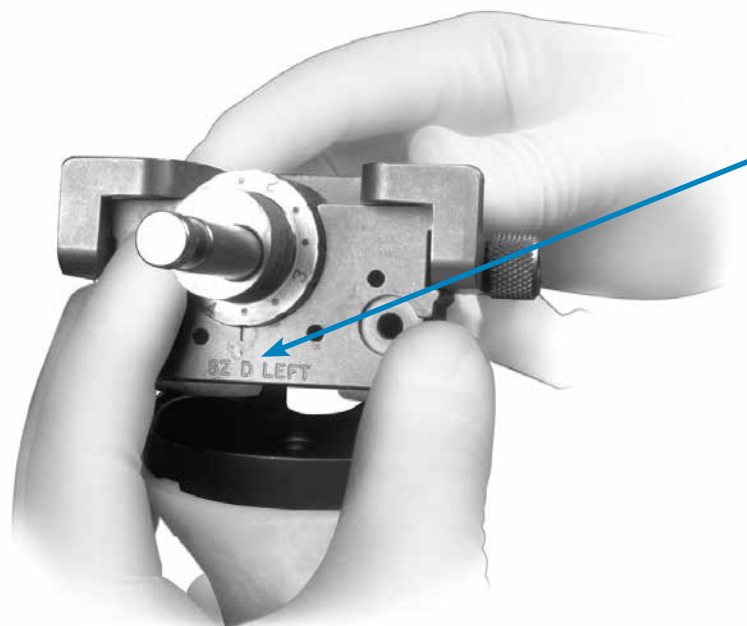
Step 5 (cont)

Figure 36

Establish Femoral Rotation and Position Using the Femoral Stem Base Instruments (cont.)

Determine Component Placement Using Offset Stem Technique

It is important to optimize the A/P and M/L position of the femoral stem base/cutting block on the distal femur. If it appears that the prosthesis will not be properly positioned on the distal femur, an offset stem should be used. (For more information about the offset stem, see APPENDIX F—Femoral Offset Stem Extension Examples on page 61.) To prepare for the offset stem, use the femoral offset bushing in place of the 9–10 mm femoral guide bushing. Insert the femoral offset bushing with the numbers facing out. This bushing does not have a step that locks it into a keyed rotational orientation on the femoral stem base/cutting block. Rotate the bushing within the block until an optimal position is determined.

The femoral offset bushing allows the guide and, therefore, the prosthesis, to be shifted 4.5 mm from the center of the canal in any direction. If the femoral base guide flange prevents appropriate placement, remove the flange.

The necessity for anterior bone resection will result, but be careful not to notch the anterior cortex. Note the orientation of the femoral offset bushing by observing the numbers and marks on the bushing relative to the etched line on the posterior face of the femoral stem base/cutting block (Figure 36). This reference will be needed later in the procedure.

When the position of the femoral stem base/cutting block has been established, confirm appropriate external rotation (For more information, see page 29) and pin the block in place with two headless holding pins in the upper two holes. Remove the 9–10 mm femoral guide bushing or femoral offset bushing. Remove the Intramedullary reamer or, the stem extension provisional assembly with the femoral extractor. Attach the extractor at the slot indicated for the femoral finishing guide.

Drilling for the Femoral Stem Base

Insert the 16–18 mm femoral guide bushing into the cutting block.

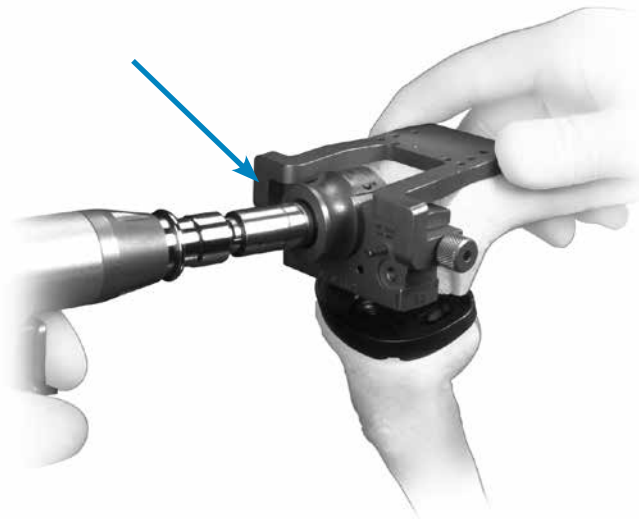
Step 5 (cont)

Figure 37

Establish Femoral Rotation and Position Using the Femoral Stem Base Instruments (cont.)

Drilling for the Femoral Stem Base (cont.)

Attach the femoral stem drill to a drill/reamer and drill through the bushing. Drill to the second engraved line for an LCKK Femoral Component. The depth is indicated on the drill bit (Figure 37).

Remove the femoral base guide flange by loosening the thumb screw if it has not already been removed.

Anterior and posterior clean-up cuts may be necessary due to optimal femoral guide rotation and placement from previous steps (Figures 38 and 38A). For the posterior cut, the posterior saw guide attachment can be assembled to the hole on the posterior edge of the cutting block. The instrument is marked to indicate the side that must face the bone. Assemble the posterior saw guide attachment so that the instrument is flush with the anterior face of the femoral stem base/cutting block. Be sure the thumb screw is fully tightened. Use an oscillating saw to cut the anterior and posterior condyles (Figures 39 and 40). Be sure to guide the anterior and posterior cuts along the angled surface furthest from the bone.

Remove the femoral stem base/cutting block leaving the headless pins in place.



Figure 38



Figure 38A

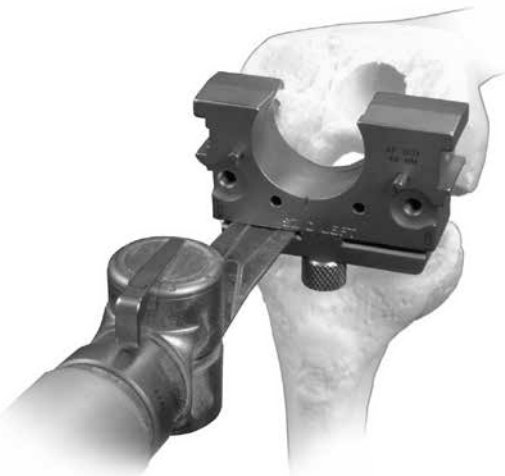


Figure 39



Figure 40

When using a straight stem, insert the appropriate size straight stem extension provisional into the appropriate size femoral provisional/cutting guide.

Step 5 (cont)

Figure 41

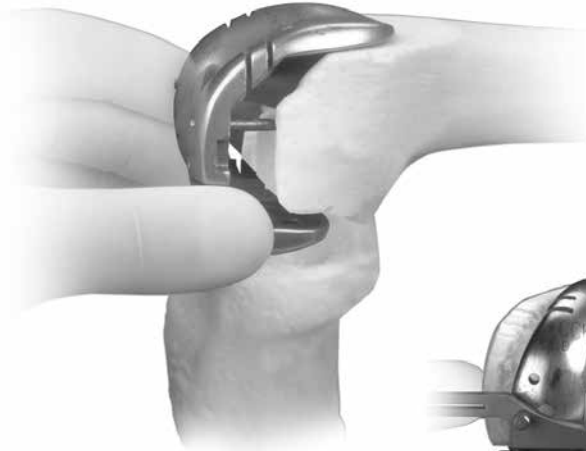


Figure 42

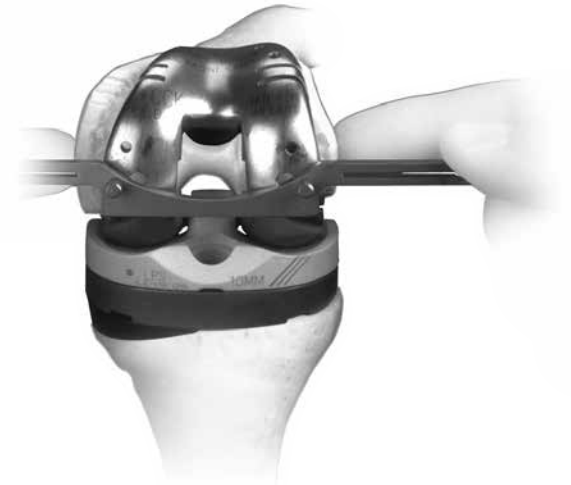


Figure 43

Establish Femoral Rotation and Position Using the Femoral Stem Base Instruments (cont.)

Drilling for the Femoral Stem Base (cont.)

When using an offset stem, fully thread the offset stem locknut onto the appropriate size offset stem extension provisional. Then back thread the locknut until it engages only the first thread. Thread the offset stem extension provisional onto the appropriate size femoral provisional /cutting guide (Figure 41). Rotate the offset stem extension provisional to the position noted earlier on the offset bushing (See Figure 36, page 25). The posterior mark on the stem base of the femoral provisional should be lined up with the appropriate mark on the femoral offset stem extension provisional. Use the offset stem wrench to tighten the locknut against the femoral provisional stem.

With the knee in flexion, insert the provisional/cutting guide assembly onto the distal femur. The cutting guide will fit over the headless pins that are confirming femoral rotation (Figure 42). Seat the femoral assembly on the existing bone. If the components will not seat, use a rongeur to carefully remove any anterior or posterior bone that is preventing insertion. Be careful not to over resect at this point.

Insert the tabs of the revision rotational alignment guide into the posterior augment resection slots of the femoral provisional (Figure 43). The handles of the alignment guide should line up with the transepicondylar axis (For more information, see Figure 31, page 22).

Note: Posterior augment provisionals, most often posterior-lateral, may be inserted into the femoral provisional to provide added stability when correcting external rotation.

The guide may also be used to reference the tibial plateau to confirm a symmetrical gap in flexion.

Remove the revision rotational alignment guide, leaving the cutting guide assembly on the femur.

If additional adjustments to the amount of external rotation are necessary, return to the beginning of this section.

Step 6



Figure 44

Establish Flexion Gap and Stability

Determine the ability of the selected femoral provisional/cutting guide to fill the flexion gap and create stability in flexion.

Begin by inserting the thinnest LPS Articular Surface Provisional of the color indicated on the tibial plate and femoral provisionals (the LCCK Articular Surface Provisional cannot be used because the intercondylar box cut has not yet been made). Evaluate the stability in flexion (Figure 44).

If the thinnest articular surface cannot be inserted, one of two solutions should be explored. First, the femoral provisional can be downsized. Each femoral component size is 4 mm different in the A/P dimension. The selection of the next smallest component will result in an additional 4 mm in flexion space. If this does not allow the thinnest articular surface provisional to be inserted, then the tibial plateau/joint line will have to be lowered. Use the 2 mm tibial recutter to obtain an additional 2 mm in both flexion and extension spaces. If the tibia has additional bone resected then it will be necessary to follow this by repeating STEP TWO—Finish the Tibia.

If the thinnest articular surface provisional does not tense the flexion gap adequately, insert progressively thicker articular surface provisionals until adequate stability is obtained. If the knee is still loose in flexion after trialing the thickest articular surface, consider one of the following options: Augment the tibial component, adding 5 mm or 10 mm blocks to the medial and lateral sides, or select the next larger femoral component. There may be minor asymmetry between the medial and lateral sides. This asymmetry will be addressed in STEP SEVEN—Establish Extension Gap and Stability.

Make an early assessment of the need for posterior augmentation through the posterior augment cutting slots in the cutting guide. If a gap larger than 10 mm exists, consider choosing the next smaller femoral component.

Note: The posterior augment provisionals may be inserted into the femoral provisional to stabilize the prosthesis on the bone.

Step 7



Figure 45

Establish Extension Gap and Stability

After achieving appropriate stability in flexion, leave the final LPS Articular Surface Provisional in place and bring the knee to full extension. Assess the overall limb alignment, symmetry of medial and lateral collateral ligament tension, and overall tension or laxity in full extension, avoid hyperextension. If hyperextension exists, move the femoral trial more distally. Evaluate the resultant space between the femoral component and distal femur. Bring the femoral provisional/cutting guide out to meet the tibial articular surface provisional and create stability in extension.

Note: The distal augment provisionals may be used as spacers to create added stability in extension (Figure 45).

If the gap exceeds the maximum augment available, 10 mm, then evaluate the next smaller femoral component size. This will allow the use of a thicker articular surface and will necessitate a return to STEP

SIX—Establish Flexion Gap and Stability, to reassess the flexion gap.

If full extension is not possible, either move the femoral provisional more proximally or use a thinner tibial articular surface provisional. Another option is to perform a posterior capsule release.

If a thinner tibial articular surface is used, it may be necessary to use the next larger femoral size and return to STEP SIX—Establish Flexion Gap and Stability.

Step 7 (cont)

Figure 46

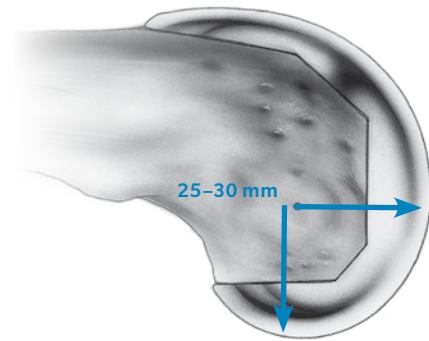


Figure 47

Establish Extension Gap and Stability (cont.)**Balance Soft Tissues**

While the knee is in extension, perform necessary ligament releases to achieve symmetric and adequate tension. In rare cases, ligament advances may be appropriate. Ligament releases should be performed in a manner which is conceptually similar to that in primary arthroplasty. Selectively release the ligaments on the concave or contracted side of the knee until symmetric ligament balance or tension is observed on the medial and lateral sides of the knee with the limb in neutral mechanical alignment. In revision surgery, however, the specific ligamentous structures which may be identified in the primary total knee are likely to be scarred fibrous tissue sleeves that are more difficult to identify and/or release. In general, they are more amenable to treatment as medial or lateral sleeves of undifferentiated ligamentous tissue.

If the knee is well balanced in extension but has significant imbalance in flexion, there may be a rotational problem with the femoral component. Internal or excessive external rotation of this component may cause substantial lateral or medial laxity in flexion, respectively. If so, evaluate the rotational alignment of the femoral component by returning to STEP FIVE—Establish Femoral Rotation.

Joint Line

Assess the joint line. The true joint line in the average knee, in full extension, can be approximated by referencing several landmarks. These landmarks include: one finger breadth distal to the inferior pole of the patella; one finger breadth above the fibular head; and 30 mm distal to the epicondyles.

If desired, use the patella joint line gauge to assess the position of the patella. With the tabs of the gauge positioned in the two slots on the anterior flange of the femoral provisional/cutting guide, the inferior pole of the patellar provisional or unresurfaced patella should fall between the two “Normal” marks on the gauge (Figure 46).

The epicondyles also provide a reference point for distal positioning of the femoral component. The distal joint line averages 25 mm from the lateral epicondyle and 30 mm from the medial epicondyle (Figure 47). This is very similar to the average distance to the posterior joint line and this distance may be used to check femoral component size.

Step 7 (cont)

Figure 48

Establish Extension Gap and Stability (cont.)**Joint Line (cont.)**

If the femoral component rotation is appropriate, the joint line has been reestablished, and the articular surface provisional height is appropriate, the knee should be stable in both flexion and extension. If it is not stable, there is a mismatch between the extension and flexion gaps. Understanding how the size and position of the components affect the flexion and extension gaps is essential to problem solving in total knee arthroplasty. These principles are thoroughly reviewed in APPENDIX C- Balancing Flexion/Extension Gaps.

When the extension gap has been balanced with the previously determined flexion gap, and the limb alignment and joint line have been judged to be accurate, the femoral provisional/cutting guide can be pinned anteriorly using the short-head holding pins to stabilize the guide for the next step (Figure 48). Headless holding pins must be inserted in the holes on the distal condyles to mark external rotation of the femoral provisional/cut guide and to locate subsequent instruments.

Step 8



Figure 49



Figure 50

Make Femoral Augment Cuts

Insert the posterior femoral retractor to protect the posterior capsule, and tibial bone or provisional. Make any necessary posterior or distal augment cuts through the cutting slots in the femoral provisional/cutting guide (Figures 49 and 50). Use a 0.050-inch/1.27 mm thick reciprocating saw blade. A 0.050-inch/1.27 mm thick oscillating blade may also be used. Begin the cuts with the cutting guide in place, then remove the guide, the short-head holding pins, and the headless holding pins to complete the cuts. Once the augment cuts have been made, remove the retractor.

- ⓘ **Note:** It may be necessary to remove the femoral provisional/cutting guide to complete any distal augment cuts. When removing the femoral augment provisionals from any instrument, use the ball-nose screwdriver to push the peg of the augment from the opposite side.
- ⓘ **Note:** Augment options can be found within Appendix G – Augment Compatibility.

Step 9



Figure 51



Figure 52

Prepare for the LCCK Box

Reinsert one or two of the headless holding pins if they were previously removed. These pins will serve to provide rotational alignment for the LCCK Notch/Chamfer Guide.

Note: One headless pin will also provide sufficient rotational alignment along with the central stem base and stem extension.

Remove the stem extension provisional from the femoral provisional/cutting guide and insert it into the stem extension bushing (Figure 51).

When using an offset stem, fully thread the offset stem locknut onto the appropriate size offset stem extension provisional. Then back thread the locknut until it engages only the first thread. Thread the offset provisional onto the stem extension bushing and rotate the offset stem extension provisional so that the appropriate number, noted earlier on the offset bushing (See Figure 36, page 25 and Figure 41, page 27), is lined up with the mark on the bushing.

Use the offset stem wrench to tighten the locknut against the stem extension bushing.

Attach any necessary distal augment provisionals to the LCCK Notch/Chamfer Guide (Figure 52). These provisionals should correspond to the augment cuts that were made in STEP EIGHT – Make Femoral Augment Cuts.

Step 9 (cont)

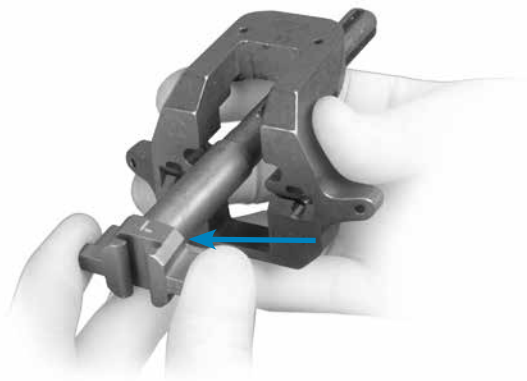


Figure 53



Figure 54

Prepare for the LCCK Box (cont.)

Insert the stem/bushing combination into the LCCK Notch/Chamfer Guide (Figure 53). The bushing is etched with “R” and “L” for right and left knees. Ensure that the proper “R” or “L” designation is showing anteriorly.

Insert the entire notch guide assembly into the femoral canal and onto the headless pins (Figure 54). Be sure that the headless holding pins protrude beyond the face of the guide so they can be grasped with a pin puller for extraction.

ⓘ **Note:** The A/P position of the LCCK Notch/Chamfer Guide is determined by the orientation of the medullary canal. Therefore, the anterior flange of the guide is **not designed to sit flush** with the cut surface of the anterior femoral bone.

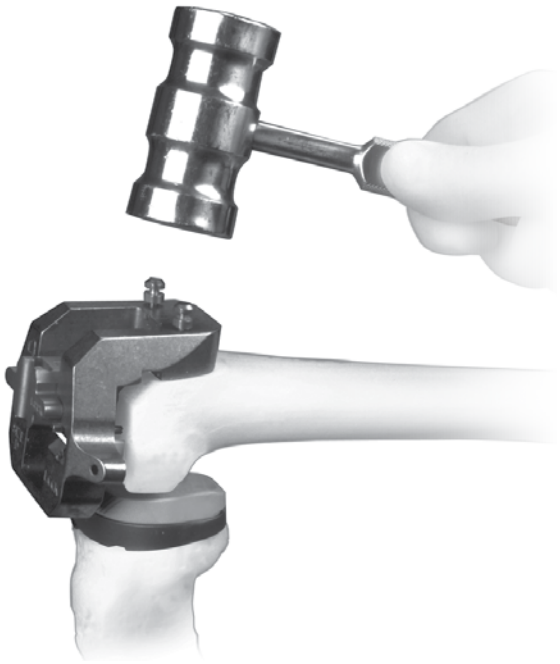
Step 9 (cont)

Figure 55



Figure 56

Prepare for the LCCK Box (cont.)

Insert hex-head holding pins through the anterior or distal tab holes in the guide (Figure 55).

Once the notch guide is secured, remove the stem extension bushing and the stem extension provisional by pulling the assembly out of the guide. The femoral extractor may be used.

ⓘ **Note:** If a straight stem extension provisional larger than 22 mm in diameter or an offset stem extension provisional larger than 17 mm in diameter is used, the notch guide will have to be removed in order to pull out the bushing and stem provisional.

Use a reciprocating or narrow oscillating saw blade to cut the sides and base of the LCCK box (Figure 56).

ⓘ **Note:** The base cut will angle proximally as it goes posteriorly. This angled cut accommodates the spine on the LCCK Articular Surface Component.

Step 9 (cont)



Figure 57

Prepare for the LCCK Box (cont.)

Then use an oscillating saw to cut the anterior and posterior chamfers, if necessary. (Figure 57).

ⓘ **Note:** For sizes C and D, if snap-in distal augments have been used, care must be taken to avoid the peg if it enters the slot with the saw blade.

Remove the holding pins and the notch/chamfer guide.

ⓘ **Note:** When removing the femoral augment provisionals from any instrument, use the ball-nose screwdriver to push the peg of the augment from the opposite side.

Step 10

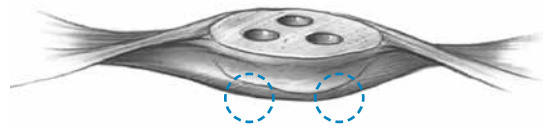


Figure 58



Figure 59



Figure 60

Prepare the Patella

It is not always necessary to revise the patellar component. A well-fixed component from the NexGen System may be left. If the component is loose or found to be incompatible, determine if there is enough bone remaining to implant a new patellar component. Sufficient bone must remain to ensure that the pegs from the new prosthesis do not protrude through the anterior surface (Figure 58).

If the decision is made to replace the primary patellar component with a NexGen Patellar Component, prepare the patellar peg holes by centering the appropriate patellar drill guide over the patella. It may be necessary to rotate the guide to find the best location for fixation. Holding the guide firmly in place, drill the three peg holes using the patellar/femoral drill bit.

The NexGen Patellar Component requires a minimum of 11 mm of remaining bone to allow for the implant pegs. If inadequate bone remains, trim the surface and either leave the residual bone or consider use of a patellar component that has been designed to compensate for defects in the patella (Figure 59).

To compensate for gross bone deficiency, the NexGen Augmentation Patella* provides the additional option of suturing the patella base to the extensor tendon to provide adjunctive fixation (Figure 60). Refer to the NexGen Augmentation Patella Surgical Technique for additional information.

* Indicated for use with bone cement in the USA.

Step 11

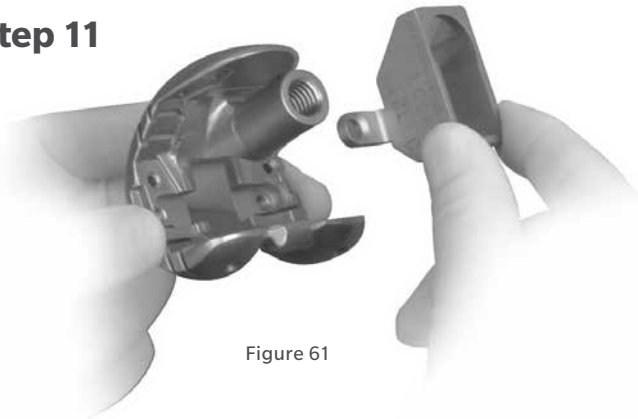


Figure 61



Figure 63



Figure 62

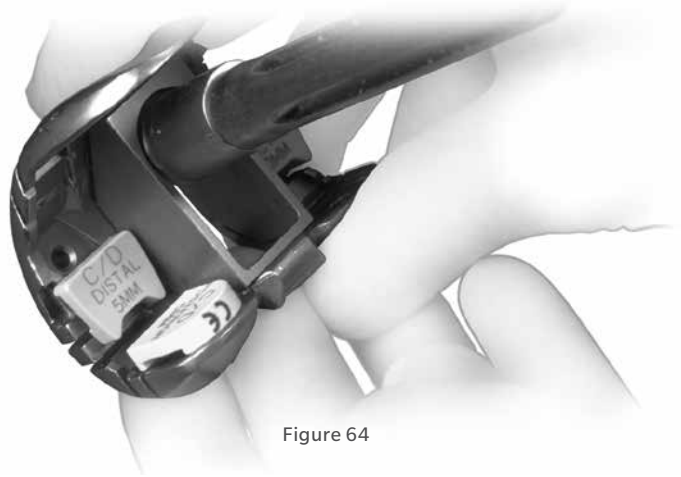


Figure 64

Perform Trial Reduction

Slide the appropriate size modular box provisional onto the LCKK Femoral Provisional/Cutting Guide (Figure 61).

Attach the appropriate posterior augment provisionals, then the distal augment provisionals (Figure 62). The augment provisionals simply snap into place. They will help secure the modular box provisional to the femoral provisional.

If distal femoral augmentation is not necessary, use a femoral augment provisional screw to secure the box (Figure 63).

Note: The modular box provisional is angled to match the bone cut. The provisional box does not match the femoral implant.

If necessary, use any appropriate anterior augment.

Assemble the stem extension provisional to the femoral provisional/cutting guide (Figure 64). Insert the femoral provisional assembly onto the bone to check for proper fit.

Insert the correct size and style of stemmed tibial provisional with the selected tibial augment provisional and stem extension provisional. Attach the proper height and style of articular surface provisional onto the tibial provisional.

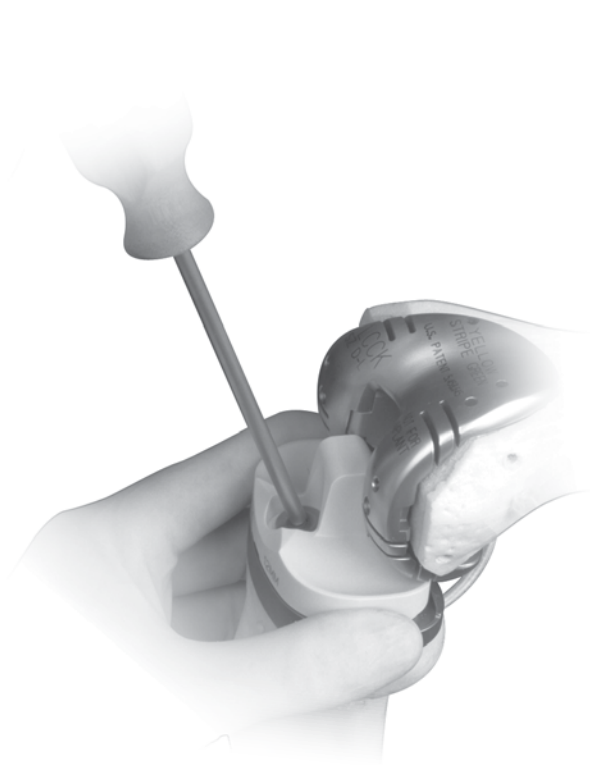
Step 11 (cont)

Figure 65



Figure 66

Perform Trial Reduction (cont.)

When implanting an LCCK Femoral Component, insert the LPS Articular Surface Provisional. If more constraint is needed, remove the LPS Provisional and insert the LCCK Articular Surface Provisional. For either the LPS or LCCK Articular Surface Provisional, insert the locking screw through the articular surface and tighten with the hex-head screwdriver, if desired (Figure 65).

Remember that at least one color and one letter size designation on the tibial provisional must match one of the color and letter designations listed on the femoral provisional, and this color should be the same color of the articular surface family being used. If a three-of-a-kind color/letter match is not obtainable, the incorrect tibial size has been selected and another tray size and articular surface family should be selected.

Insert the patellar provisional. With all provisionals in place, check the range of motion and joint stability (Figure 66).

Perform any necessary soft tissue releases.

Patellar Tracking

Evaluate the tracking of the patellar provisional against the femoral provisional/cutting guide.

The patella must track centrally. Simulate closure of the capsule with either a single suture or by attaching a towel clip. If additional pressure is needed to hold the patella reduced, or if the patella tends to sublux or tilt laterally, perform a lateral retinacular release by a preferred technique. Be careful not to create any defect in the skin. Extend the release until the patella tracks satisfactorily. If a lateral retinacular release fails to correct patellar tracking reassess the rotation of the femoral and tibial components. Also check the orientation of the tibial tubercle. (Refer to steps one, two, and five as necessary).

Remove all provisionals.

Step 12

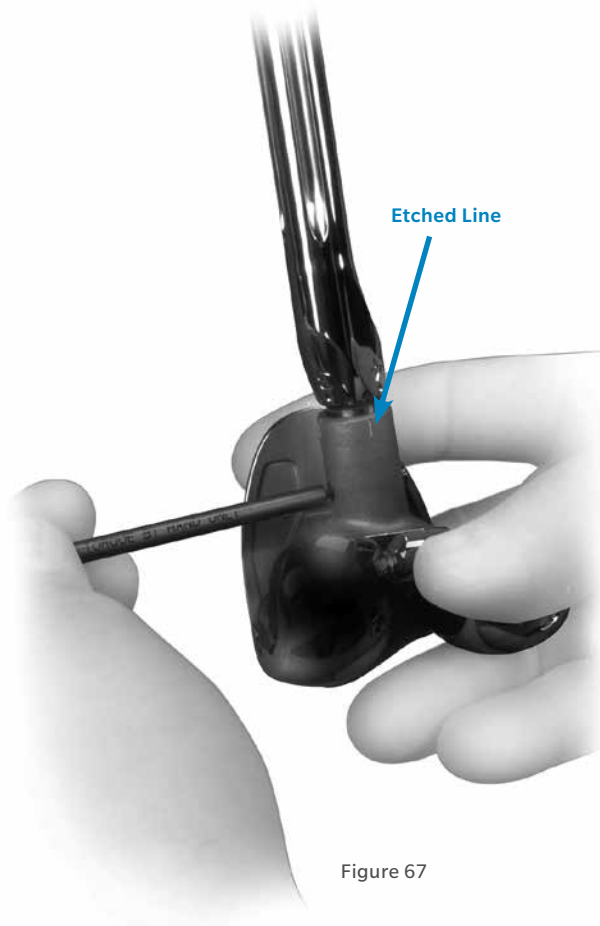


Figure 67

Component Implantation

After the implants have been chosen, make one last check to ensure that the femoral, tibial, and articular surface components match. There are colored squares on each box. There should be a three-of-a-kind color match. If there is, the components are matched.

Femoral Component Preparation

Stem Extension

The locking mechanism between the femoral implant and the stem extension implant is a combination of a Morse-type taper and two set screws. Remove the stem extension locking screw from the stem extension and discard. The stem extension screw is not used with the femoral component.

Check to ensure that the set screws have not migrated or fallen into the femoral stem base taper prior to inserting the stem extension. Insert the stem extension into the base of the femoral component. When using the offset stem extension, use the stem location referenced earlier and line up that stem location number with the etched line on the posterior stem base housing (Figure 67).

The stem extension should be “snug” in the femoral component base.

If toggle exists, back out one or both of the set screws one half turn. When a “snug” fit is achieved, wrap the femoral component in a cloth and place it on a surgical cart. While protecting the stem extension, strike it solidly one time with a two-pound mallet.

Note: Hitting the stem more than once may loosen the taper connection.

After seating the Morse-type taper, tighten the two set screws located in the base of the femoral component. Use the femoral set screw hex driver and apply moderate torque to tighten each of the two set screws (Figure 66).

Note: The femoral set screw hex driver is designed to limit the amount of torque which can be applied to the set screws. Torque by hand only.

It is required that a stem extension always be used with an LCKK Femoral Component.

Step 12 (cont)

Attachment of Augments

The locking mechanism between the femoral implant and the femoral augment implant is a single fixation screw (except the anterior augment which is cemented only). The fixation screw is packaged with the augment.

A special ball-nose style femoral augment screwdriver was designed to attach the posterior lateral augment because the anterior flange prevents straight alignment of the standard hex-head screwdriver. The same ball-nose style screwdriver can be used on all the other femoral augments as well, although the standard hex-head screwdriver may be preferred for attaching the distal femoral augments.

Augments may also be cemented in place and are precoated for enhanced cement fixation. If augments are to be cemented, apply cement between the augment and femoral component, around the sides of each augment, and to the rails of the femoral component. Use the femoral augment holding clamp head with the augment assembly clamp to achieve intimate contact between the augment and the femoral component until the cement is cured.

When using multiple augments, the order in which they are positioned is important. The distal femoral augments must be positioned first, followed by the posterior femoral augments, and then the anterior femoral augment.

⊖ **Note:** Posterior-only and distal-only augments are not to be used in combination with other distal or posterior augments.

Tibial Component Preparation

Tibial augments are designed to be secured to the tibial plate with screws or bone cement. Screws provide automatic alignment on the tibial tray and immediate attachment of the augment. As with the stem extensions, the augment screws are packaged with the augment. If cement is used to attach the augment, use the augment assembly clamp to stabilize the augment while the cement is curing. All augments are PMMA precoated to enhance fixation to the bone cement.

There are two techniques for inserting the tibial articular surface onto the tibial plate. The recommended method is to assemble and tighten the articular surface, tibial plate, and stem extension on the back table. The alternative method is to insert the articular surface intraoperatively, after the tibial plate has been cemented.

If you are using the MIS modular tibial plate and keels, please refer to the Surgical Technique 97-5960-002-00.

Stem Extension

Remove the locking screw from the stem extension implant and discard. The locking screw that will be used is packaged with the LCKK Articular Surface Implant. Insert the stem extension implant into the base of the tibial plate implant. When using an offset stem extension, use the stem location referenced earlier and line up that stem location number with the etched line on the posterior stem base housing. Wrap the tibial component in a cloth and place it on a surgical cart. While protecting the stem extension, strike it solidly one time with a two-pound mallet.

⊖ **Note:** Hitting the stem more than once may loosen the taper connection.

Step 12 (cont)



Figure 68



Figure 69

Tibial Component Preparation (cont.)

By hand, assemble the LCKK Articular Surface onto the implant tray applying downward and posterior force (Figure 68).

Insert the locking screw packaged with the LCKK Articular Surface, and hand tighten with the 4.5 mm hex driver bit (Figure 69). Leave the driver bit set in the screw head.

Step 12 (cont)

Figure 70



Figure 71

Tibial Component Preparation (cont.)

- ⓘ **Note:** The articular surface must be completely seated in the tibial tray prior to torquing the screw. The screw is not intended to pull the articular surface down into the tibial plate.

Select the LCCK Tibial Plate Wrench that has the stem extension diameter that matches that of the implant to be assembled. Insert the stem extension through the stem protector sleeve and into the hole in the wrench that corresponds to the stem extension diameter. Attach the deflection beam torque wrench to the 4.5 mm hex driver bit (Figure 70). Apply 95 in. lbs. of torque with the wrench (Figure 71).

Do not over or under torque. Under-tightening of the screw may allow the screw to loosen over time. Over-tightening may cause the screw to fracture intraoperatively.

Step 12 (cont)



Figure 72



Figure 73

Tibial Component Preparation (cont.)

Intraoperative Technique

Warning: Use of this technique risks disturbing the bone/cement/implant interface.

Remove the locking screw from the stem extension implant and set it on the back table for later use. Insert the stem extension implant into the base of the tibial plate implant. When using an offset stem extension, use the stem location referenced earlier and line up that stem location number with the etched line on the posterior stem base housing. Wrap the tibial component in a cloth and place it on a surgical cart. While protecting the stem extension, strike it solidly one time with a two-pound mallet.

Note: Hitting the stem more than once may loosen the taper connection.

Insert the locking screw packaged with the stem extension and hand tighten with the hex-head screwdriver. This will serve as a temporary screw which will be replaced upon insertion of the LCKK Articular Surface Implant.

Implant the tibial plate and stem extension.

Note: Cement must be cured prior to using this technique. If a leg holder is used, the leg should be removed, and be free to rotate. This will promote proper tibial plate wrench use and help prevent loads from developing at the bone/cement/implant interface.

Remove the temporary locking screw from the stem extension. By hand, assemble the LCKK Articular Surface onto the implant tray applying downward and posterior force. Insert the locking screw packaged with the LCKK Articular Surface and hand tighten it with the 4.5 mm hex driver bit. Leave the driver bit set in the screw head.

Select the LCKK Tibial Plate Wrench that has the tibial plate size that matches that of the implant to be assembled. Place the end of the wrench over the tibial plate. Ensure that the wrench is in line with the base of the tibial plate. Attach the deflection beam torque wrench to the 4.5 mm hex driver bit, (Figure 72). Apply 95 in. lbs. of torque with the wrench (Figure 73). **Do not over or under torque. Under-tightening of the screw may allow the screw to loosen over time. Over-tightening may cause the screw to fracture intraoperatively.**

Appendix A – Crossover Technique



Figure 74



Figure 75

Crossover Technique

During a primary procedure, the surgeon may determine that sufficient bone loss or soft tissue instability is present to warrant a stemmed femoral component. The NexGen Revision Instruments allow the surgeon to convert from NexGen primary implants to a stemmed LCKK Implant intraoperatively. This crossover can be accomplished after the tibial preparation has been completed and all the femoral cuts have been made via any of the NexGen primary techniques.

Apply Cutting Block Assembly

Attach the femoral base guide flange to the appropriate size femoral stem base/cutting block. Be sure that the proper “Right” or “Left” indication is facing up on the cutting block. Tighten the thumb screw to secure the flange to the cutting block. Apply the assembly to the distal femur so the cutting block is flush against the distal femur and the flange rests on the anterior femoral cortex (Figure 74). Position the assembly mediolaterally and insert two headless holding pins into the cutting block, and two hex-head holding pins into the flange.

Ream Femoral Canal

Insert the 9–10 mm femoral guide bushing into the circular step of the femoral stem base/cutting block. The straight bushings have a step that locks them into a keyed rotational orientation on the femoral stem base/cutting block. A collar inside the cutting block serves as a stop to indicate when the bushing is fully seated.

Beginning with the 9–10 mm femoral guide bushing and intramedullary reamer, progressively ream the femoral canal until cortical contact is made or to the stem diameter and depth desired.

Care should be taken so that the reamer is passed in line with the center of the femoral shaft both in the A/P and M/L planes. Avoid eccentric reaming of the femoral shaft.

Note: Care should be taken when reaming to avoid perforating the cortex (Figure 75).

Be sure that the reaming depth is adequate to allow for the length of the stem base on the femoral component plus the length of the intended stem extension.

Appendix A – Crossover Technique (cont.)

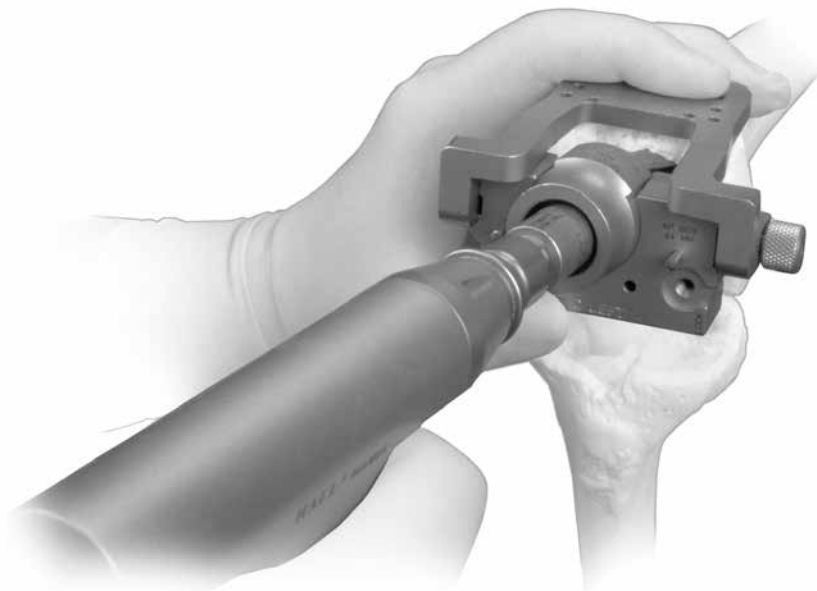


Figure 76

Drill Femoral Canal

Insert the 16–18 mm femoral guide bushing into the femoral stem base/cutting block. Using the 18 mm femoral stem drill, enlarge the diameter of the canal to the second engraved line for an LCKK Femoral Component (Figure 76). Remove the cutting block, flange, and bushing.

Insert Provisional Assembly

Insert the appropriate size straight stem extension provisional into the appropriate size femoral provisional/cutting guide. Insert the provisional assembly onto the bone. Then return to STEP SIX—Establish Flexion Gap and Stability.

Appendix B – Resecting the Distal Femur

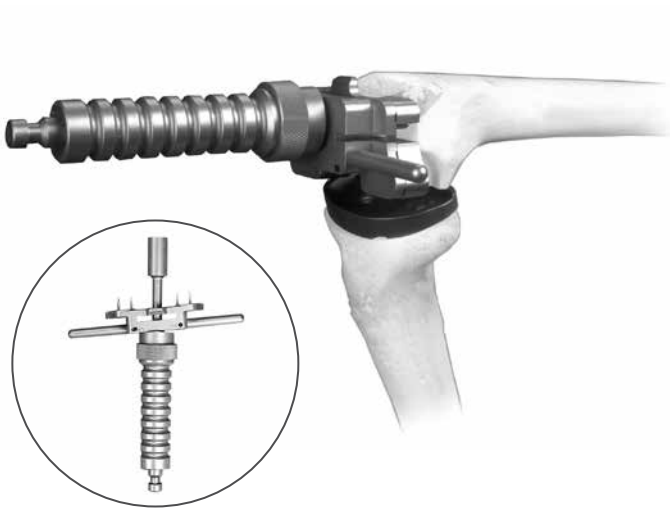


Figure 77

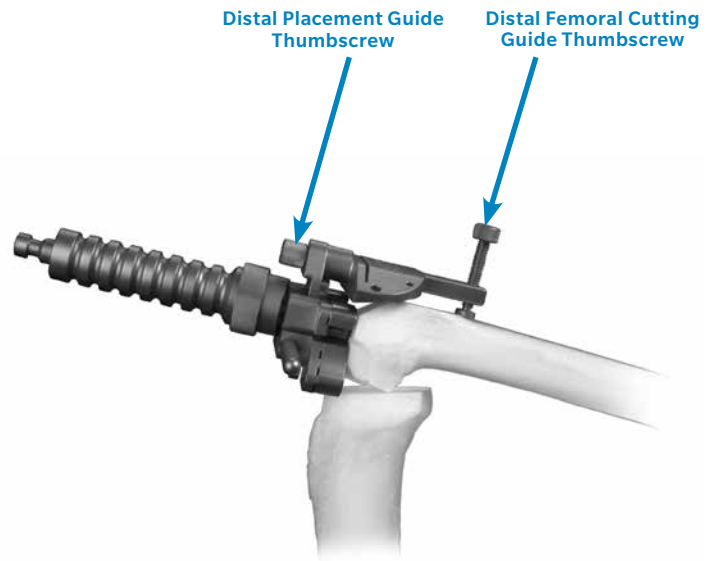


Figure 78

Resecting the Distal Femur

Attach the standard revision cut block to the revision IM guide. Set the revision IM guide to either “R” or “L”. Then attach the straight stem extension provisional to the guide. Insert the stem provisional and IM guide into the femoral canal. Impact the guide onto the distal femur (Figure 77).

Note: After impaction check to ensure that the guide has remained on the correct “Right” or “Left” designation. Because the stem location of the LCKK Femoral Component is oriented in 6° of valgus, the IM guide is designed to yield a 6° valgus cut.

Attach the distal femoral cutting guide to the 0° distal placement guide. Attach the cutting guide/ placement guide assembly onto the revision IM guide. Turn the thumb screw on the distal femoral cut guide only until it contacts the anterior femur (Figure 78). This will help stabilize the cutting guide. Once it has contacted bone, do not turn the screw further. Secure the distal femoral cutting guide by inserting two headless holding pins through the holes marked “0” on the top of the guide. Fully loosen the thumb screw of the 0° distal placement guide. Use the femoral extractor to remove the revision IM guide and the stem extension provisional.

Appendix B – Resecting the Distal Femur (cont.)



Figure 79

Resecting the Distal Femur (cont.)

Use a 0.050-inch/1.27 mm oscillating saw blade to make a minimal resection of the distal femur through the slot on the cutting guide (Figure 79). Additional 2 mm adjustments may be made by using the sets of holes marked -4, -2, +2, and +4. The markings on the cutting guide indicate, in millimeters, the amount of bone resection each will yield relative to the standard distal resection set by the revision IM guide and the selected cut block. Remove the distal femoral cutting guide. Then return to STEP FOUR — Evaluate Femoral Size.

Appendix C – Balancing Flexion/Extension Gaps

Balancing Flexion/Extension Gaps

After the flexion gap has been established and the appropriate size femoral component applied, extend the knee. A symmetrical and balanced extension gap should be created. This is sometimes difficult as it often requires elevation or lowering of the joint line. The patella helps determine the appropriate position of the joint line.

It is important to remember that adjustments to the femoral side of the arthroplasty can affect the knee in either flexion or extension, while any change to the tibia affects both flexion and extension. This is part of the rationale for reconstructing the tibial side first. The following matrix (Figure 79) suggests the nine situations that can occur during a trial reduction in a revision knee. It is worth reviewing these options and some of their potential solutions.

		Extension		
		Tight	OK	Loose
Flexion	Tight	1	2	3
	OK	4	5	6
	Loose	7	8	9

Figure 80

1. If a knee is too tight in both flexion and extension, reducing the height of the tibial articular surface may be sufficient to balance the construct.
2. If the knee is tight in flexion, but acceptable in extension, two options exist. An augment may be used with the distal femur. This will drop the joint line lower, and allow the use of a thinner tibial component. Another option is to use a smaller femoral component.
3. If the joint is loose in extension and tight in flexion, augmentation of the distal femur should provide a good arthroplasty with a thinner polyethylene component if the joint line is at its proper location. Another option is to use a smaller femoral component possibly with a thicker polyethylene component.

4. If the joint is acceptable in flexion, but tight in extension, several options exist. One is to release the posterior capsule from the femur. Another alternative is to resect more distal femoral bone. This moves the femoral component proximally on the femur at the expense of elevating the joint line.
5. Obviously, if both components are acceptable, no further modification is necessary.
6. If the joint is acceptable in flexion and loose in extension, the probable solution is augmentation of the distal femur while using the same polyethylene component. This will drop the joint line and tighten the extension gap. Another option is to downsize the femoral component and use a thicker polyethylene component. This will probably raise the joint line.
7. If the joint is loose in flexion and tight in extension, a larger femoral component, may suffice. A second option is a thicker tibial articular surface with a more proximal femoral position.
8. If the joint is loose in flexion and acceptable in extension, increasing the femoral size may equalize the gaps. Alternatively, moving the femoral component proximally and applying a thicker tibial articular surface will equalize the gaps. As a less desirable solution, one may choose to accept this situation if it is only of a mild degree, particularly in a highly constrained component.
9. If the joint is symmetrically loose in both flexion and extension, a thicker tibial articular surface will usually solve both problems.

In situations where two options exist to help solve the soft tissue mismatch, the position of the patella or the joint line help the surgeon decide which option to select.

Note: After applying one of these solutions, perform another trial reduction. This will identify any new problem or a variation of the initial problem that now may exist.

The Zimmer Revision Knee Arthroplasty Surgical Guidelines is strongly recommended for a more complete discussion on revision total knee arthroplasty technique.

Appendix D – Using MICRO-MILL/(5-in-1) Instrumentation System for a LCCK Primary Procedure

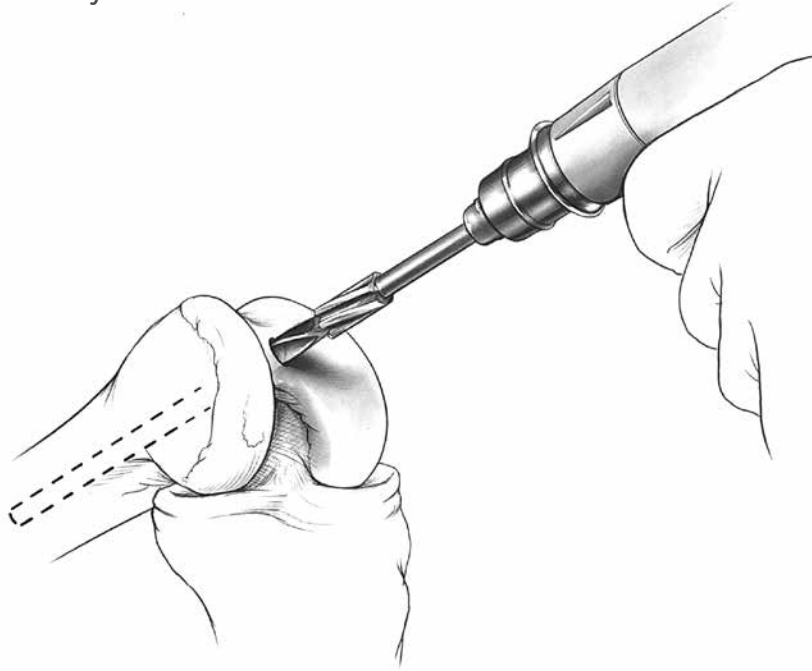


Figure 81

Using MICRO-MILL Instruments for a LCCK Primary Procedure

The MICRO-MILL Instrumentation System can be used to prepare a primary femur for an LCCK Femoral Component. The tibia can be prepared before or after the femur. To prepare the tibia first, complete STEP ONE – Determine Tibial Prosthetic Platform, and STEP TWO – Finish the Tibia. Then proceed with the following steps.

Size the Femur

Drill a hole in the center of the patellar sulcus of the distal femur (Figure 81), making sure that the hole is parallel to the shaft of the femur in both the anteroposterior and lateral projections. The hole should be approximately 1 cm anterior to the origin of the posterior cruciate ligament. The drill is a step drill and should be used to enlarge the entrance hole on the femur to 12 mm in diameter. This will reduce intramedullary pressure from placement of subsequent intramedullary guides.

Insert the IM femoral A/P sizing guide into the hole until it contacts the distal femur. Compress the guide until the anterior boom contacts the anterior cortex of the femur, and both feet rest on the cartilage of the posterior condyles. Placing the guide in flexion or extension can produce inaccurate readings.

Appendix D – Using MICRO-MILL/(5-in-1) Instrumentation System for a LCCK Primary Procedure (cont.)

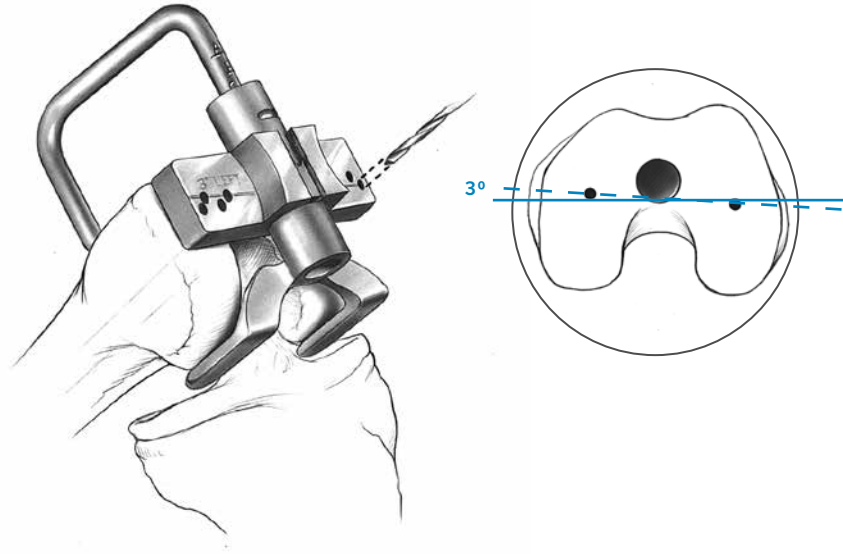


Figure 82

Size the Femur (cont.)

Check to ensure that the boom is not seated on a high spot, or an unusually low spot.

Read the femoral size directly from the guide. If the indicator is between two sizes, choose the smaller size. This size indicates the proper size of the stemmed femoral A/P placement guide, the femoral milling template or 5-in-1 Femoral cutting guide, the femoral finishing guide (milling or 5-in-1), and the femoral component. The sizing can be confirmed at the alignment stage.

The IM femoral A/P sizing guide can also be used to aid in setting 3° of external rotation of the femoral component in relation to the non-deformed posterior condyle (Figure 82). Select and drill through the appropriate holes in the guide being sure that the proper “Right” or “Left” indication is used. Drill one hole on each side medial and lateral. This will place two reference holes on the femur at 3° of external rotation. These holes will be used in conjunction with the revision IM guide to set rotation.

Appendix D – Using MICRO-MILL/(5-in-1) Instrumentation System for a LCKK Primary Procedure (cont.)

Prepare the Femoral Canal

Beginning with the 9 mm intramedullary reamer, progressively ream the femoral canal. Care should be taken so that the reamer is passed in line with the center of the femoral shaft both in the A/P and M/L planes. Avoid eccentric reaming of the femoral shaft. The appropriate diameter of the final reamer should be estimated in preoperative planning, and is confirmed when cortical bone contact is made.

Note the diameter and depth of the last reamer used. To accommodate the stem base of the LCKK Femoral Component, the surgeon must ream 18 mm in diameter to the depth of the stem base and stem extension shoulder, which is 6 cm for the LCKK Component.

Note: An additional 1 cm of reaming is necessary because, in a subsequent step, 1 cm of distal femur will be removed.

If cortical bone contact is made before an 18 mm-diameter reamer is used, continue reaming to 18 mm to a depth of 7 cm to facilitate removal of distal femoral bone and accommodate the femoral provisional/cutting guide stem base. Alternatively, the 18 mm femoral stem drill can be used to complete the canal preparation necessary to accommodate the stem base.

Note: If desired, the femoral stem base instruments can be used to drill for the stem base (See STEP FIVE – Establish Femoral Rotation).

Attach the standard cut block to the revision IM guide. If a large flexion contracture exists or, for other reasons, 3 mm of additional distal femoral bone needs to be resected, remove the standard cut block.

Note: The standard cut block is not the same as the standard revision cut block.

Then attach the straight stem extension provisional, which corresponds to the depth of reaming and the diameter of the last reamer used, to the revision IM guide. Be sure that the revision IM guide is set for “Left” or “Right” depending on the side of the surgery. Because the stem location of the LCKK Femoral Component is oriented in 6° of valgus, the IM guide is designed to yield a 6° valgus cut.

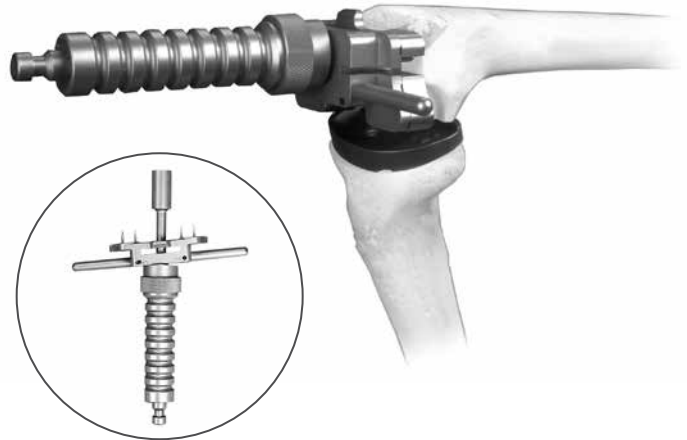


Figure 83

Insert the revision IM guide into the femoral canal.

Using the transepicondylar axis as a reference, align the handles of the guide to set the desired rotation. If holes were drilled to establish 3° of external rotation in the previous step, align the slots in the guide with the holes. If needed, 1/8-inch pins can be used to aid alignment with the pin going through the alignment slot on the IM guide and into the alignment holes. Once the proper rotation is achieved, impact the revision IM guide until it seats on the most prominent condyle.

Note: After impaction check to ensure that the guide has remained on the correct “Right” or “Left” designation.

Appendix D – Using MICRO-MILL/(5-in-1) Instrumentation System for a LCKK Primary Procedure (cont.)

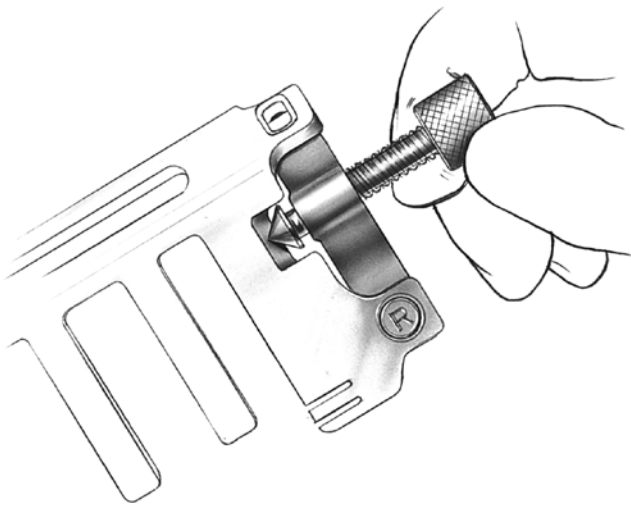


Figure 84

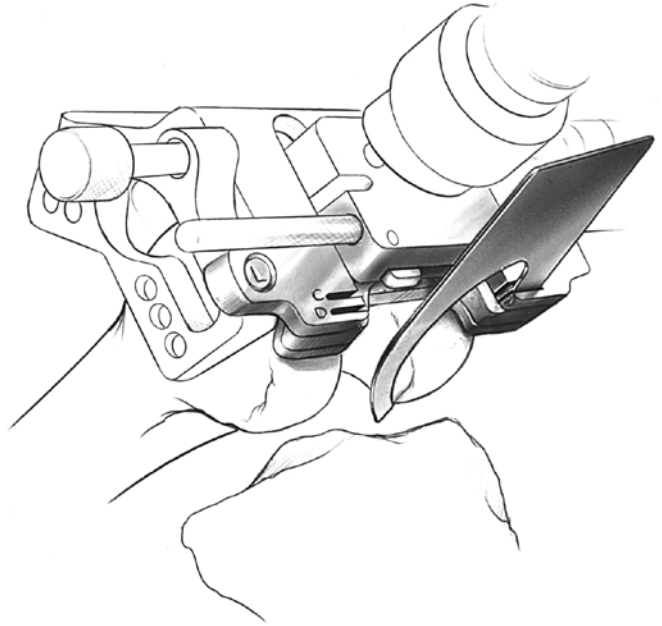


Figure 85

Set A/P Position of the Femur

While the revision IM guide is being inserted by the surgeon, the scrub nurse should attach the two standard femoral mounting bases to the correct size femoral A/P placement guide or stemmed femoral A/P placement guide as determined in the sizing step. The stemmed femoral A/P placement guide is preferred. Tighten the thumb screws. The bases are right/left specific with “R” and “L” indications and can only be assembled in the correct orientation (Figure 84).

Insert the appropriate femoral A/P placement guide with bases attached into the revision IM guide until it contacts the stop on the top of the IM guide. If using the femoral A/P placement guide, slide the boom medially prior to inserting. The A/P position for this guide is established by the stem extension provisional in the reamed canal. It may be necessary to adjust the anterior and posterior femoral condyle cuts to accommodate the resulting femoral component position.

ⓘ **Note:** The 1/8-inch pins must be removed from the external rotation slots for the stemmed femoral A/P placement guide to seat properly.

The slot(s) on the posterior aspect of the femoral A/P placement guide correspond to the posterior femoral resection of the femoral size(s) covered by the guide. This resection level can be checked by placing the resection guide through the slot(s) (Figure 85).

ⓘ **Note:** More external rotation typically results in removal of more bone on the medial posterior condyle. Depending on posterior condylar bone loss, this may vary.

If the posterior resection level is not satisfactory, the femoral sizing steps should be re-evaluated.

Appendix D – Using MICRO-MILL/(5-in-1) Instrumentation System for a LCKK Primary Procedure (cont.)

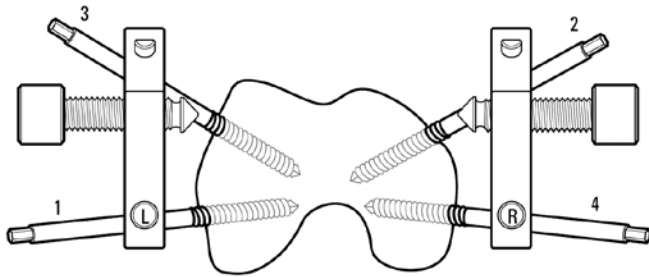


Figure 86

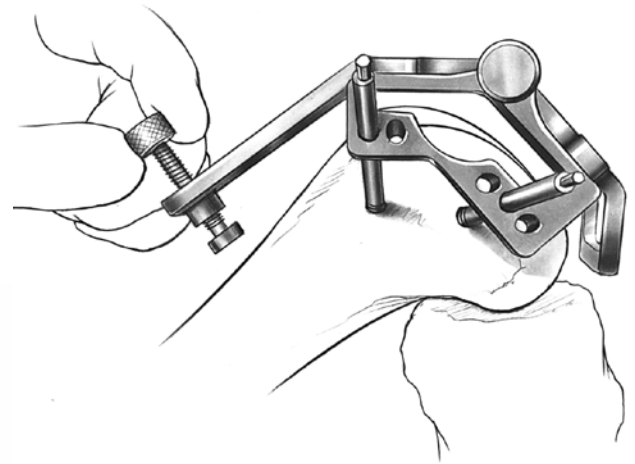


Figure 88

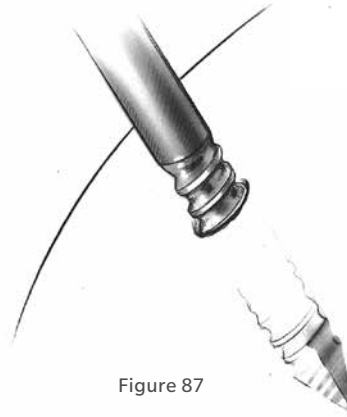


Figure 87

Secure Femoral Mounting Bases

By hand, insert two fixation pins into each side of the two femoral mounting bases. Use the holes that are farthest apart and do not impinge soft tissue. Then, while holding the stemmed femoral A/P placement guide to ensure that it is still touching the stop on the revision IM guide, use the female hex driver and drill/reamer to drive each pin into the bone in the order indicated (Figure 86).

The drill/reamer should be set to the “screw” position. To prevent galling while screwing a pin in, ensure that the pin remains parallel to the hole. Do not completely bury the threaded portion within the bone. Leave one or two threads visible (Figure 87).

Loosen the two thumb screws on the femoral mounting bases until they are completely free of the femoral A/P placement guide. Remove the placement guide and revision IM guide with the slaphammer extractor.

Femoral Resection (Milling)

Attach the proper size femoral milling template onto the two femoral mounting bases.

If the template contacts the tibia, flex the knee further. Secure the template by turning the thumb screws on the two bases until they lock on the template. To further stabilize the template, turn the anterior screw by hand until it contacts the anterior femoral cortex (Figure 88). Do not over tighten. Check to ensure that there is no soft tissue in the area below the template.

The quadriceps muscle and tendon, as well as the patella, must be protected.

ⓘ **Note:** The milling depth resection guide can be used at this time to verify that the template is correctly positioned for the proper depth of resection.

Use the MICRO-MILL handpiece to resect the femur. Move the mill through the track of the template in a clockwise direction, while keeping the mill against the outside edge of the track (Figure 88). Repeat this procedure using each of the template tracks, moving from anterior to posterior. The milling procedure can be stopped at any time. The mill and template can be removed to provide a clear view of the milled surface, then reattached to complete the milling without loss of accuracy.

Appendix D – Using MICRO-MILL/(5-in-1) Instrumentation System for a LCKK Primary Procedure (cont.)

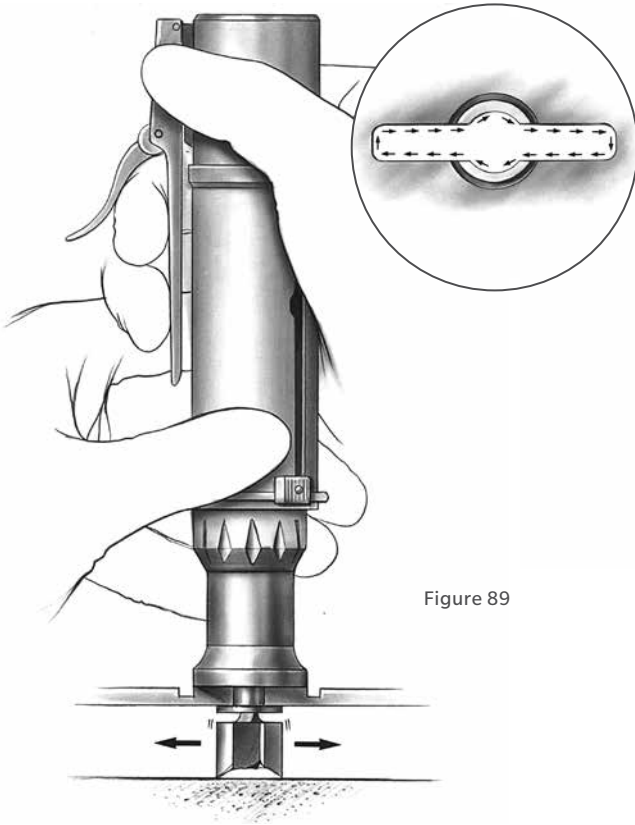


Figure 89

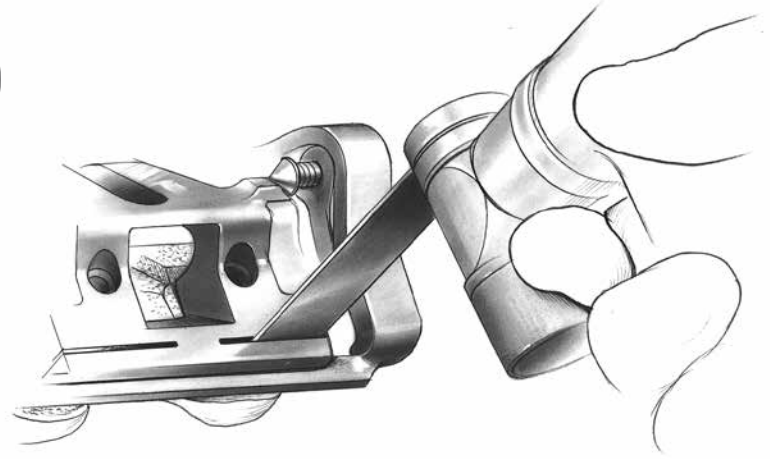


Figure 90

Femoral Resection (Milling) (cont.)

ⓘ **Note:** For more details about using the MICRO-MILL Instrumentation System, see the NexGen CR Surgical Technique.

When all four sections have been milled, remove the mill and template. Check the surfaces of the milled bone. If milling is complete, proceed with the next step. If any areas are unmilled, reattach the femoral milling template and remill the unfinished sections. In some cases, there may be a small step on the anterior cortex since the mill is contained in the template, preventing the cut from extending up the femur. If so, blend it into the anterior cortex with a saw or file.

Posterior Condyle Resection (Milling)

Place the appropriate size femoral finishing guide onto the femoral mounting bases. Center the guide mediolaterally on the distal femur. Use the mounting base thumbscrews for final mediolateral adjustment and secure the guide by tightening both thumbscrews.

Use the appropriate thickness (0.050-inch/1.27 mm) blade and an oscillating saw to cut the posterior condyles (Figure 89). Ensure that the proper thickness blade is used to yield the optimum cut and implant fit. Remove the femoral finishing guide. **Ensure that all cuts are complete before removing the two femoral mounting bases.** It may be necessary to adjust the anterior and posterior femoral condyle cuts to accommodate the resulting femoral component position.

Proceed to STEP SIX – Establish Flexion Gap and Stability and continue through STEP TWELVE – Component Implantation.

Appendix D – Using MICRO-MILL/(5-in-1) Instrumentation System for a LCKK Primary Procedure (cont.)

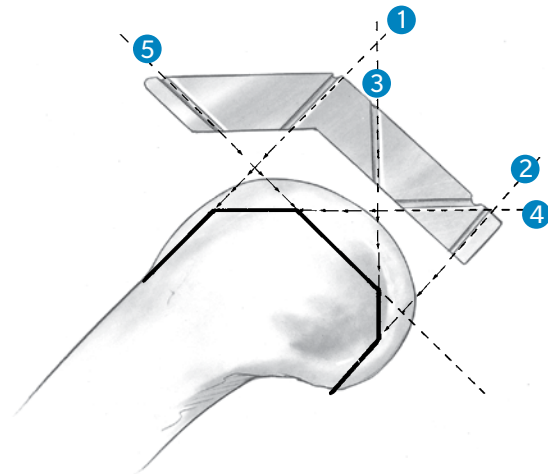


Figure 91

- 1 Anterior
- 2 Posterior
- 3 Posterior Chamfer
- 4 Anterior Chamfer
- 5 Distal

Femoral Resection (5-in-1)

Attach the proper size 5-in-1 femoral cutting guide onto the two femoral mounting bases. If the guide does not seat, check for and remove any osteophytes or bone that is causing interference. Lock the cutting guide into position by firmly turning the thumb screws on the two bases. Check to be sure that there is no soft tissue in the area below the guide.

Note: If template is not firmly locked into position, vibration can loosen the thumb screws.

For the most accurate cuts, perform the femoral cuts through the slots in the order indicated on the guide (Figure 91).

The guide can be removed at any time to check the cuts and be reattached to the bases to finish the cuts without loss of accuracy. For precision cuts, one must use the appropriate thickness (0.050-inch/1.27 mm) saw blade. When all cuts are complete, remove the 5-in-1 femoral cutting guide and the femoral mounting bases. It may be necessary to adjust the anterior and posterior femoral condyle cuts to accommodate the resulting femoral component position.

Proceed to STEP SIX – Establish Flexion Gap and Stability and continue through STEP TWELVE – Component Implantation.

Appendix E – MICRO-MILL/(5-in-1) Instrumentation System for a LCCK Revision Procedure

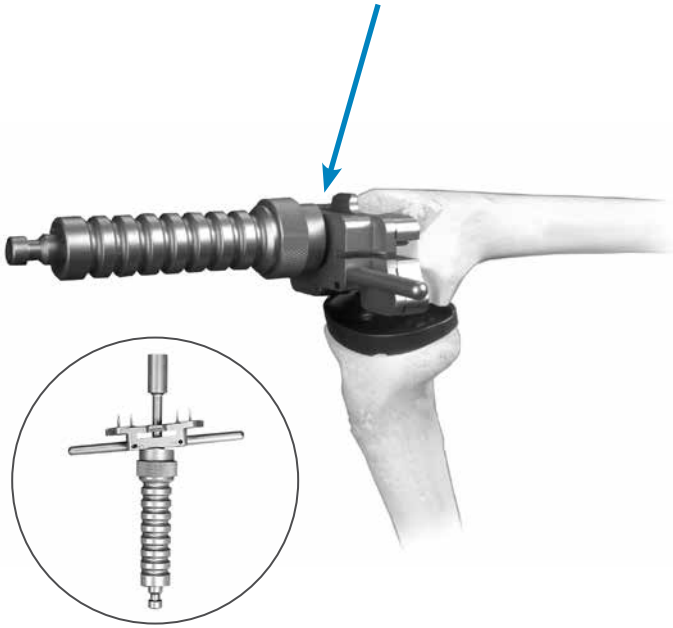


Figure 92

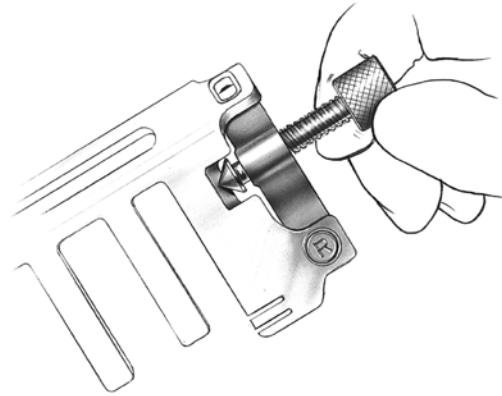


Figure 93

Using MICRO-MILL Instruments for a LCCK Revision Procedure

The MICRO-MILL Instrumentation System can be used to prepare the femur for an LCCK revision procedure. To begin, follow STEPS ONE-FOUR of the LCCK technique. Then proceed with the following steps.

Establish Femoral Alignment

Confirm that the standard revision cut block is attached to the revision IM guide and that the guide is set to the appropriate “L” or “R” side. This combination will result in 1 mm of distal femoral resection. Reinsert the revision IM guide assembly into the femoral canal. Using the transepicondylar axis as a reference, align the handles of the guide to set the desired rotation. Once the proper rotation is achieved, impact the revision IM guide until it seats on the distal surface of the femur.

Note: It must be confirmed that the revision cutting block is attached to the revision IM guide. Use of a different cutting block will allow excessive bone to be removed from the distal femur.

Set A/P Position of the Femur

While the revision IM guide is being inserted by the surgeon, the scrub nurse should attach the two standard femoral mounting bases to the correct size femoral A/P placement guide or stemmed femoral A/P placement guide as determined in the sizing step. The stemmed femoral A/P placement guide is preferred. Tighten the thumb screws. The bases are right/left specific with “R” and “L” indications and can only be assembled in the correct orientation (Figure 93).

Insert the femoral A/P placement guide with bases attached into the revision IM guide until it contacts the stop on the top of the IM guide. The A/P position for this guide was established by the stem extension provisional in the reamed canal. It may be necessary to adjust the anterior and posterior femoral condyle cuts to accommodate the resulting femoral component position.

Appendix E – MICRO-MILL/(5-in-1) Instrumentation System for a LCKK Revision Procedure (cont.)

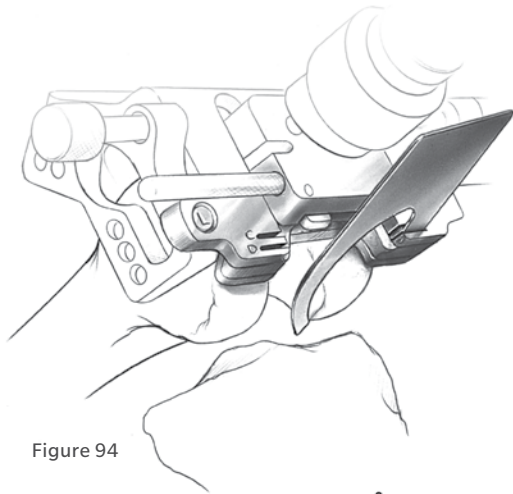


Figure 94

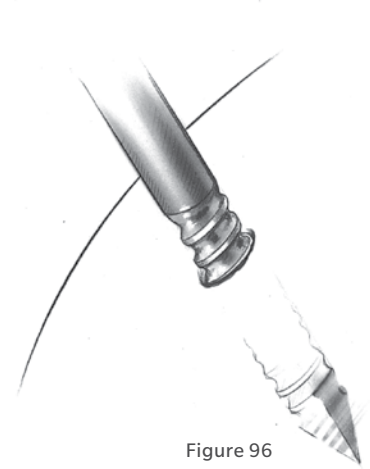


Figure 96

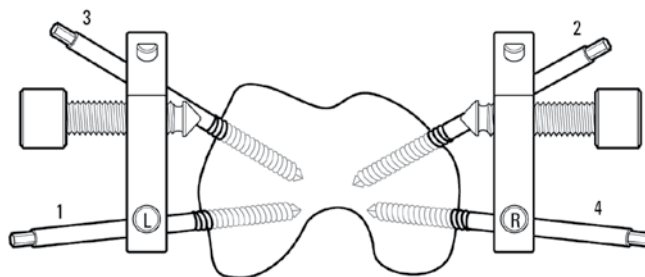


Figure 95

Set A/P Position of the Femur (cont.)

The slot(s) on the posterior aspect of the femoral A/P placement guide correspond to the posterior femoral resection of the femoral size(s) covered by the guide. This resection level can be checked by placing the resection guide through the slot(s) (Figure 94).

ⓘ **Note:** More external rotation typically results in removal of more bone on the medial posterior condyle. Depending on posterior condylar bone loss, this may vary.

If the posterior resection level is not satisfactory, the femoral sizing steps should be re-evaluated.

Secure Femoral Mounting Bases

By hand, insert two fixation pins into each side of the two femoral mounting bases.

Use the holes that are farthest apart and do not impinge soft tissue. Then, while holding the stemmed femoral A/P placement guide to ensure that it is still touching the stop on the revision IM guide, use the female hex driver and drill/reamer to drive each pin into the bone in the order indicated (Figure 95).

The drill/reamer should be set to the “screw” position. To prevent galling while screwing a pin in, ensure that the pin remains parallel to the hole. Do not completely bury the threaded portion within the bone. Leave one or two threads visible (Figure 96).

Loosen the two thumb screws on the femoral mounting bases until they are completely free of the stemmed femoral A/P placement guide. Remove the placement guide and revision IM guide with the slaphammer extractor.

Appendix E – MICRO-MILL/(5-in-1) Instrumentation System for a LCKK Revision Procedure (cont.)

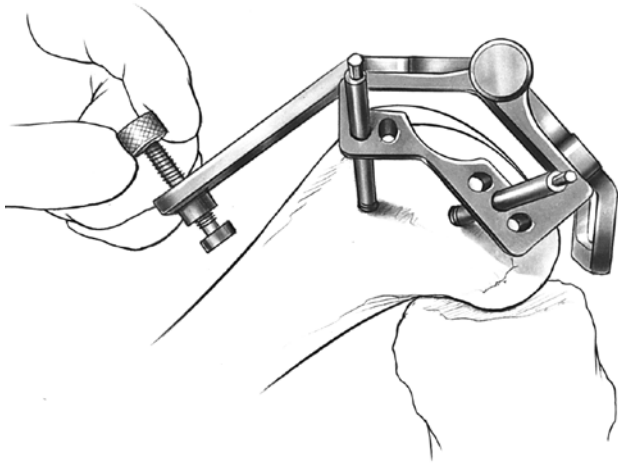


Figure 97

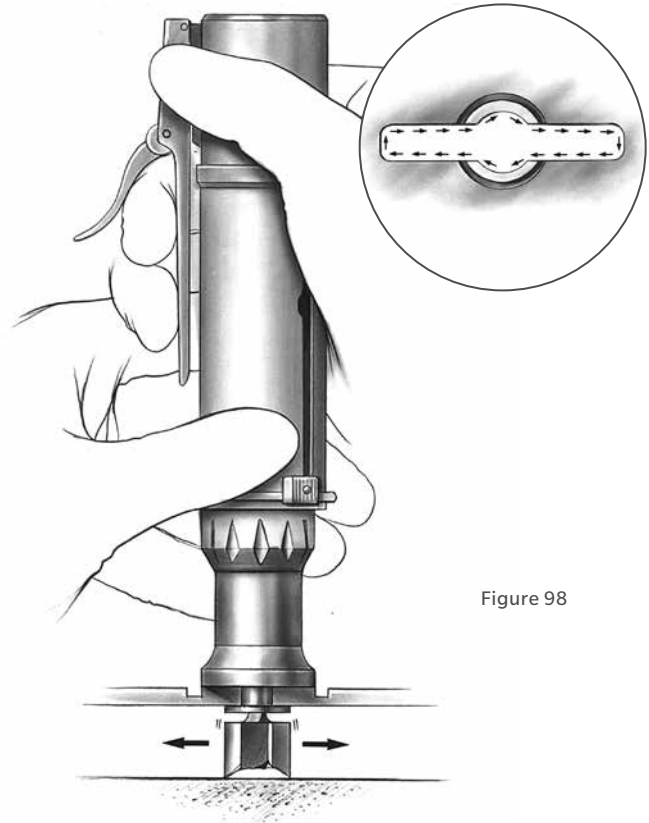


Figure 98

Femoral Resection (Milling)

Attach the proper size femoral milling template onto the two femoral mounting bases. If the template contacts the tibia, flex the knee further. Secure the template by turning the thumb screws on the two bases until they lock on the template. To further stabilize the template, turn the anterior screw by hand until it contacts the anterior femoral cortex (Figure 97). Do not overtighten. Check to ensure that there is no soft tissue in the area below the template.

The quadriceps muscle and tendon, as well as the patella, must be protected.

ⓘ **Note:** The milling depth resection guide can be used at this time to verify that the template is correctly positioned for the proper depth of resection.

Use the MICRO-MILL Handpiece to resect the femur. Move the mill through the track of the template in a clockwise direction, while keeping the mill against the outside edge of the track (Figure 98).

Repeat this procedure using each of the template tracks, moving from anterior to posterior. The milling procedure can be stopped at any time. The mill and template can be removed to provide a clear view of the milled surface, then reattached to complete the milling without loss of accuracy.

ⓘ **Note:** For more details about using the MICRO-MILL Instrumentation System, see the NexGen CR Surgical Technique.

When all four sections have been milled, remove the mill and template. Check the surfaces of the milled bone. If milling is complete, proceed with the next step. If any areas are unmilled, reattach the femoral milling template and remill the unfinished sections. In some cases, there may be a small step on the anterior cortex since the mill is contained in the template, preventing the cut from extending up the femur. If so, blend it into the anterior cortex with a saw or file.

Appendix E – MICRO-MILL/(5-in-1) Instrumentation System for a LCKK Revision Procedure (cont.)

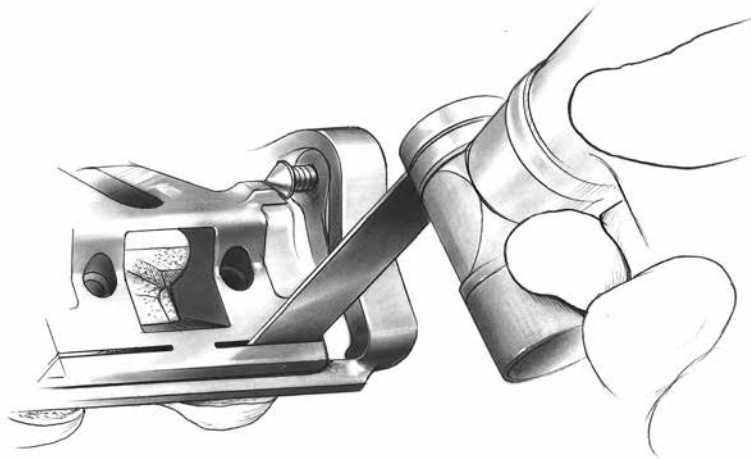


Figure 99

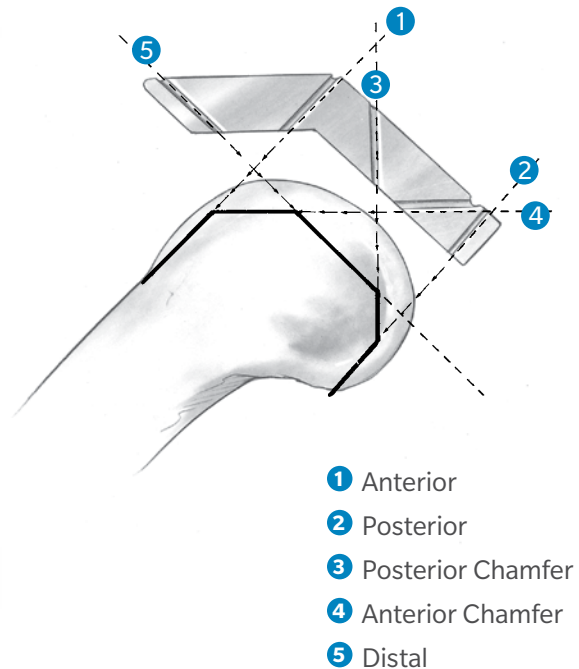


Figure 100

Posterior Condyle Resection (Milling)

Place the appropriate size femoral finishing guide onto the femoral mounting bases. Center the guide mediolaterally on the distal femur. Use the mounting base thumbscrews for final mediolateral adjustment and secure the guide by tightening both thumbscrews.

Use the appropriate thickness (0.050-inch/1.27 mm) blade and an oscillating saw to cut the posterior condyles (Figure 99). Ensure that the proper thickness blade is used to yield the optimum cut and implant fit. Remove the femoral finishing guide.

Ensure that all cuts are complete before removing the two femoral mounting bases. It may be necessary to adjust the anterior and posterior femoral condyle cuts to accommodate the resulting femoral component position.

Proceed to STEP 6 – Establish Flexion Gap and Stability and continue through STEP 12 – Component Implantation.

Femoral Resection (5-in-1)

Attach the proper size 5-in-1 femoral cutting guide onto the two femoral mounting bases.

If the guide does not seat, check for and remove any osteophytes or bone that is causing interference. Lock the cutting guide into position by firmly turning the thumb screws on the two bases. Check to be sure that there is no soft tissue in the area below the guide.

Note: If template is not firmly locked into position, vibration can loosen the thumb screws.

For the most accurate cuts, perform the femoral cuts through the slots in the order indicated on the guide (Figure 100).

The guide can be removed at any time to check the cuts and be reattached to the bases to finish the cuts without loss of accuracy. For precision cuts, one must use the appropriate thickness (0.050-inch/1.27 mm) saw blade. When all cuts are complete, remove the 5-in-1 femoral cutting guide and the femoral mounting bases. It may be necessary to adjust the anterior and posterior femoral condyle cuts to accommodate the resulting femoral component position.

Proceed to STEP SIX – Establish Flexion Gap and Stability and continue through STEP TWELVE – Component Implantation.

Appendix F – Using MICRO-MILL/(5-in-1) Instrumentation System for a LCCK Knee with an Offset Stem

Using MICRO-MILL/(5-in-1) Instrumentation System for a LCCK Knee with an Offset Stem

The 5-in-1 Instrumentation System can be used to prepare the femur for an LCCK revision procedure. To begin, follow Steps 1-4 of the LCCK technique, beginning on page 9. Then resect the distal femur as detailed in Appendix B. At that point an evaluation can be made to determine femoral component position on the end of the femur.

Offset Stem

The offset allows the stem to be positioned 4.5 mm away from the center of the canal in any direction, a full 360 degrees. This may be better understood by thinking of the stem as a crank. As the crank is turned, the handle changes position relative to the shaft. Because the handle can be turned a full 360 degrees, its position can be infinitely changed relative to the shaft.

Use of the offset stem also provides the ability to adjust the femoral component 4.5 mm in any direction off the center of the distal femoral canal. For example, the femoral component can be positioned 4.5 mm anteriorly or posteriorly, 4.5 mm medially or laterally, or any combination of anterior/posterior and medial/lateral orientation that is 4.5 mm from the center of the canal (Figure 100). As shown, for a right femur, this could place the component 3 mm medial and 3 mm anterior to the center of the canal.

Establish Femoral Alignment with an Offset Stem Extension

Determine femoral component placement with the offset stem base instruments. If it appears that the stemmed femoral component with a straight stem extension will not be properly positioned on the distal femur, an offset stem extension is recommended. To prepare for the offset stem, attach the proper diameter straight stem extension provisional to the stem provisional adaptor and insert it into the end of the femur. Then, select the appropriate size femoral stem base cutting block selected in Step 4 and assemble the femoral offset bushing. This bushing does not have a step that locks it into a keyed rotational orientation on the femoral stem base/cutting block. Rotate the bushing within the block until an optimal position is determined.

The femoral offset bushing allows the guide and, therefore, the prosthesis, to be shifted 4.5 mm from the center of the canal in any direction. If the femoral base guide flange prevents appropriate movement, remove the flange. The necessity for anterior bone resection will result, but be careful not to notch the anterior cortex.

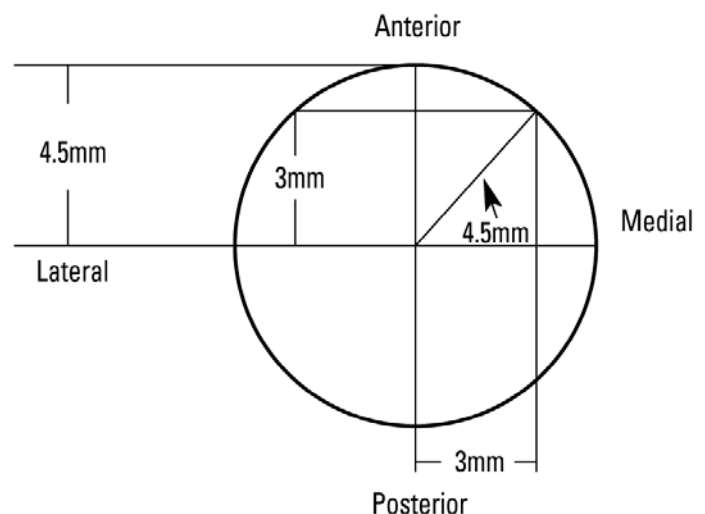


Figure 100

Appendix F – Using MICRO-MILL/(5-in-1) Instrumentation System for a LCKK Knee with an Offset Stem (cont.)

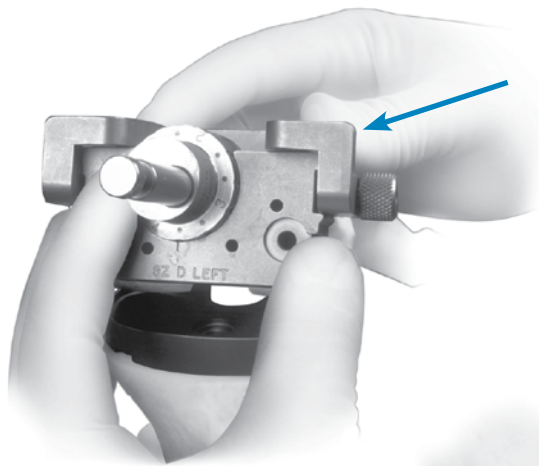


Figure 101

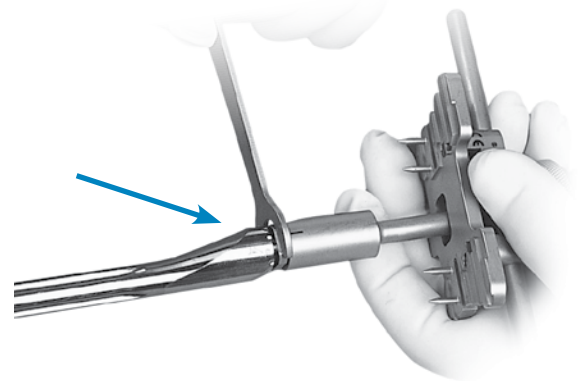


Figure 103

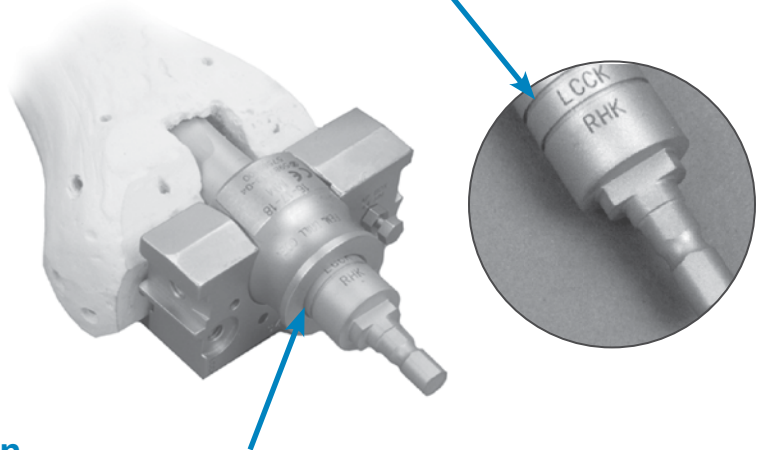


Figure 102

Establish Femoral Alignment with an Offset Stem Extension (cont.)

Note the orientation of the femoral offset bushing by observing the numbers and marks on the bushing relative to the etched line on the posterior face of the femoral stem base/cutting block (Figure 101). This reference will be needed later in the procedure.

When the position of the femoral stem base/cutting block has been established, pin the block in place with two headless holding pins in the upper two holes. Remove the femoral offset bushing. Remove the intramedullary reamer or the stem extension provisional assembly with the femoral extractor. Insert the 16/18 femoral guide bushing into the cutting block.

Attach the femoral stem drill to a drill/reamer and drill through the bushing. Drill to the second engraved line for an LCKK Femoral Component. The depth is indicated on the drill bit (Figure 102).

Note: If it is known that distal femoral augments will be used, the augments should be applied to the posterior surface of the femoral stem base/cutting block prior to use of the 18 mm femoral stem drill.

Confirm that the standard revision cut block is attached to the revision IM guide and that the guide is set to the appropriate “L” or “R” side.

Note: It must be confirmed that the revision cut block is attached to the revision IM guide. Use of other cut blocks will allow excessive bone to be removed from the distal femur.

When using an offset stem, fully thread the offset stem locknut onto the appropriate diameter offset stem extension provisional. Then back thread the locknut until it engages only the first thread. Thread the offset stem extension provisional onto the stem extension housing of the revision IM guide. Rotate the offset stem extension provisional to the position noted earlier on the posterior face of the femoral stem base/cutting block (Figure 103). Align the offset stem extension with the etch mark on the posterior side of the stem extension housing of the revision IM guide. Use the offset wrench to tighten the locknut against the revision IM guide.

Appendix F – Using MICRO-MILL/(5-in-1) Instrumentation System for a LCKK Knee with an Offset Stem (cont.)

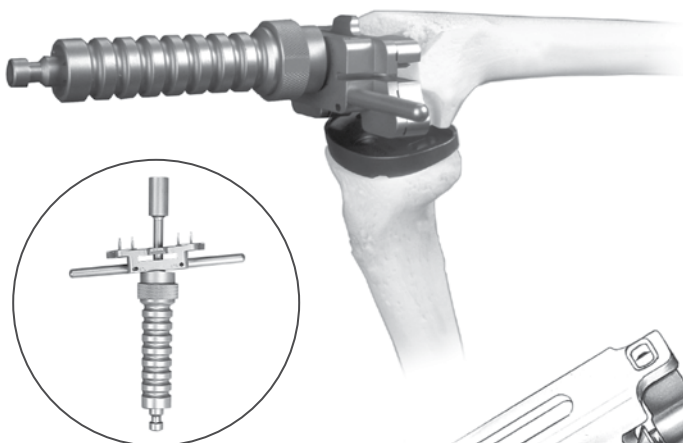


Figure 104

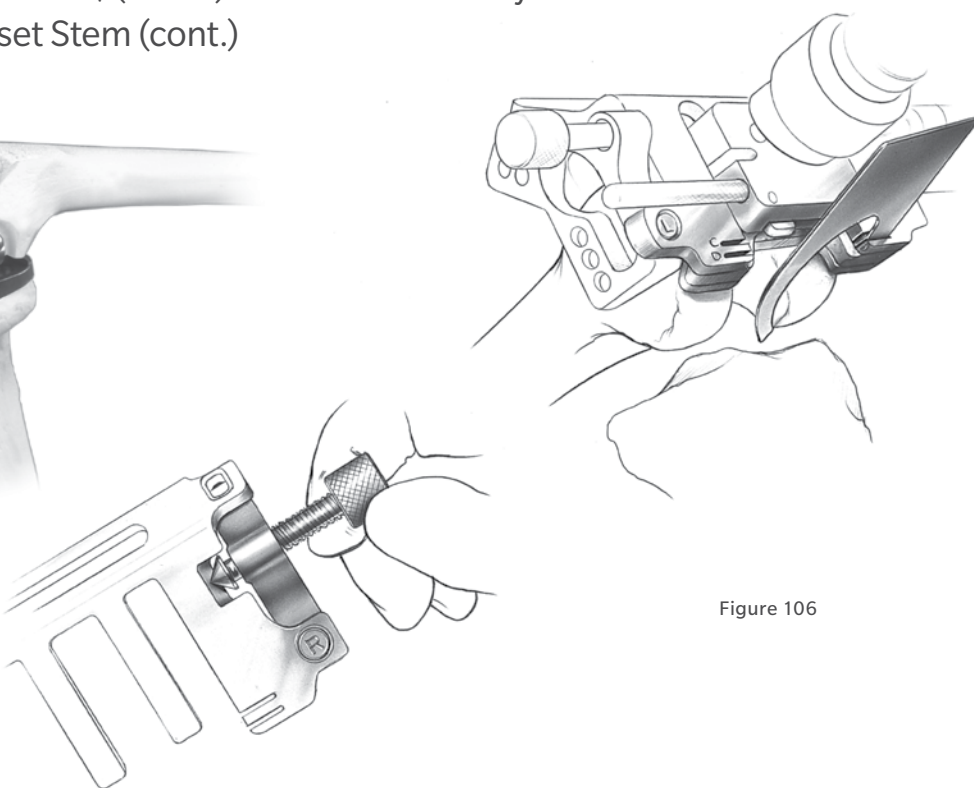


Figure 105

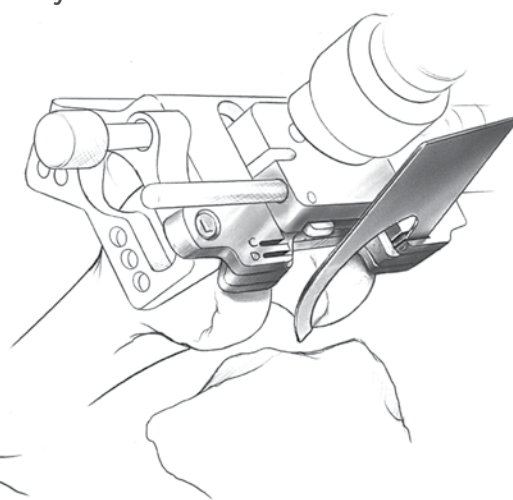


Figure 106

Establish Femoral Alignment with an Offset Stem Extension (cont.)

Insert the revision IM guide assembly into the femoral canal. Using the transepicondylar axis as a reference, align the handles of the guide to set the desired rotation. Once the proper rotation is achieved, impact the revision IM guide until it seats on the distal surface of the femur (Figure 104).

Set A/P Position of the Femur

While the revision IM guide is being inserted by the surgeon, the scrub nurse should attach the two standard femoral mounting bases (micro sizes require separate bases) to the correct size stemmed femoral A/P placement guide as determined in the sizing step. Tighten the thumb screws. The bases are right/left specific with “R” and “L” indications and can only be assembled in the correct orientation (Figure 105).

Insert the stemmed femoral A/P placement guide with bases attached into the revision IM guide until it contacts the stop on the top of the IM guide. The A/P position for this guide was established by the straight stem extension provisional in the reamed canal. It may be necessary to adjust the anterior and posterior femoral condyle cuts to accommodate the resulting femoral component position.

The two slots on the posterior aspect of the stemmed femoral A/P placement guide correspond to the posterior femoral resection of the two femoral sizes covered by the guide. This resection level can be checked by placing the resection guide through the slots (Figure 106). More external rotation results in removal of more bone on the medial posterior condyle.

If neither of the posterior resection levels are satisfactory, the sizing steps should be re-evaluated.

Appendix F – Using MICRO-MILL/(5-in-1) Instrumentation System for a LCKK Knee with an Offset Stem (cont.)

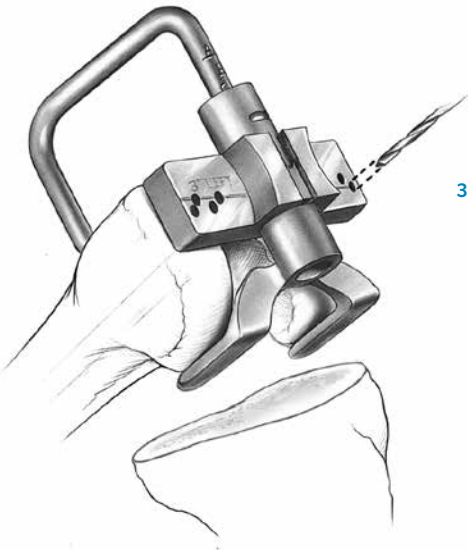


Figure 107

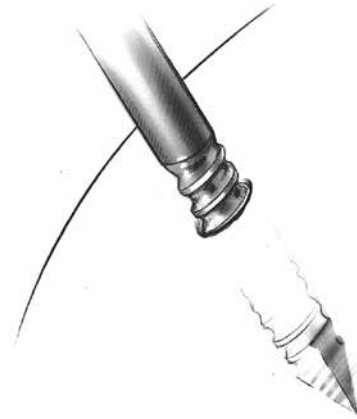
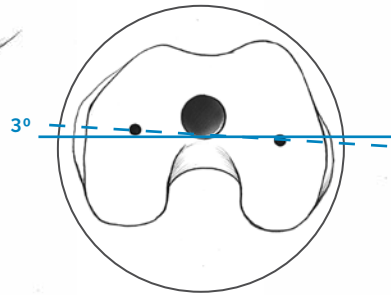


Figure 108

Secure Femoral Mounting Bases

By hand, insert two fixation pins into each side of the two femoral mounting bases. Use the holes that are farthest apart and do not impinge soft tissue. Then, while holding the stemmed femoral A/P placement guide to ensure that it is still touching the stop on the revision IM guide, drive each pin into the bone with the female hex driver and drill/reamer (Figure 107).

The drill/reamer should be set to the “screw” position. To prevent galling while screwing a pin in, ensure that the pin remains parallel to the hole. Do not completely bury the threaded portion within the bone. Leave one or two threads visible (Figure 108).

Loosen the two thumb screws on the femoral mounting bases until they are completely free of the stemmed femoral A/P placement guide. Remove the placement guide and revision IM guide with the saphammer extractor.

Appendix F – Using MICRO-MILL/(5-in-1) Instrumentation System for a LCCK Knee with an Offset Stem (cont.)

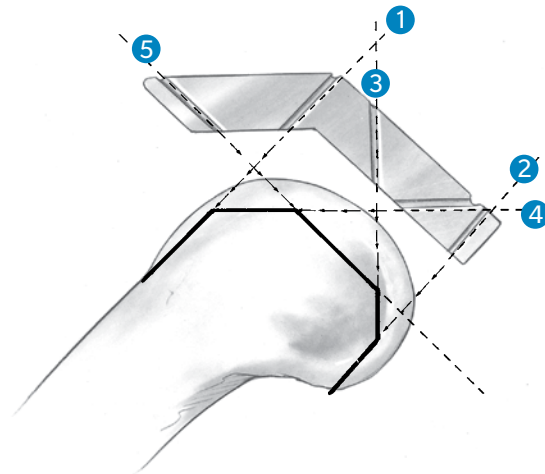


Figure 109

- ① Anterior
- ② Posterior
- ③ Posterior Chamfer
- ④ Anterior Chamfer
- ⑤ Distal

5-in-1 Femoral Resection

Attach the proper size 5-in-1 femoral cutting guide onto the two femoral mounting bases. If the guide does not seat, check for and remove any osteophytes or bone that is causing interference. Lock the cutting guide into position by firmly turning the thumb screws on the two bases. Check to be sure that there is no soft tissue in the area below the guide.

ⓘ **Note:** If template is not firmly locked into position, vibration can loosen the thumb screws.

For the most accurate cuts, perform the femoral cuts through the slots in the order indicated on the guide (Figure 109).

The guide can be removed at any time to check the cuts and be reattached to the bases to finish the cuts without loss of accuracy. For precision cuts, one must use the appropriate thickness (0.050 in./1.27 mm) saw blade. When all cuts are complete, remove the 5-in-1 femoral cutting guide and the femoral mounting bases.

To finish the procedure, proceed to Step 6 of the LCCK surgical technique and continue with Steps 6 through 12.

Appendix G – Augment Compatibility

Tibial Augment Compatibility

NexGen Finned Precoat Tibial Augments

		Full Block (10 mm)								Half Block (5 mm)								Half Block (10 mm)								Half Block Tapered (15 mm) Right-Lateral/Left-Medial							
NexGen Tibial Baseplates	Size	1	2	3	4	5	6	7	8	1	2	3	4	5	6	7	8	1	2	3	4	5	6	7	8	1	2	3	4	5	6	7	8
	Stemmed (Precoat)	1	C								C								C								C						
2			CS								CS								CS								CS						
3				CS								CS								CS								CS					
4					CS								CS								CS								CS				
4+					CS								CS								CS								CS				
5						CS								CS								CS								CS			
6							CS								CS								CS								CS		
7								CS								CS								CS								CS	
8									CS								CS								CS								CS
10																																	
A/P Wedge Stemmed (Precoat)	3			CS								CS								CS								CS					
	4				CS								CS								CS								CS				
	5					CS								CS								CS								CS			
	6						CS								CS								CS								CS		
	7							CS								CS								CS								CS	
	8								CS								CS								CS								CS

CS: Cement or Screw Attachment
C: Cement Attachment Only

NexGen Finned Precoat Tibial Augments (Continued)

		Half Block Tapered (15 mm) Left-Lateral/Right-Medial								Half Block Tapered (20 mm) Right-Lateral/Left-Medial								Half Block Tapered (20 mm) Left-Lateral/Right-Medial								Half Wedge (16°)							
NexGen Tibial Baseplates	Size	1	2	3	4	5	6	7	8	1	2	3	4	5	6	7	8	1	2	3	4	5	6	7	8	2	3	4	5	6	7	8	
	Stemmed (Precoat)	1	C								C								C														
2			CS								CS								CS								CS						
3				CS								CS								CS								CS					
4					CS								CS								CS								CS				
4+					CS								CS								CS								CS				
5						CS								CS								CS								CS			
6							CS								CS								CS								CS		
7								CS								CS								CS								CS	
8									CS								CS								CS								CS
10																																	
A/P Wedge Stemmed (Precoat)	3			CS								CS								CS								CS					
	4				CS								CS								CS								CS				
	5					CS								CS								CS								CS			
	6						CS								CS								CS								CS		
	7							CS								CS								CS								CS	
	8								CS								CS								CS								CS

CS: Cement or Screw Attachment
C: Cement Attachment Only

Appendix G – Augment Compatibility (cont.)

Tibial Augment Compatibility (cont.)

NexGen Fined Precoat Tibial Augments (Continued)																							
		Half Wedge (26°)							Third Wedge (22°)							Full Wedge (7°)							
Size		2	3	4	5	6	7	8	2	3	4	5	6	7	8	2	3	4	5	6	7	8	9
NexGen Tibial Baseplates	Stemmed (Precoat)	1																					
		2	CS							CS							CS						
		3		CS							CS							CS					
		4			CS							CS							CS				
		4+			CS							CS							CS				
		5				CS							CS							CS			
		6					CS							CS							CS		
		7						CS							CS							CS	
		8							CS							CS							CS
		9																					
	10																						
NexGen Tibial Baseplates	A/P Wedge Stemmed (Precoat)	3		CS						CS							CS						
		4			CS						CS								CS				
		5				CS						CS								CS			
		6					CS						CS								CS		
		7						CS						CS								CS	
		8							CS						CS								CS

CS: Cement or Screw Attachment
 C: Cement Attachment Only

Appendix G – Augment Compatibility (cont.)

Femoral Augment Compatibility

NexGen Finned Precoat Femoral Augments

Size	Anterior					Posterior (5 mm)					Posterior (10 mm)					Distal (5 mm)					Distal (10 mm)					Distal Only (10 mm)				
	C	D	E	F	G	C	D	E	F	G	C	D	E	F	G	C	D	E	F	G	C	D	E	F	G	C	D	E	F	G
C Left	C					CS					CS					CS					CS					CS				
C Right	C					CS					CS					CS					CS					CS				
D Left		C				CS					CS					CS					CS					CS				
D Right		C				CS					CS					CS					CS					CS				
E Left			C				CS					CS					CS					CS					CS			
E Right			C				CS					CS					CS					CS					CS			
F Left				C				CS					CS					CS					CS					CS		
F Right				C				CS					CS					CS					CS					CS		
G Left					C				CS					CS					CS					CS					CS	
G Right					C				CS					CS					CS					CS					CS	

CS: Cement or Screw Attachment
 C: Cement Attachment Only

NexGen Finned Precoat Femoral Augments (Continued)

Size	Distal Only (15 mm)					Distal Only (20 mm)					Posterior Only		
	C	D	E	F	G	C	D	E	F	G	E	F	G
C Left	C					CS							
C Right	C					CS							
D Left		C				CS							
D Right		C				CS							
E Left			C				CS				CS		
E Right			C				CS				CS		
F Left				C				CS				CS	
F Right				C				CS				CS	
G Left					C				CS				CS
G Right					C				CS				CS

CS: Cement or Screw Attachment
 C: Cement Attachment Only

References

1. Berger, RA; Crossett, LS; Jacobs, JJ; Rubash, HE. Malrotation causing patellofemoral complications after total knee arthroplasty. *Clinical Orthopaedics and Related Research*. Department of Orthopaedic Surgery, Rush Medical College, Chicago, IL 1998:144-53
2. Insall JN, *Surgery of the Knee*. 3rd ed. New York, NY: Churchill Livingstone; 2001:1556.
3. Poilvache PL, Insall JN, Scuderi GR, Font-Rodríguez DE. Rotational landmarks and sizing of the distal femur in TKA. *Clin Orthop*. 331:35-46, 1996.

All content herein is protected by copyright, trademarks and other intellectual property rights, as applicable, owned by or licensed to Zimmer Biomet or its affiliates unless otherwise indicated, and must not be redistributed, duplicated or disclosed, in whole or in part, without the express written consent of Zimmer Biomet.

This material is intended for health care professionals and the Zimmer Biomet sales force. Distribution to any other recipient is prohibited.

Zimmer Biomet does not practice medicine. This technique was developed in conjunction with health care professionals. This document is intended for surgeons and is not intended for laypersons. Each surgeon should exercise his or her own independent judgment in the diagnosis and treatment of an individual patient, and this information does not purport to replace the comprehensive training surgeons have received. As with all surgical procedures, the technique used in each case will depend on the surgeon's medical judgment as the best treatment for each patient. Results will vary based on health, weight, activity and other variables. Not all patients are candidates for this product and/or procedure.

For product information, including indications, contraindications, warnings, precautions, potential adverse effects and patient counseling information, see the package insert and www.zimmerbiomet.com.

Caution: Federal (USA) law restricts this device to sale by or on the order of a surgeon. Rx only.

Check for country product clearances and reference product specific instructions for use.

Not for distribution in France.

© 2017 Zimmer Biomet



ZIMMER BIOMET
Your progress. Our promise.®

1401.1-GLBL-en REV0517 A4



Legal Manufacturer
Zimmer, Inc.
1800 West Center Street
Warsaw, Indiana 46582
USA

zimmerbiomet.com

CE 0086

CE mark on a surgical technique is not valid unless there is a CE mark on the package label.