

Signature™ ONE Guides

Surgical Technique



Table of Contents

Overview, Indications and Contraindications	2
Surgical Planning Report.....	3
Bone Model Features and Text	5
Signature ONE Guides Features and Text	5
Glenoid Preparation	7
Placing the Signature ONE Pin Guide	8
Inserting Guide Pins	10
Glenoid Preparation	12
Glenoid Preparation –Comprehensive® Anatomic, Reverse, and Augmented Baseplate Procedures.....	12
Glenoid Preparation – Zimmer Biomet TMR+ Shoulder System.....	15
Drill Base Plate Post Hole – Zimmer Biomet TMR+ Shoulder System	19
Baseplate Insertion.....	20
Drill Screw Holes and Insert Screws and Locking Caps – Zimmer Biomet TMR+ Shoulder System.....	21

Overview

The first step in the Signature ONE surgical technique and a precursor to using the Signature ONE Patient Specific guides is to conduct a Pre-Operative Planning process using the Signature ONE Planner. Refer to the Signature ONE Planner software User Guide (807.001) for usage instructions on the application. The surgeon must conduct, review and approve the plan in order to initiate the manufacture of the Signature ONE instrument guides. The output of this process will be the Surgical Planning Report and the manufacturing specifications of the Signature ONE Guides and Bone Model.

In addition, the surgeon can preoperatively plan a surgical case within the Signature ONE Planner without initiating guides by using the Pure Planning option. The output of this process is a digital plan that the surgeon can reference prior to surgery. A summary PDF of the planning report is provided as well.

Indications for Use

The Signature ONE System is indicated, based on patient-specific radiological images with identifiable placement anatomical landmarks, to assist in pre-operative planning and/or intra-operative guiding of surgical instruments for shoulder replacement surgical procedures on patients not precluded from being radiologically scanned.

The Signature ONE System is to be used with the glenoid components of the following shoulder implant systems in accordance with their indications and contraindications: Zimmer® Trabecular Metal Reverse Plus™ Shoulder, Comprehensive Total Shoulder System, Comprehensive Reverse Shoulder System, Comprehensive Reverse Augmented Baseplates and Alliance™ Glenoid System.

The Signature ONE Guides and Bone Models are intended for single use only.

Contraindications

The Signature ONE System should not be used when the patient has metallic devices implanted that could interfere with the CT scan quality. Additionally, the Signature ONE System should not be used in cases where native bone is absent, or where a custom bone augment/graft will be used on surfaces intended to mate with the Signature ONE Guides.

Surgical Planning Report

A copy of the Surgical Planning Report (20-8018-020-00) and patient bone model is provided with the Signature ONE Guides packaging. A hardcopy of the Surgical Planning Report will not be included for Pure Planning. The report includes general case information and the planned position and orientation of the glenoid implant components with related images. This document is to help the surgeon assess whether the Signature ONE Guides and Bone Model represent the pre-operative plan. In addition, the report includes information on the implant sizes, implant systems, and instrumentation options the surgeon selected in his pre-operative planning.

WARNING: Ensure to use the guides with the implant system and the implant size that was planned in order to reproduce the plan accurately. If a different procedure (Anatomic vs. Reverse) or implant size was selected intra-operatively, the Signature ONE guide must not be used and must be discarded.

⊖ Notes:

- Federal (U.S.) law restricts this device to sale by or on the order of a physician.
- Zimmer Biomet strongly recommends formal Signature ONE Guide training prior to use of the system. Contact your local Zimmer Biomet representative or the Zimmer Institute (1-855-ZSurgeon, or 1-855-978-7436) for more information.
- Signature ONE guides are designed to register on the bony surface of the anterior glenoid. Therefore, do not remove any osteophytes or bony landmarks that were previously referenced to build the guide until the guide has been used.
- Given the potential for patient morphological changes, the surgeon has to assess the changes between the time of manufacture and the date of surgery and in case of any doubt the Signature One Guides and bone model must not be used. The Signature ONE Guides and Bone Model have a limited shelf life of 6 months after the manufacturing date, as indicated on the package label. Signature ONE Guides and Bone models should not be used after the expiration date.
- If you experience difficulties with the Signature ONE Guides during surgery, stop using the guides and revert to the standard (non-patient specific) Zimmer Trabecular Metal Reverse Plus (TMR+) Shoulder System surgical technique (Zimmer Biomet Item Number 1423.1-US), Comprehensive Reverse Shoulder Technique (0173.1), Comprehensive Augmented Baseplate Shoulder Technique (0468.1), or Comprehensive Modular Hybrid® Glenoid Technique (1271.1).
- The Surgeon must refer to conventional surgical approach in gauging final implant placement and orientation.
- The Signature ONE Guides and Bone Model are single use, patient specific instrumentation that should be discarded as biohazardous material after surgery.
- The Signature ONE system can be used for the glenoid component, but conventional surgery should be used for the humerus.

Example: SAM123L77DD13UO

Printed on Pin Guide /
 Impactor Guide /
 Screw Guide: 123
 Printed on Reamer Guide: SAM123L
 Printed on Bone Model: SAM123L77DD13UO

S	AM	123	L	77	DD	13	U	O
First letter of patient first name	First two letters of patient last name	Unique index assigned by Zimmer Biomet	Operated side (left/right)	Patient's birth year	Surgeon initials	Year when the case was created	Region where the case ID originated	Identifier for Signature ONE product code assigned on the technology

Figure 1
 Signature ONE Case Identifier

WARNING: Ensure that the delivered Signature ONE Guides and Bone Model correspond to the intended patient. The copy of the Surgical Planning Report is provided in the Signature ONE Guides and Bone Model packaging as well as within the Signature ONE Planner. Use the Signature ONE Guides and Bone Model only if the Zimmer Biomet Case ID markings are both legible on the Signature ONE Guides and Bone Model and match the Signature ONE Case ID specific to the intended patient.

If the Zimmer Biomet Shoulder Case ID markings (Figure 1) on the Signature ONE Guides and Bone Model do not match the Zimmer Biomet Case ID specific to the intended patient, DO NOT USE the Signature ONE Guides and Bone Model on that patient and notify your Zimmer Biomet representative. The Case ID is 15 characters and is automatically assigned. The Case ID nomenclature and marking on the instrument guides and bone model are described in Figure 1.

Bone Model Features and Text

Comprehensive Augmented Baseplate Bone Model

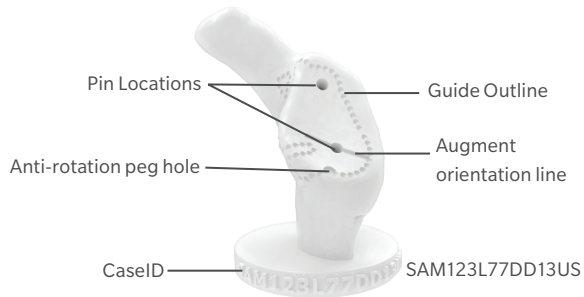

Comprehensive Mini Baseplate Bone Model

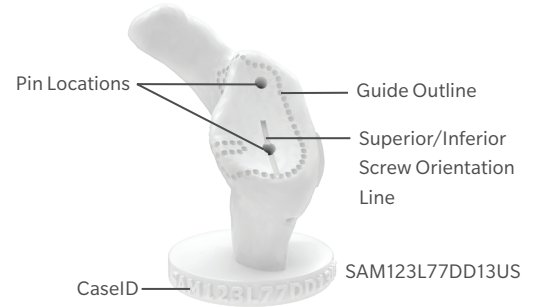

Comprehensive Modular Hybrid Glenoid Bone Model

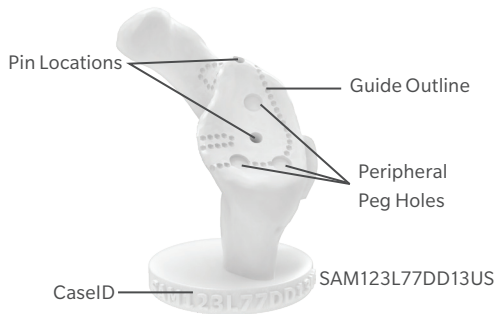

TMR+ Bone Model

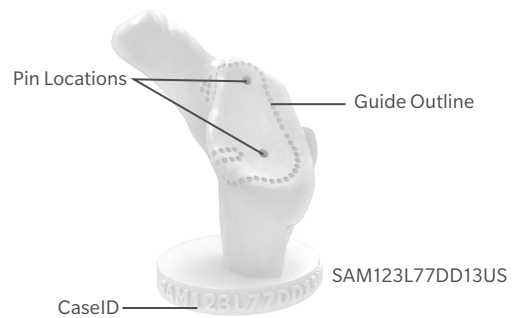

Signature ONE Guides Features and Text

Signature ONE Reverse Pin Guides

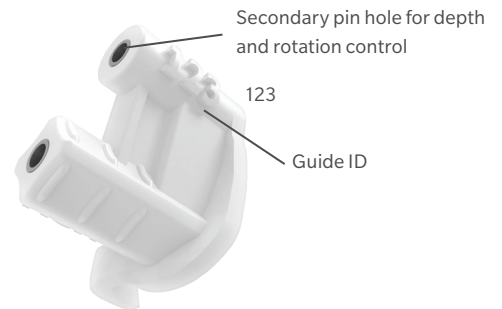
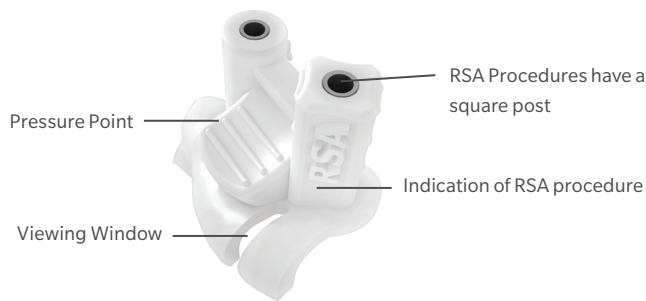

Signature ONE Modular Hybrid Glenoid Pin Guides

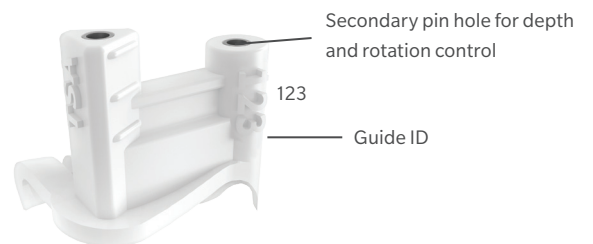
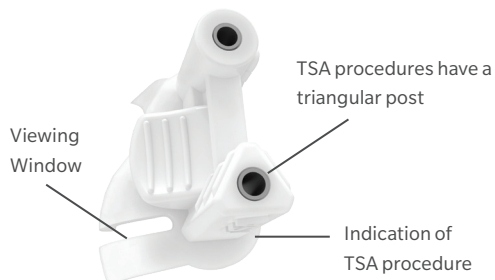

Signature ONE Reamer Guides – Comprehensive Modular Hybrid Glenoid & Comprehensive Reverse Shoulder



Signature ONE Reamer Guides – TMR+



Signature ONE Impactor Guide – TMR+

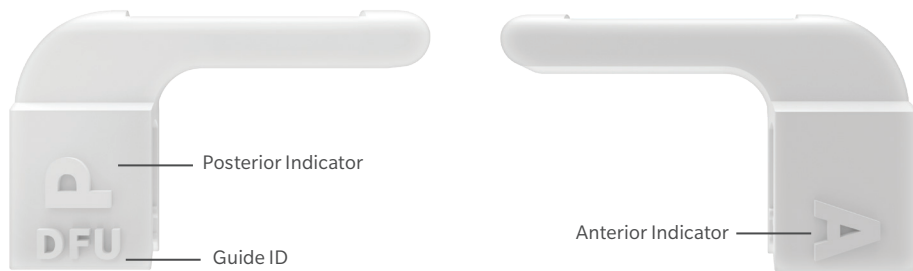

Signature ONE Screw Guide – TMR+

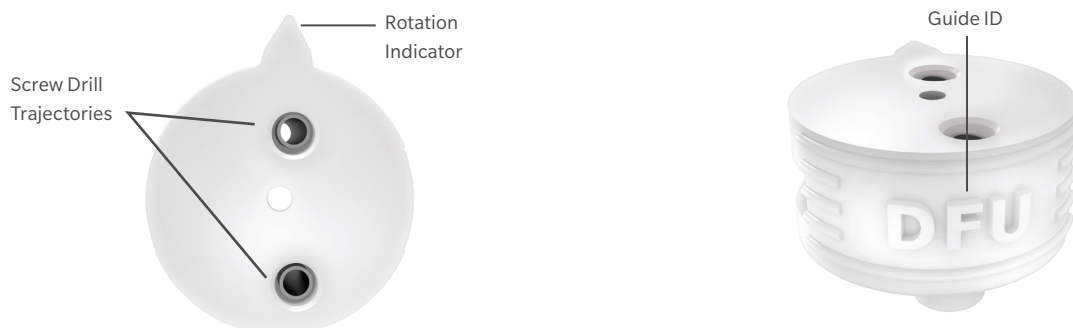

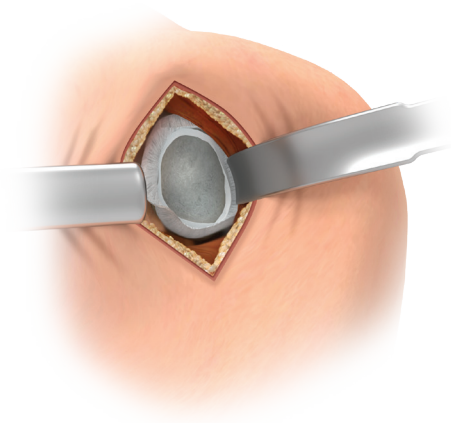

Figure 2
Straight on exposure is necessary.

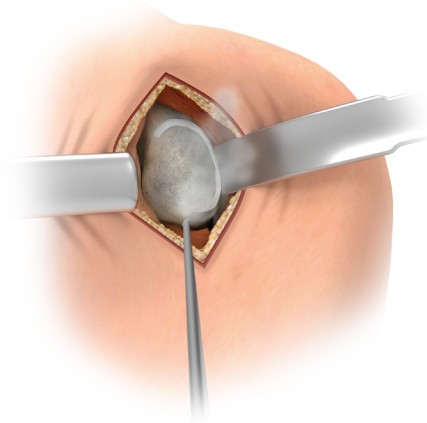

Figure 3
Remove the entire capsulolabral complex from 11 to 6 o'clock

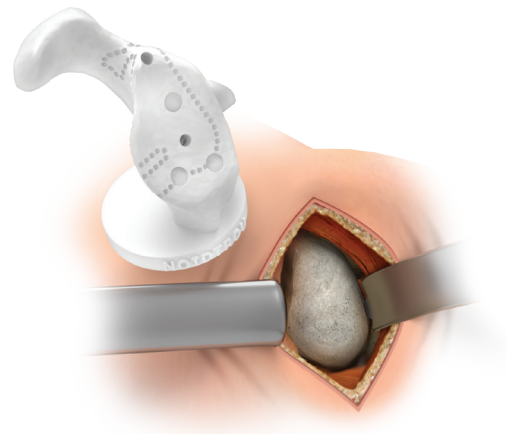

Figure 4
Compare the registration surface of the guide (imprinted on the bone model) to the soft tissue dissection. Ensure that sufficient soft tissue has been removed to allow for complete guide seating.

Glenoid Preparation

Exposure

- ⓘ **Note:** While preparing the glenoid, the retraction of the proximal humerus and humeral head provisional along with retractors should be carefully considered. Their positions may interfere with glenosphere seating. Exposure should allow for straight on engagement of the glenosphere on the base plate taper. Consider use of the Zimmer Biomet Shoulder Shoehorn Retractor as it has been designed to aid in retracting the humeral head and other soft tissue when placed on the posterior side of the glenoid.
- ⓘ **Note:** The Signature ONE Pin Guide was designed to reference the glenoid fossa, the anterior glenoid rim, and the glenoid-coracoid junction. It is important to compare the native glenoid bone with the provided patient specific bone model to ensure that all of the soft tissue has been removed from the area that the guide registers on (Fig. 4). This may be done with direct finger palpation along the entire glenoid surface and coracoid base. This area must be free of interfering soft tissue to allow seating of the pin guide.
- ⓘ **Note:** Signature ONE Guides are designed to register on the bony surface of the anterior glenoid. Therefore, do not remove any osteophytes or bony landmarks that were previously referenced to build the guide until the guide has been used.

Straight-on exposure of the glenoid is necessary for proper reaming and component insertion (Fig. 2). It is recommended to use the delto-pectoral approach since the superio-lateral approach may not provide adequate exposure. If the delto-pectoral approach is chosen, the proximal humerus is retracted posteriorly and inferiorly allowing straight on access to the glenoid.

Tips: If exposure is limited, re-check the humeral osteotomy level and ensure inferior capsular releases were thorough. The long head of the biceps tendon must be excised completely. Also, ensure full deltoid mobilization and removal of humeral osteophytes.

Ensure to preserve glenoid osteophytes as the Signature ONE guide is designed to register off of them. Prepare the anatomy and remove as much soft tissue in and around the glenoid as needed to allow for optimal Signature ONE Guide fit and placement. Specifically, remove the entire capsulolabral complex on the anterior and inferior rim of the glenoid, approximately 11 to 6 o'clock on a left shoulder (Figure 3). Proceed with additional capsule releases surrounding the anterior and inferior rim of the glenoid as necessary. When placed correctly, the guide will fit snug against the face and the anterior rim of the glenoid.



Figure 5

Figure 6

Posterior-Superior directed pressure on the pressure point is ideal. The provided viewing window should be used to ensure the guide is fully seated.

Placing the Signature ONE Pin Guide

The pressure point was designed to help align the guide when direct thumb pressure is applied to this point on the guide (Figure 5). Be sure to provide sufficient superior/posterior directed pressure when

securing the guide to the bone. The anterior viewing window allows a visual check to assure the guide is fully seated (Figure 6 inset).

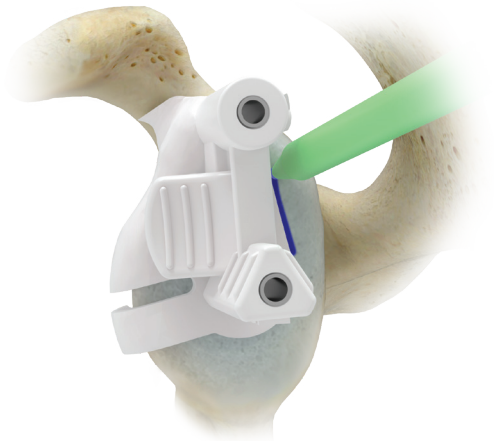

Figure 7

Use of a sterile marking pen can be used to outline the guide on the patient's glenoid.

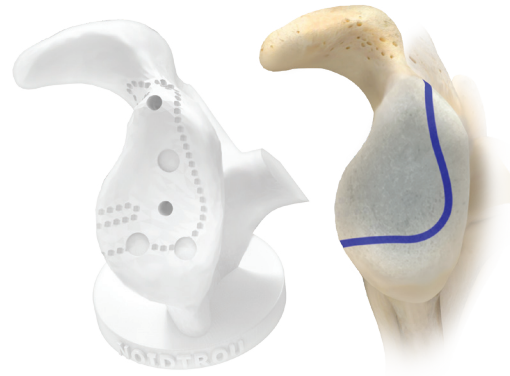

Figure 8

The outline can be used to compare to the bone model registration outline.

A sterile marking pen can be used to outline the glenoid guide intraoperatively and then reference the provided bone model to compare the placement of the guide (Figure 7 and 8). The bone model has the outline of the guide engraved on the surface that can be used as a visual reference.

When placed correctly, the guide will fit snug against the face and the anterior rim of the glenoid.



Figure 9

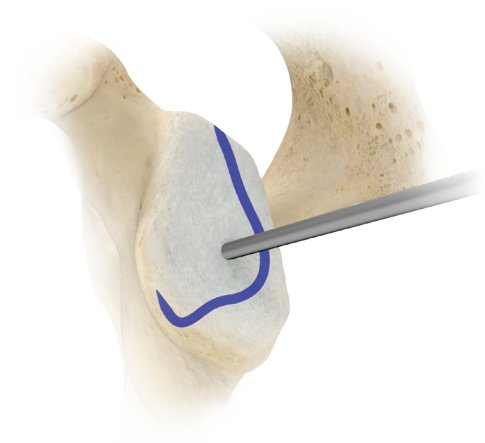

Figure 10

The guide pin should be secure and in the correct location.

Inserting Guide Pins

While securing the guide to the bone, insert the inferior guide pin through the guide and into bone. Ensure the guide pin engages and perforates the medial cortical wall and is stable within bone (Figure 9 and 10). It is imperative that the guide pin be evaluated for accurate placement and orientation. Compare the

inserted pin with the pin location on the bone model. If the guide pin is not sufficiently oriented, please remove and repeat with the guide again ensuring complete registration on the patient's glenoid.



Figure 11

Insert the superior pin if depth, rotational*, and screw orientation* control is desired

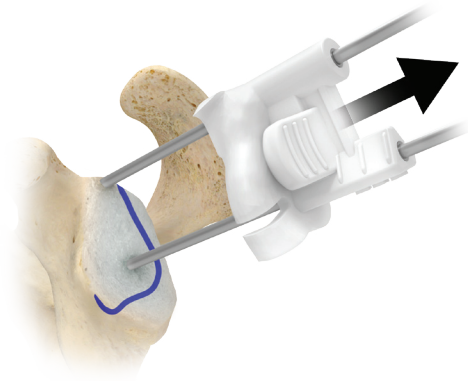

Figure 12

While removing the guide, ensure to remove parallel to the guide pin(s).

If depth control, rotational* control, and screw orientation* control are desired, insert the superior guide pin as well (Figure 11). Compare the superior pin placement with the pin location on the bone model.

Remove the guide from the bone ensuring the direction of travel is parallel with the secured pins. Ensure to leave the pin(s) in place (Figure 12). The pins should be parallel and stable.

*Rotation and screw orientation control is only available with the Zimmer Biomet TMR+ implant system

ⓘ **Note:** The Signature ONE Pin Guides utilize a 3.2mm Steinman pin when used with a Comprehensive Implant System and use 2.5mm pins when used with the TMR+ system.

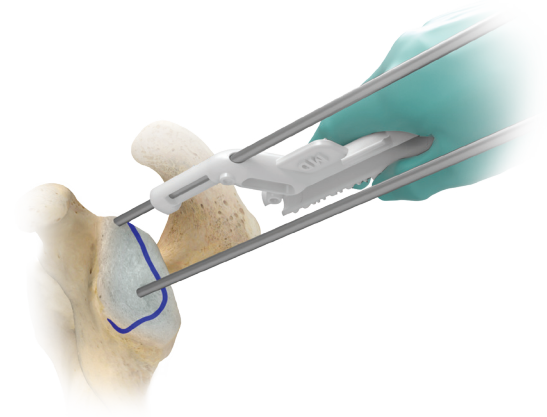

Figure 13

First, slide the Signature ONE Reamer guide over the superior pin.

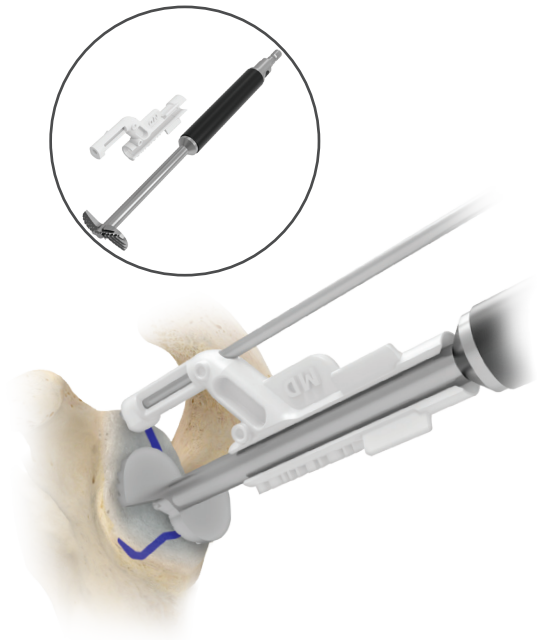

Figure 14

After inserting the reamer over the inferior pin, assemble the Signature ONE reamer guide to the reamer shaft. The guide will snap into place.

Glenoid Preparation

If only position, version, and inclination control is desired, please proceed to the following techniques for glenoid preparation and implant insertion. For depth control or screw orientation (TMR+ only), please see the proceeding steps of this surgical technique.

- Comprehensive Reverse Technique 0173.1
- Comprehensive Augmented Baseplate Technique 0468.1
- Comprehensive Modular Hybrid Glenoid Technique 1271.1
- TMR+ Shoulder System 1423.1

Glenoid Preparation–Comprehensive Anatomic, Reverse, and Augmented Baseplate Procedures

(for Zimmer Biomet TMR+, skip to page 15)

Slide the Signature ONE reamer guide over the superior pin (Figure 13). While the Signature ONE reamer guide is captured by the superior pin, slide the Comprehensive anatomic fossa reamer or glenoid mini baseplate reamer over the inferior pin depending on the procedure being performed. With the reamer captured by the inferior pin, rotate the Signature ONE reamer guide such that it engages and clips over the shaft of the reamer (Figure 14).

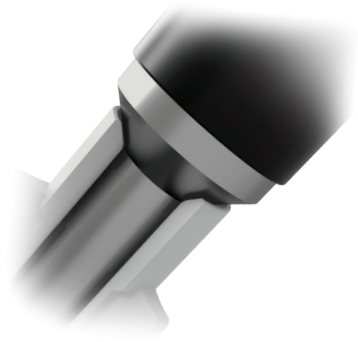

Figure 15

Ream until the lateral portion of the Signature ONE reamer guide contacts the reamer collar.

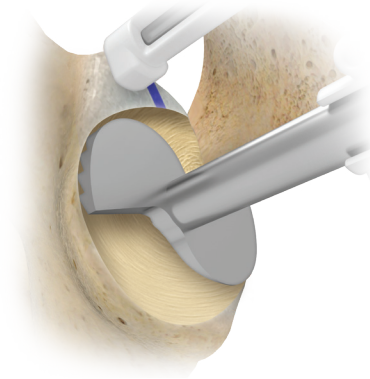

Figure 16

Ensure that the Signature ONE Reamer guide has completely contacted bone and not soft tissue.

Warning: When using the Signature ONE reamer guide with the Comprehensive Reverse Mini baseplate, the system is only compatible with item 110029136 (9.0 inches). The system is not compatible with item 405807 (10.4 inches).

Hold the reamer assembly parallel to the superior pin and ream until the Signature ONE reamer guide reaches the lateral end of the reamer shaft (Figure 15), ensuring that the medial end of the Signature ONE reamer guide contacts the bone surface (Figure 16) and there is no soft tissue between the guide and the bony surface.

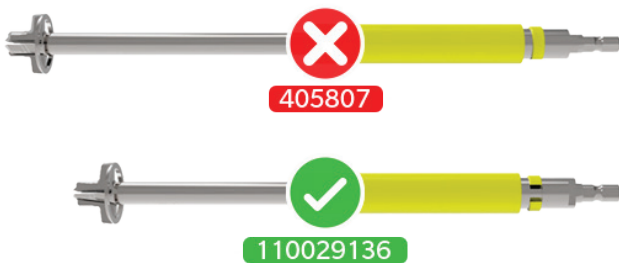



Figure 17
Remove the guide by utilizing the two tabs

Lift the reamer assembly from the glenoid leaving pins in place taking care not to change the angle of the pins. The Signature ONE reamer guide is still attached to the reamer shaft. Confirm that the ream surface matches the preoperative plan (see picture provided in the Surgical Planning report). Unclip the Signature ONE reamer guide from the shaft of the reamer by pushing on the two tabs on the shaft to unsnap the Guide (Figure 17).

There are no additional Signature ONE guide steps for the Comprehensive Reverse Baseplate, Comprehensive Reverse Augmented Baseplate, and Comprehensive Anatomic procedures. The remainder of the procedure will follow the traditional techniques listed below.

- Comprehensive Reverse Technique 0173.1
- Comprehensive Augmented Baseplate Technique 0468.1
- Comprehensive Modular Hybrid glenoid Technique 1271.1

☰ **Note:** The provided Signature ONE bone model can be used as a visual aid to help with implant rotation as compared to the pre-operative plan. The Signature ONE bone model includes the following:

- **Comprehensive Anatomic Procedures:** The bone model has indentations detailing the location of the peripheral pegs for the Comprehensive Modular Hybrid Glenoid (See Bone Model Features and Text, pg. 5)
- **Comprehensive Reverse Procedures:** The bone model has an orientation line indicating the alignment of the inferior and superior screw holes for the Comprehensive Mini Baseplate (See Bone Model Features and Text, pg. 5)
- **Comprehensive Reverse Augmented Procedures:** The bone model includes the augment orientation line and the location of the anti-rotation augment preparation hole for the Comprehensive Augmented Baseplate (See Bone Model Features and Text, pg. 5).

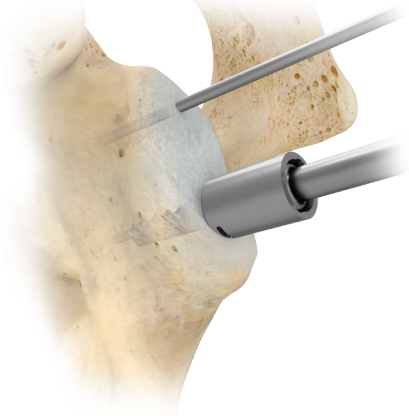

Figure 18

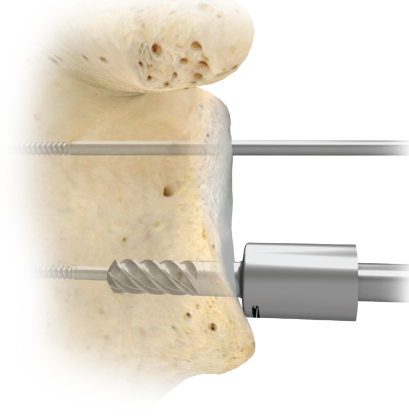

Figure 19

In case of steep inclination and version angle, drill shoulder may not fully contact glenoid surface. In such cases, redrill after reaming.

Glenoid Preparation – Zimmer Biomet TMR+™ Shoulder System

To create a pilot hole for the glenoid reamers, a 6 mm Cannulated Drill is needed. The 6 mm Cannulated Drill comes in 15 mm, 20 mm, 25 mm and 30 mm lengths. Use the 6 mm Cannulated Drill with length that corresponds to the center post length of the intended base plate (see Surgical Planning Report for planned post length). The length is etched on the Drill collar to distinguish size. The 6 mm Cannulated Drill attaches to the Cannulated Straight Driver by sliding the Driver tabs into rounded slots of the 6 mm Cannulated Drill. Turn the Cannulated Straight Driver 90° clockwise to retain the 6 mm Cannulated Drill. Place the Cannulated Drill assembly over the 2.5 mm Pin and drill until the housing collar is flush to the glenoid face (Figure 18). Do not over penetrate the glenoid face, and be careful to keep Pins parallel when drilling.

Try to drill to the necessary depth and remove the drill without stopping the drill. This will usually leave the 2.5mm inferior pin in place. If the inferior pin is loose after drilling, remove it.

ⓘ **Note:** In the event of a steep inclination and version angle, the 6mm Cannulated Drill may not contact the glenoid surface (Figure 19). If such a situation is suspected, redrill with the 6mm Cannulated Drill after complete surface reaming to ensure drilling is complete.

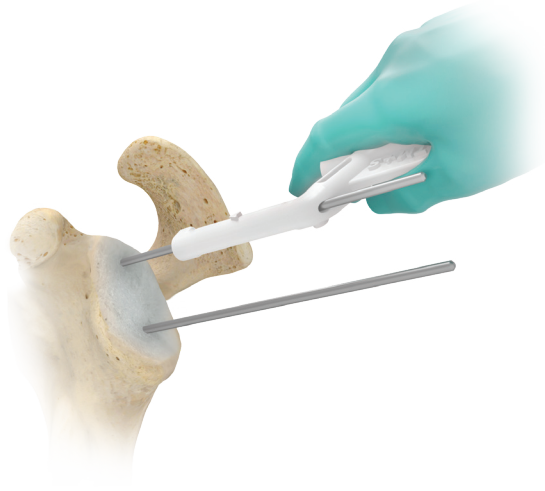

Figure 20

First, slide the Signature One reamer guide over the superior pin.

Optional: Use of single use; Tecomet reamer

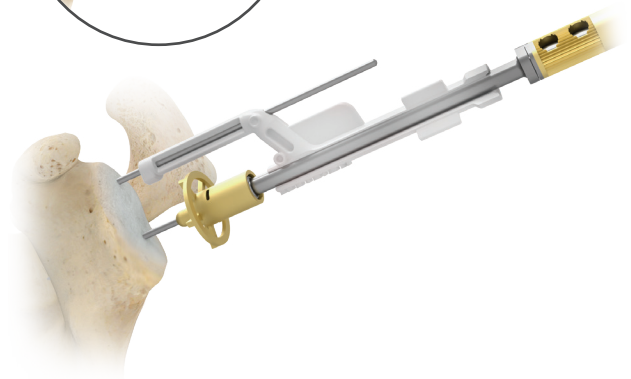
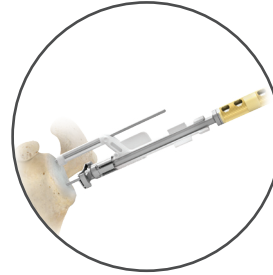

Figure 21

After inserting the reamer over the inferior pin, assemble the Signature ONE reamer guide to the reamer shaft. The guide will snap into place

Slide the Signature ONE reamer guide over the superior pin (Figure 20). While the Signature ONE reamer guide is captured by the superior pin, slide the *TMR+ baseplate reamer over the inferior pin. With the reamer captured by the inferior pin, rotate the Signature ONE reamer guide such that it engages and clips over the shaft of the reamer (Figure 21).

ⓘ ***Note:** Please see the TMR+ Shoulder System Baseplate and Glenosphere surgical technique (1423.1-US) for additional details on the reamer options and usage. This can be found within the “Ream Glenoid Bone and Prepare Center Hole” section.

Optional: Use of single use; Tecomet reamer

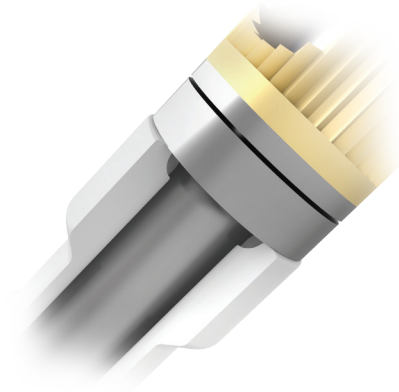

Figure 22

Ream until the lateral portion of the Signature ONE reamer guide contacts the reamer collar.

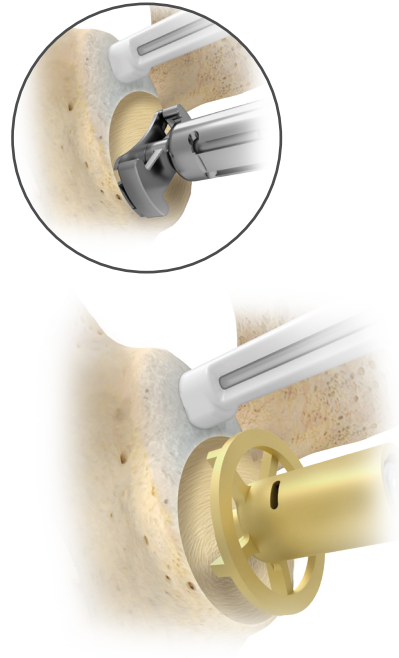

Figure 23

Ensure that the Signature ONE reamer guide has completely contacted bone and not soft tissue.

Warning: You must use the reamer option chosen during pre-operative planning. This could either be the single use reamers (Tecomet reamer) or the reusable reamers (gold coated). The selected option is marked on the reamer guide (TM+S for single use and TM+R for reusable) and is shown in the Surgical Planning Report.

Hand ream until the Signature ONE reamer guide reaches the lateral end of the reamer shaft (Figure 22), ensuring that the medial end of the Signature ONE reamer guide contacts the bone surface (Figure 23).

WARNING: This is a sharp reamer and power reaming may remove excessive bone. Do not use excessive force when reaming the bone as this may cause the instrument to bend or fracture.



Figure 24
Remove the guide by utilizing the two tabs

Lift the reamer assembly from the glenoid leaving pins in place taking care not to change the angle of the pins. The Signature ONE reamer guide is still attached to the reamer shaft. Confirm that the reamed surface matches the preoperative plan (See picture provided in the Surgical Planning Report). Unclip the Signature ONE reamer guide from the shaft of the reamer by pushing on the two tabs on the shaft to unsnap the Guide (Figure 24).

Depending on the size (36 mm or 40 mm) and eccentricity option (centric or eccentric) of glenosphere that will be implanted, select the corresponding Cannulated Base Plate Reamer 2. Refer to the Surgical Planning Report to see the option selected during pre-operative plan. Rotate the Ratchet T Handle collar to the centered, locked position. Attach the chosen bow-tie shaped Cannulated Base Plate Reamer 2 to the Cannulated Straight Driver assembly. Ream by hand, using an oscillating motion, until the spokes are flush to the previously reamed face. The outer

cutting teeth of Cannulated Base Plate Reamer 2 will ream the surrounding bone to provide clearance for the glenosphere head. Once the base plate implant is in place, surface reaming is not possible. In the event that Cannulated Base Plate Reamer 2 will not fit through the tissue envelope, the alternatives include use of a rongeur or burr to clear any peripheral bone which may inhibit full seating of the glenosphere.

Note: This step is necessary to help ensure the glenosphere head will lock on the Base Plate properly. All reasonable efforts should be made to use the appropriate Base Plate Reamer 2. The size of base plate reamer corresponds to the glenosphere head to be used.

Lift the Cannulated Reamer 2 assembly from the glenoid leaving the pins in place taking care not to change the angle of the superior Pin. Remove the inferior pin from the glenoid bone.

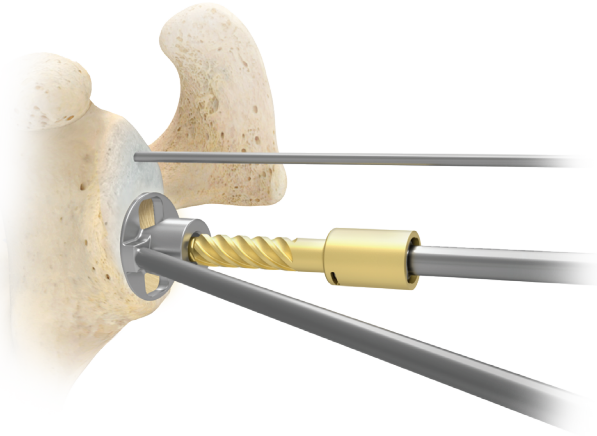

Figure 25
Use of the Base Plate Drill Guide 2

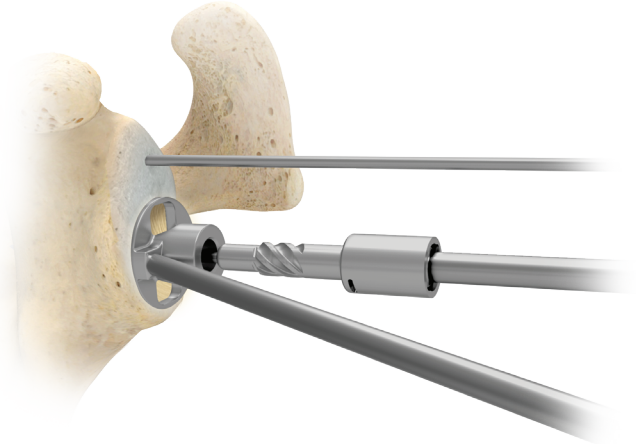

Figure 26
Use of Cortex Drill

Drill Base Plate Post Hole for TMR+ Shoulder System

- ⓘ **Note:** No Signature ONE Guide is required for this step. Use the appropriate length of the 7.5mm Drill determined by the pre-operative plan. Do not use the Signature ONE Ream Guide.
- ⓘ **Note:** When using Base Plate Reamer 2 for eccentric Glenospheres, one side of the cutting blade is longer than the other to accommodate for the eccentricity. It is important to orient the longer blade (marked on the instrument by “Offset”) toward the intended glenosphere offset direction. Oscillating motion during reaming is advised to minimize the extent of bone reamed.

The final glenoid preparation step is to enlarge the center post hole using a 7.5 mm Cannulated drill, which is available in lengths of 15 mm, 20 mm, 25 mm and 30 mm. Choose the appropriate drill length based on bone quality and surgeon preference. The drill length used will regulate the center post length of the base plate implant. These drills must be used with the Base Plate Drill Guide 2 to avoid drilling too far medially and to position straight on to the glenoid reamed surface (Figure 25).

Poor Bone Stock

When implanting a 15 mm Base Plate into poor bone stock, the instrument set provides three drill types: A 7.5 mm Drill, a 7.5 mm Cortex Drill, or a 7.5 mm Compression Plug. Use the 7.5 mm Cortex Drill with Drill Guide 2 (Figure 26) to remove only the first 3 to 4 mm of glenoid cortex. If a press fit of the distal end of the Base Plate post is desired, then the preparation is complete. If it is deemed appropriate to compress more bone, use the 7.5mm Compression Plug with Drill Guide 2 to compress the cancellous bone in the vault prior to implant insertion. There are no 20 mm, 25 mm and 30 mm versions of the Cortex Drill or Compression Plug. Marked bone loss is contraindicated.

- ⓘ **Note:** The Compression Plug should not be used unless the 7.5 mm Cortex Drill is used first. Otherwise there may be a risk of glenoid fracture.
- ⓘ **Note:** A small drill can be used to sound for confirming good bone quality. If the Signature ONE screw guide is not utilized, drill guide 2 has two reference marks to help aid in the superior/inferior placement of the Inverse/Reverse Screws. You may choose to make anatomical marks for the placement of the Inverse/Reverse Screws.

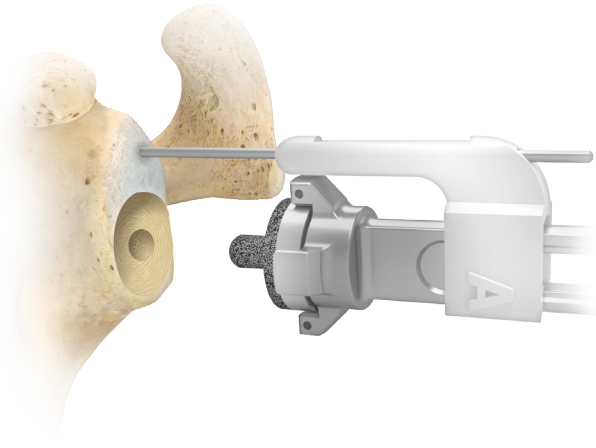

Figure 27

Clip the Signature ONE Impactor Guide to shaft of the Base Plate Inserter assembly and engage the superior guide pin into the hole of the Signature ONE Impactor Guide.

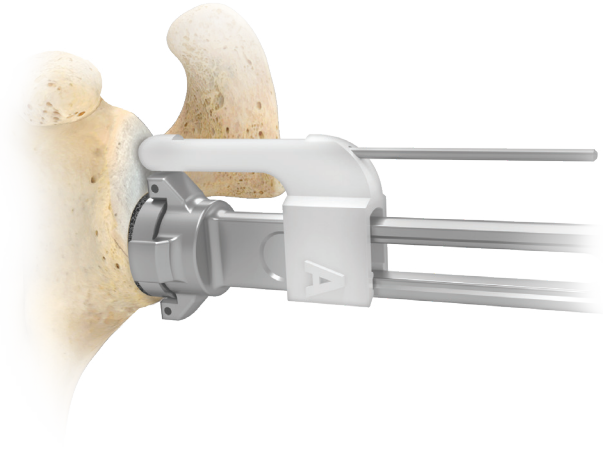

Figure 28

Insert the Base Plate/Base Plate Inserter assembly into the prepared glenoid. The Impactor Guide should contact the bone over the superior pin.

Base Plate Insertion TMR+ Shoulder System

Note: Bone cement should not be used to secure the base plate to the glenoid bone. Initial base plate fixation will come from 0.5 mm interference fit along the center post and superior/inferior compression screw fixation.

Prior to implantation, confirm the base plate post size. The base plate center post length comes in four sizes (15, 20, 25 and 30mm), and the final implant size must match the length of 6mm Cannulated Drill and 7.5mm Drill used to prepare the glenoid vault.

Clip the Impactor Guide to the shaft of the Base Plate Inserter. Attach the definitive Base Plate implant to the Base Plate Inserter. Verify the side marked “A” is positioned anterior and the side marked “P” is positioned posterior, then insert the Base Plate/Base Plate Inserter assembly into the prepared glenoid and achieve the intended baseplate rotation (roll) orientation by engaging the superior guide pin into the hole of the Impactor Guide (Figures 27 and 28).

The Impactor Guide should be slid down on the Base Plate Inserter up to the level illustrated in Figure 27. Ensure not to slide it lower than this level.

The Base Plate is implanted by striking the Base Plate Inserter with a mallet until the back of the component is completely flush with the prepared surface. Once again take care to slide the Signature ONE Impactor Guide in line with the reference Pin. A tendency to drop the hand will not allow the Impactor Guide to properly place the Base Plate at its proper position with respect to tilt and version.

Disengage the Base Plate Inserter and Impactor Guide from the fully seated Base Plate implant. Make sure to visualize full seating thru the screw holes of the Base Plate and reengage the Impactor Guide if necessary for further seating.



Figure 29
Insert the Signature ONE Screw Guide into the cavity of the base plate. Ensure guide protrusions mate with screw holes on the base plate and guide arrow is positioned superiorly.



Figure 30
Visually verify that the arrow on the Signature ONE Screw Guide points to the superior pin



Figure 31
Drill the screw pilot holes bi-cortically through the Signature ONE Screw Guide and Base Plate.

Drill Screw Holes and Insert Screws and Locking Caps for TMR+ Shoulder System

Insert the Screw Guide onto the base plate making sure to mate the hole of the Screw Guide with the male taper of the base plate. Ensure that the arrow on the Screw Guide is positioned superiorly (Fig. 29) and points to the superior pin (Fig. 30). This confirms the base plate screw holes are oriented according to the pre-operative plan.

Note: If the arrow does not point to the superior Pin, the Screw Guide should not be used and the Trabecular Metal™ Reverse Drill Guide should be used instead in the standard non-patient specific instrument fashion.

Remove the Superior Pin from the glenoid. Attach the 2.5mm Drill to power. Hold the Screw Guide by hand using your index finger while inserting the Drill. Drill the screw pilot holes bi-cortically through the Screw

Guide and Base Plate (Fig. 31). A drill push technique is useful to palpate for the second cortex in this relatively thin walled area of the scapula. Lines on the 2.5mm Drill should not be used to measure the screw length as the height of the Screw Guide will affect the reading.

WARNING: When drilling the screw holes, care should be taken to avoid bending the 2.5mm Drill when it is inside the Screw Guide. This creates resistance between the Drill and screw Guide which may cause the drill to fracture. Ensure that the Drill is engaged in the orientation planned by the Guide to avoid bending the 2.5mm Drill.

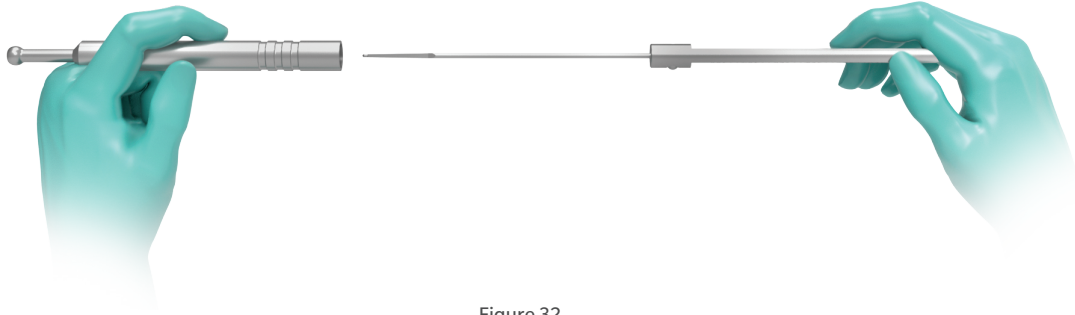

Figure 32
Assemble the Depth Gauge and insert into screw holes to validate proper screw length.



Figure 33
Affix locking cap to the Reverse Torque Wrench and gently slide the Locking Screw Holder over the locking cap. The flat surface of the locking cap must point towards the screw.

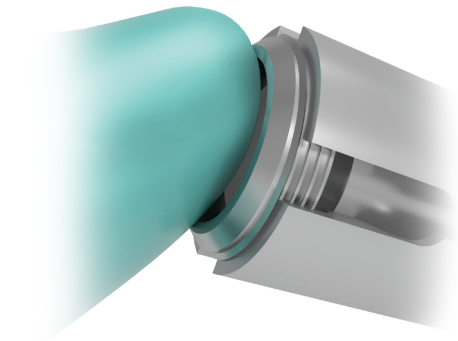

Figure 34
The flat surface of locking cap must point towards the screw.

Remove the 2.5mm Drill and Signature ONE Screw Guide. Assemble the Screw Depth Guide (Fig. 32) and insert into the screw holes to confirm screw length. The planned screw length appears on the pre-operative plan. Note that the depth gauge reading may not be the identical value as the planned screw length, due to planned screw tip perforation. Screws are available in 18-48mm lengths. Remove the superior 2.5mm Guide Pin from the base of the coracoid process. Attach the screw to the Hexagonal Screw Driver, making sure good bone purchase is achieved.

Note: To avoid rotation of the baseplate while torquing the screw, thread the first screw without torquing it down completely. Engage the other screw and fully torque it, before returning to the first screw and torquing it down completely as well. To rigidly lock the screw in place, affix a locking cap to

the Reverse Torque Wrench with convex side facing lateral, and gently slide the Locking Screw Holder over the locking cap (Fig. 33). The locking cap and Reverse Torque Screwdriver should be orientated perpendicular to the base plate surface. Turn the Locking Cap in place until the Torque Screwdriver slips or an audible click is heard.

Note: The locking cap only engages in one orientation. The concave surface must be pointing toward the screw (Fig. 34). To avoid mis-threading, the screwdriver shaft should be perpendicular to the base plate to properly seat the locking screw. Failure to slide back the Locking Screw Holder can impede locking cap insertion.

ⓘ **Note:** While engaging the locking cap on the baseplate with the Locking Screw Holder, orient one of the slots on the Locking Screw Holder towards the baseplate taper. This will avoid interference with the baseplate taper, in case the Locking Screw Holder expands during locking cap tightening.

There are no additional Signature ONE Guide steps and the remainder of the procedure will follow the traditional, technique listed below.

- TMR+ Glenoid Surgical Technique 1423.1

For indications, contraindications, warnings, precautions, potential adverse effects and patient counselling information, see the package insert or contact your local representative; visit www.zimmerbiomet.com for additional product information. Check for country product clearances and reference product specific instructions for use.

Zimmer Biomet does not practice medicine. This technique was developed in conjunction with health care professionals. This document is intended for surgeons and is not intended for laypersons. Each surgeon should exercise his or her own independent judgment in the diagnosis and treatment of an individual patient, and this information does not purport to replace the comprehensive training surgeons have received. As with all surgical procedures, the technique used in each case will depend on the surgeon's medical judgment as the best treatment for each patient. Results will vary based on health, weight, activity and other variables. Not all patients are candidates for this product and/or procedure. Caution: Federal (USA) law restricts this device to sale by or on the order of a surgeon. Rx only.

©2020 Zimmer Biomet



Authorized Representative

Zimmer U.K. Ltd.
9 Lancaster Place
South Marston Park
Swindon, SN3 4FP, UK



ZIMMER BIOMET

Your progress. Our promise.®



Legal Manufacturer

Zimmer CAS
75 Queen Street, Suite 3300
Montreal, Quebec
Canada, H3C 2N6
Phone: (514) 395-8883

www.zimmerbiomet.com

CE 0413

CE mark on a surgical technique is not valid unless there is a CE mark on the product label.

2532.2-GLBL-en-REV0420