

The image displays several components of the FastFrame External Fixation System. These include teal-colored cylindrical shafts, black metal brackets with multiple circular holes, and black circular end caps with textured surfaces. Red plastic caps and levers are attached to the shafts and brackets, with some labeled "REMOVE TO ENGAGE LOCK". The shafts feature the "FastFrame DAMAGE CONTROL" logo and a circular icon with a stylized 'Z'. Technical markings on the shafts include "STERILIZED", "2 MR", and "47-5300-030-00".

FastFrame™ External Fixation System

Damage Control Surgical Technique



ZIMMER BIOMET
Your progress. Our promise.®

Table of Contents

Introduction	2
Indications and Contradictions	3
First and Second Pin Placement	4
Post Second Pin Placement	7
Drill Third and Fourth Pins Through Frame	8
Lock Clamps Over Pins	9
Reduce and Pull Red Tabs	9
Final Frame Locking	10
Postoperative Management	10
Implant Removal	11
MRI Safety Information - MR Conditional	12
Ordering Information	13

Introduction

- 1 Clamp to Pin Lockout Wing Nut
- 2 Polyaxial Lockout Wing Nut
- 3 Polyaxial Lockout Bolt
- 4 Telescoping Lockout Clamp
- 5 Lockout Tab
- 6 Telescoping Lockout Bolt
- 7 Clamp Slider
- 8 Backup Telescoping Lockout Bolt

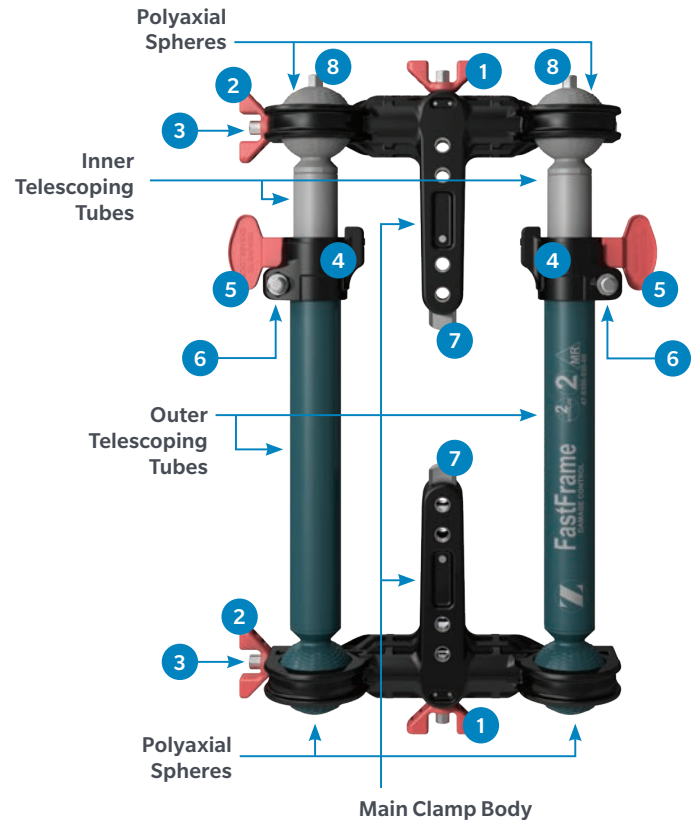

Figure 1

The FastFrame External Fixation System – Damage Control is a single-use external fixator consisting of the following components that are manipulated by the end user: clamps, telescoping rods, and half-pin bone screws (Figure 1). This system comes sterile packed in its fully assembled state and does not require any intraoperative assembly by the physicians.

The main clamp bodies will be interconnected to each other with adjustable (telescoping) tubes that allow the clamps to rotate, pivot, and translate with respect to the long axis of the bone. This will allow the clamps to properly reduce the fracture and subsequently rigidly fix the bones in place.

The telescoping tubes result in a total range of accommodated pin placement of 265 mm. The fully collapsed frame is 75 mm long (from the innermost pin location of one clamp to the innermost pin location of the opposing clamp) while the fully extended frame is 340 mm long from outermost pin location of one clamp to outermost pin location of opposing clamp (Figure 2). This length adjustment allows for proper fit on a wide variety of patient sizes.



Available Pin Placement Range of the Frame

Figure 2

INDICATIONS

The FastFrame External Fixation System - Damage Control is indicated for use in treatment of mid-shaft long bone (femur, tibia) fractures. Specifically, the system is intended for:

- Stabilization of open or closed fractures of the femur and tibia, typically in the context of polytrauma or where open or alternative closed treatment is undesirable or otherwise contraindicated;
- Stabilization of non-unions; and
- Intraoperative temporary stabilization to assist with indirect reduction.

CONTRAINDICATIONS

- Active or suspected infection
- Conditions that limit the patient's ability and/or willingness to follow instructions during the healing process.
- Inadequate skin, bone, or neurovascular status

Contraindications may be relative or absolute and are left to the discretion of the surgeon.

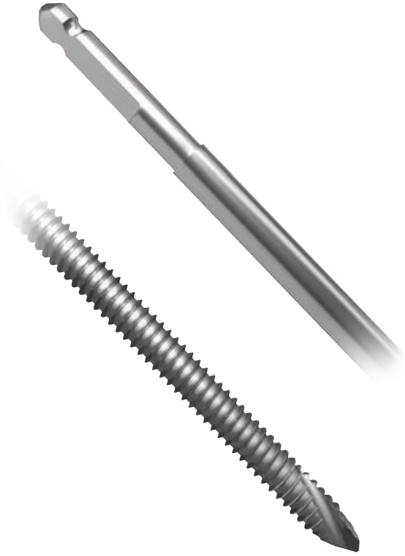

Figure 3

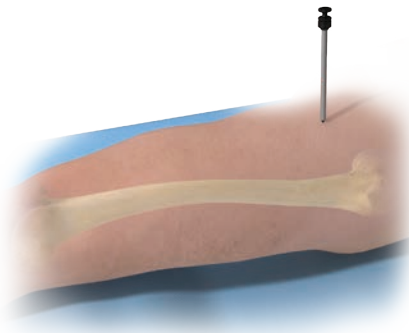

Figure 4

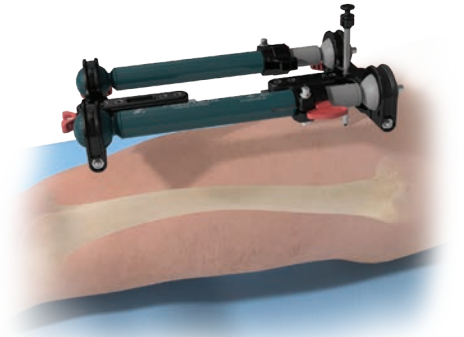

Figure 5

First and Second Pin Placement

The FastFrame™ External Fixation System – Damage Control comes equipped with four (4) self-drilling, self-tapping 5 mm X 200 mm X 65 mm thread pins. Each pin has an AO quick connect feature that connects to most power equipment (Figure 3).

Trocar and tissue sleeve can be used through the frame or independently (Figure 4).

To place the first pin, insert the tissue sleeve and trocar through the desired pin hole on either proximal or distal clamps (Figure 5).

Note: It is important to assess the distance between the fracture site and your pin placements to optimize frame expansion and minimize risk of infection.

Using the trocar, make a mark on the skin for the incision. After the mark has been made, make the incision, and gain access to the bone using the tissue sleeve and trocar to transect the soft tissues.

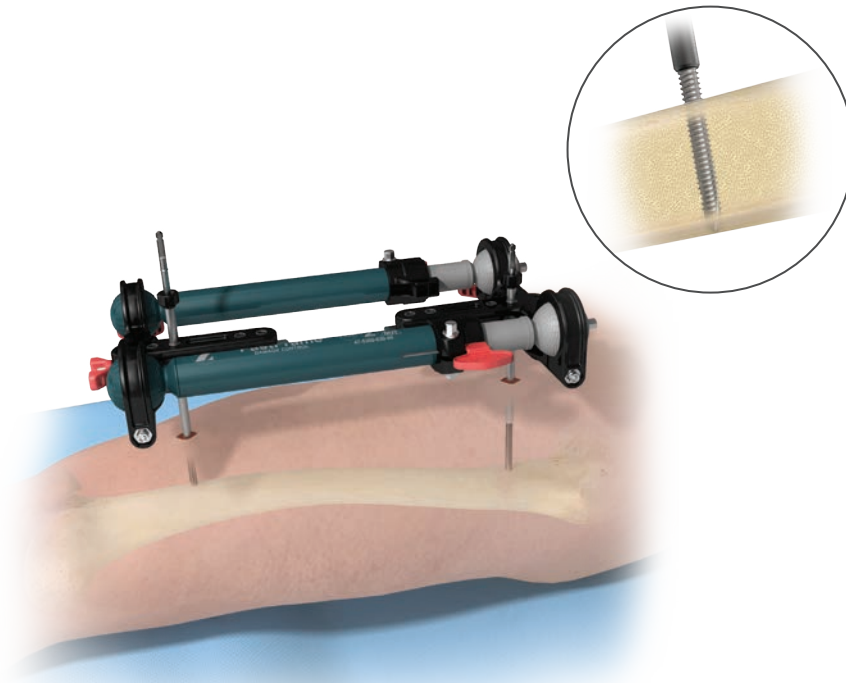

Figure 6

Remove the trocar from the tissue sleeve and insert the first pin through the tissue sleeve. Drill the pin into the bone deep enough to provide cortical fixation (Figure 6). Repeat for the second pin which should be placed in the opposing clamp, or bone if drilling independently of the clamp. Drilling beyond the far cortex is not recommended, as this will place soft tissues at risk.

⚠ **Warning:** Uni-cortical fixation does not provide adequate fixation.



Figure 7



Figure 8

First And Second Pin Placement (cont.)

The FastFrame External Fixation System - Damage Control Frame accommodates pin placements from 75 mm to 340 mm. Ensure that the first and second pins allow for subsequent frame expansion and reduction. It is important to note there are four options for pin placement in both proximal and distal clamps (Figure 7).

- ⓘ **Note:** Do not tighten the clamp slider bolt until all four (4) pins have been drilled and the frame has been applied (Figure 8).



Figure 9

First and Second Pin Placement (cont.)

The FastFrame External Fixation System comes packaged with the telescoping bars positioned slightly anterior to the clamp when viewing from a lateral position. The position in which frame is packed is considered its standard orientation. The frame is designed in order to achieve greater spacing between the frame and the patient's anatomy (Figure 9). The FastFrame can also be applied in a "reverse" position by inverting the frame and placing the bars closer to the patient's anatomy. After inverting the frame, the outer telescoping tubes can be rotated in order to make the telescoping locking bolts more accessible for tightening.

Post Second Pin Placement

When placing the frame over the first and second pins, choose pin holes on clamps such that there is adequate bone for placement of subsequent pins. Third and fourth pin placement should be chosen irrespective of fracture type. Place frame over both pins if drilling occurred independent of the frame. Pins can be placed through any of the four clamp holes of each clamp. The pin holes on each clamp allow for a paradigm of pin placements, thus it is important to gauge the distance between the final pin placement and the fracture. Determine if frame is in accurate location and verify pin spacing with respect to minimum and maximum lengths.

Note: Do not lock frame onto pins at this stage.

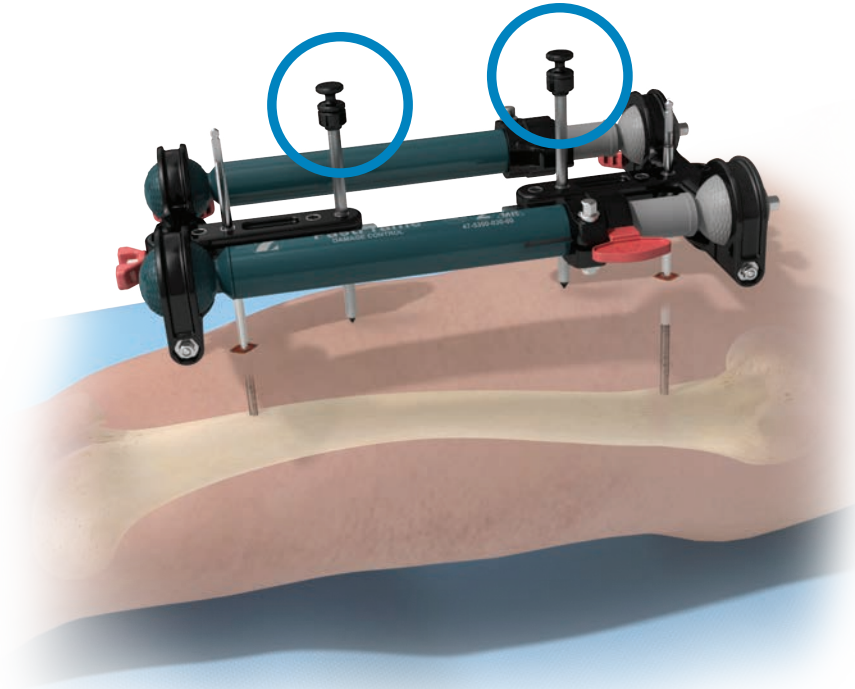

Figure 10

Post Second Pin Placement (cont.)

Once the appropriate pin holes are chosen and the frame is over both the first and second pins, place the tissue sleeve and trocar for the third and fourth pin holes (one in each clamp) (Figure 10). Using the trocar, make a mark on the skin for the incision. After the mark has been made, make the incision, and gain access to the bone using the tissue sleeve and trocar to transect the soft tissues.

Drill Third and Fourth Pins Through Frame

Remove the trocar from the tissue sleeve and insert the third pin through the tissue sleeve. Drill the pin into the bone deep enough to provide bi-cortical fixation. Repeat for the final pin.

Drilling beyond the far cortex is not recommended, as this will place soft tissues at risk.

⚠ Warning: Uni-cortical fixation does not provide adequate fixation.



Figure 11

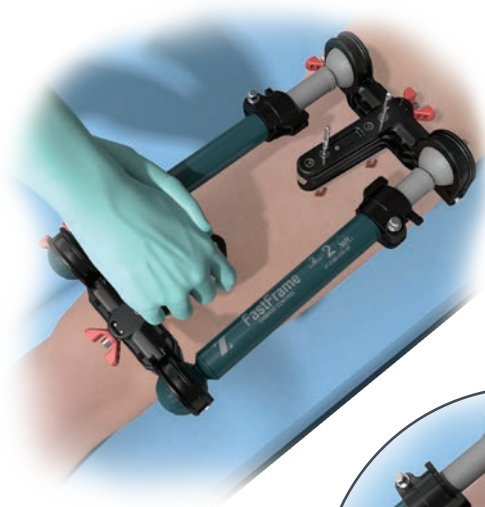

Figure 12

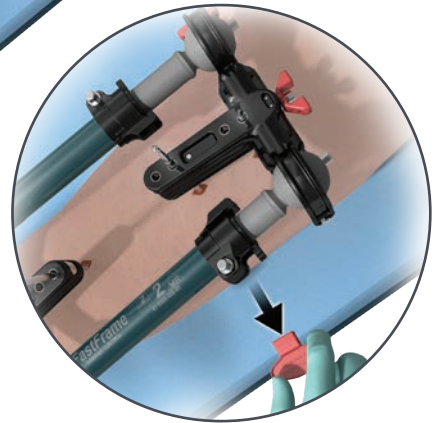

Figure 12a

Lock Clamps Over Pins

When all four pins are in place, provisionally tighten the clamp over the pins by hand using the wing nut on the clamp slider bolt (Figure 11).

Reduce and Pull Red Tabs

In its current state, the frame can freely expand and contract. Achieve the initial stabilization by holding the frame around the clamps and pulling until desired reduction is achieved (Figure 12). The clamps can be used to grip the frame while extending the frame to achieve the intended reduction. Removing the red lockout tabs enables the traction retention capability of the frame.

The frame will be locked into the selected length, and will not contract in size (uni-directional) once the red lockout tabs are removed (Figure 12a).

ⓘ **Note:** Red tabs can be re-inserted to regain free expansion and contraction of the frame.

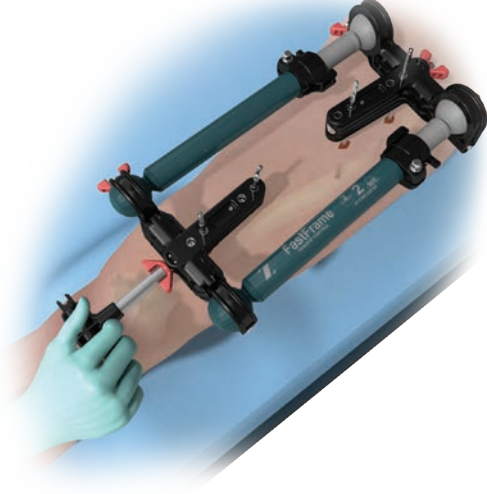

Figure 13

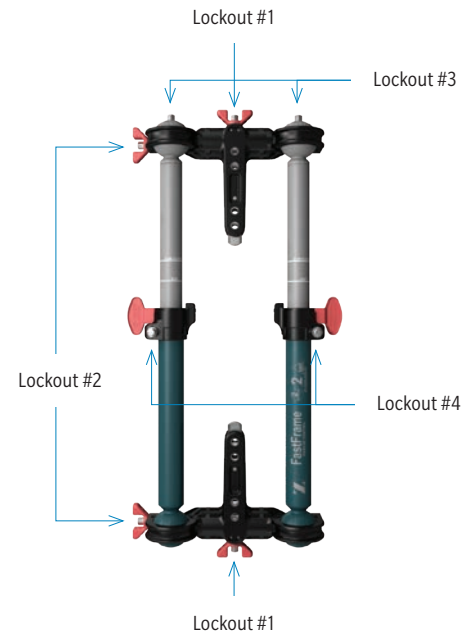

Figure 14

Final Frame Locking

Utilize the T-handle driver to conduct final frame locking (Figure 13). Note the 1 – 4 number sequence on each nut and tighten the nuts in this order (Figure 14).

1. Tighten the clamp slider bolts on each clamp (indicated as Lockout #1 in Figure 14) in order to fix the clamps to the pins.
2. Tighten the polyaxial lockout bolts on each clamp (indicated as Lockout #2 in Figure 14) in order to fix the clamps to the bars.
3. Lock the two backup telescoping lockout bolts (indicated as Lockout #3 in Figure 14) to allow initial fastening of the telescoping bars.
4. Lock the two telescoping lockout bolts along the tube/bars near the red tabs (indicated as Lockout #4 in Figure 14) to allow complete fixation of the telescoping bars.

Postoperative Management

Pin Care

Using dry gauze dressings, wrap each pin site to ensure blood is absorbed and swelling is reduced. Once the site is dry, it is best left open. Pin tract care varies per doctor or nurse. It is important to keep the site clean through washings and respective maintenance. Pin tract infections are noticeable through pain, discharge of pus, or swelling. Please address immediately if these signs are noticeable.

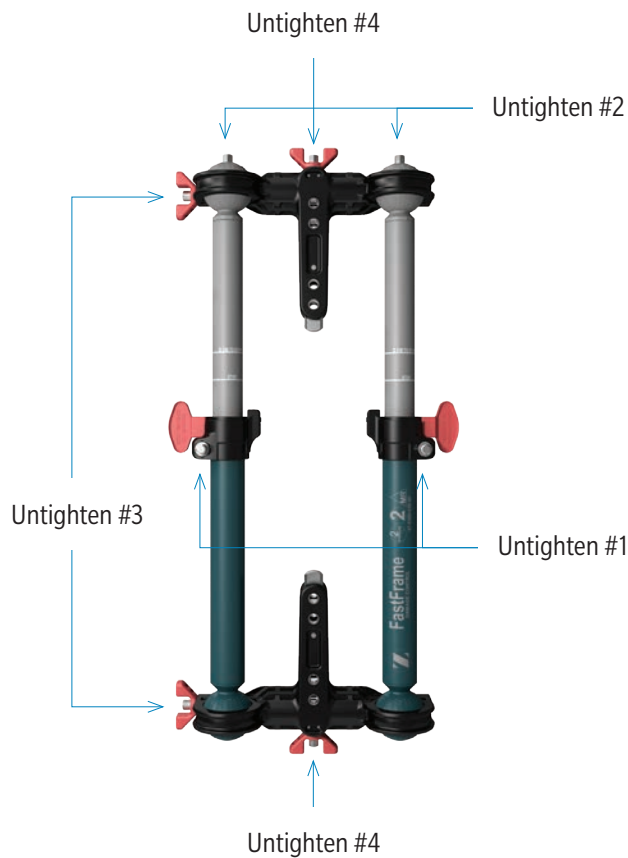

Figure 15

Implant Removal

For the removal of the FastFrame External Fixation System – Damage Control loosen all bolts identified by numbers Untighten#1-4 manually, or by using the driver (Figure 15).

By untightening all of the bolts, the frame becomes dislodged from its final construct state. Its important to loosen the two clamp slider bolts last. This prevents the frame from sliding down towards the patient and allows for an easier removal of the system.

Note: When loosening the number 3 bolt, ensure to loosen it fully as this unlocks the internal mechanism. (Minimum 3 full rotations)

Once the system is removed, you may dispose of it entirely.

Pin removal can be performed with a manual or power driver that is attached to the standard AO Quick Connect Feature or the shaft of the pin.

MRI Safety Information - MR Conditional

MR Conditional

Non-clinical testing has demonstrated the FastFrame External Fixation System – Damage Control is MR Conditional. A patient with this device can be safely scanned in an MR system under the following conditions:

- Static magnetic field of 1.5 or 3-Tesla
- Spatial gradient magnetic field of 2,000-gauss/cm (2.0-T/m) or less
- Maximum whole body averaged specific absorption rate (WB SAR) of 2.0-W/kg for 15 minutes of scanning
- Normal Operating Mode of operation for the MR system
- Under the scan conditions defined above, the FastFrame External Fixation System – Damage Control is expected to produce a maximum temperature rise of less than 2°C after 15-minutes of continuous scanning with this device positioned completely outside of the scanner bore to ensure patient safety.

Important: The FastFrame External Fixation System – Damage Control must be entirely outside of the bore of the MR system (i.e., outside of the transmit/receive RF body coil). (Refer to the figure below)

Warnings



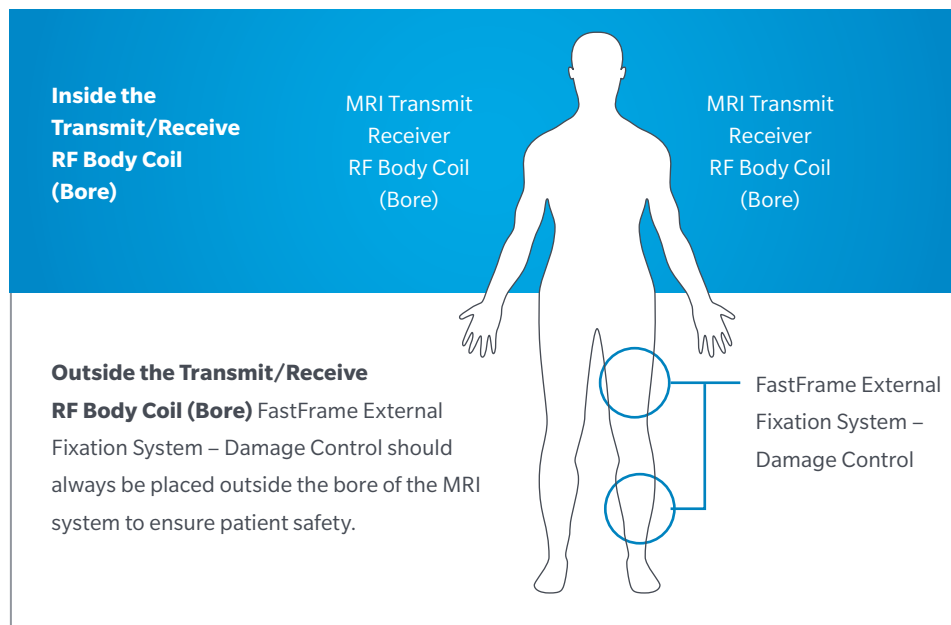

- Using MRI in patients with the FastFrame External Fixation System – Damage Control components can only be performed under these specific conditions. Importantly, it is not allowed to scan a patient with the FastFrame External Fixation System – Damage Control components directly inside the Transmit/Receive RF Coil (Bore). Using other parameters may result in severe implant heating, MRI could result in serious injury to the patient.
- Close patient monitoring and communication with the patient during the MRI examination is required. Immediately stop the MRI examination if the patient reports heating, pain, or any unusual sensation.
- Ensure that the patient's arms and legs do not touch each other or the scanner during the scan sequence.
- Ensure that the fixator frame (aside from the pins) does not touch the patient's body during the scan sequence.

Artifact Information

The largest image artifact extends approximately 35-mm from the device when scanned using a gradient echo (GRE) pulse sequence in a 3-Tesla MR system.



FastFrame External Fixation System - Damage Control (DCO)

Product	Description	Quantity per kit	Part Number
	Damage Control Frame	1	47-5300-030-00
	Pin, Damage Control 5 mm x 200 mm x 65 mm Thread	4	—
	T-Handle Driver 9/32 Hex	1	00-5300-050-01
	Tissue Sleeve Assembly	2	—
	Lockout Tab	2	—

The Driver, Tissue Sleeve and Lockout Tab are included in the Damage Control Kit, 47-5300-010-00.

All content herein is protected by copyright, trademarks and other intellectual property rights, as applicable, owned by or licensed to Zimmer Biomet or its affiliates unless otherwise indicated, and must not be redistributed, duplicated or disclosed, in whole or in part, without the express written consent of Zimmer Biomet.

This material is intended for health care professionals. Distribution to any other recipient is prohibited.

Not for distribution in France.

Check for country product clearances and reference product specific instructions for use.

Zimmer Biomet does not practice medicine. This technique was developed in conjunction with a health care professional. This document is intended for surgeons and is not intended for laypersons. Each surgeon should exercise his or her own independent judgment in the diagnosis and treatment of an individual patient, and this information does not purport to replace the comprehensive training surgeons have received. As with all surgical procedures, the technique used in each case will depend on the surgeon's medical judgment as the best treatment for each patient. Results will vary based on health, weight, activity and other variables. Not all patients are candidates for this product and/or procedure. Caution: Federal (USA) law restricts this device to sale by or on the order of a surgeon. Rx only.

For complete product information, including indications, contraindications, warnings, precautions, potential adverse effects and patient counseling information, see the package insert and www.zimmerbiomet.com.

©2018 Zimmer Biomet



97-5300-002-00-REV1 09/18

 **Legal Manufacturer**
Zimmer, Inc.
1800 W. Center Street
Warsaw, Indiana 46580
USA

 Zimmer, U.K. Ltd.
9 Lancaster Place
Swindon, SN3 4FP, UK
www.zimmerbiomet.com

 0086

CE mark on a surgical technique is not valid unless there is a CE mark on the product label.