

# NCB<sup>®</sup> Periprosthetic Femur Plate System

Surgical Technique

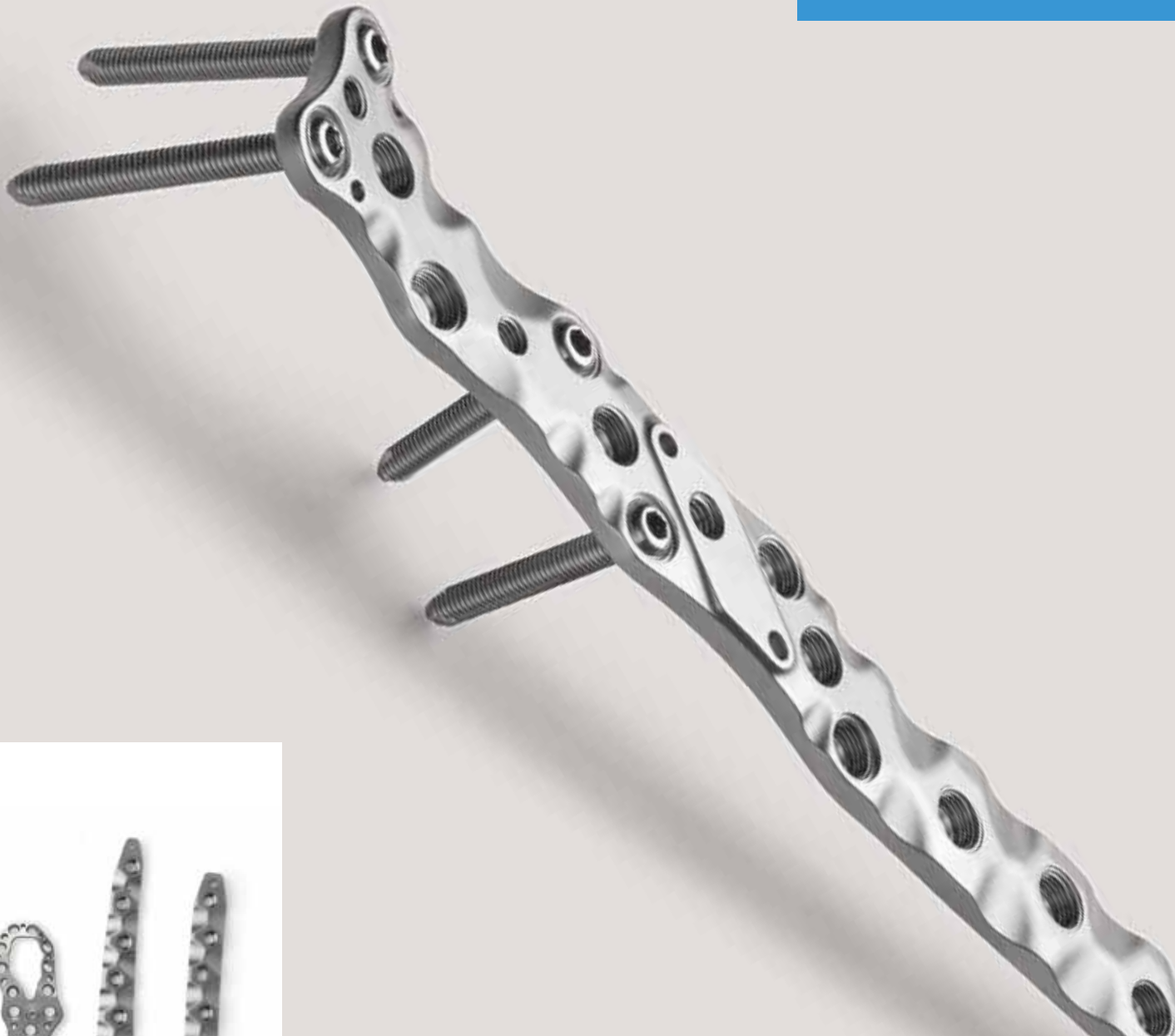



## Table of Contents

<b>Introduction</b>	<b>4</b>
<b>System Features and Benefits</b>	<b>9</b>
<b>Indications and Contraindications</b>	<b>13</b>
<b>Periprosthetic Femur Fracture Classification</b>	<b>14</b>
<b>NCB Periprosthetic Plate Positioning and Screw Fixation</b>	<b>16</b>
<b>NCB Screw Insertion</b>	<b>20</b>
<b>Screw Insertion for NCB Periprosthetic Trochanter Plate</b>	<b>22</b>
<b>NCB Periprosthetic Proximal Femur Plate – Surgical Technique</b>	<b>23</b>
<b>NCB Periprosthetic Distal Femur Plate – Surgical Technique</b>	<b>33</b>
<b>NCB Curved Femur Shaft Plate – Surgical Technique</b>	<b>39</b>
<b>NCB Bone Spacers (Optional)</b>	<b>44</b>
<b>NCB Blind Screw Inserts (Optional)</b>	<b>44</b>
<b>Tips and Tricks for the NCB Periprosthetic Femur System</b>	<b>45</b>
<b>Implant Removal</b>	<b>46</b>
<b>Product Information – Implants</b>	<b>47</b>
<b>Product Information – Instruments</b>	<b>51</b>
<b>Planning Aid</b>	<b>54</b>

## Introduction

The *NCB* (Non-Contact Bridging) Periprosthetic Femur System is a line of polyaxial locking plates designed for the treatment of femur fractures, particularly periprosthetic femur fractures. It consists primarily of a Proximal Femur Plate, a Distal Femur Plate, and a Curved Femur Shaft Plate.

In addition to that a Trochanter Plate is available to reattach the greater trochanter in combination with a Proximal Femur Plate.

The *NCB* Periprosthetic Proximal and Distal Femur Plates are wider in the area of the prosthesis and have offset holes that may allow bicortical screw placement in the area of the prosthesis.



*NCB* Periprosthetic Proximal Femur Plate



*NCB* Periprosthetic Trochanter Plate assembled with *NCB* Periprosthetic Proximal Femur Plate (short)



*NCB* Periprosthetic Distal Femur Plate



*NCB* Curved Femur Shaft Plate

The labeling of the *NCB* Periprosthetic Proximal and Distal Femur Plates corresponds with number of *NCB* Plate holes in a specific way.

Proximal Plates: the number of holes according label text = the number of all *NCB* screw holes distal to the MIS interface.

Distal Plates: the number of holes according label text = the number of all *NCB* screw holes proximal to the MIS interface.

**Example:** 12 hole plate  
= 2 x 3-hole pattern + 6.

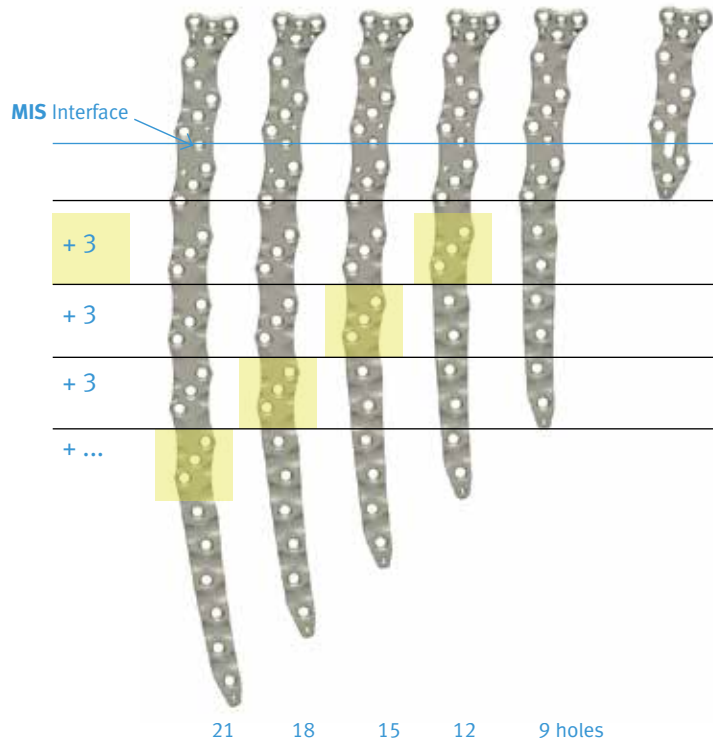

The *NCB* Periprosthetic Trochanter Plate is available in two different sizes (different width) whereas the height is the same. Due to the anatomical shape of the proximal femur a left and right version is offered.



The *NCB* System Technology allows for polyaxial screw placement (30° cone) with screw locking achieved through the use of locking caps that are threaded into the plate holes. The locking construct allows for improved stability especially in osteopenic bone. Before locking, the screws can act as lag screws and be used for fracture reduction; a benefit which is not offered with standard locking systems.



*NCB* 30° Cone Polyaxiality



Angular stability with the *NCB* Locking Caps

In the locked mode, the *NCB* Periprosthetic Plate acts as an internal fixator without contact between the plate and the bone surface, which may reduce the risk of periosteal blood supply impairment. This Non-Contact Bridging concept can also be controlled specifically through the use of 1, 2, or 3mm spacers, which are threaded into the plate holes prior to plate insertion.

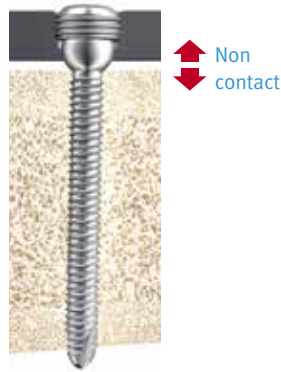

*NCB* Non-Contact Bridging



Locking cap  $\varnothing$  8mm



Blind screw insert



Spacer 1 to 3mm

The *NCB* Periprosthetic Trochanter Plate has a built in screw technology which gives surgeons the ability to create a fixed-angle construct while using familiar plating techniques. The locking screw heads contain male threads, while the holes in the plates contain female threads. This allows the screw head to be threaded into the plate hole, locking the screw into the plate. The heads are designed to create a nearly flush profile on the plate, which helps to decrease soft tissue irritation. The plate also allows anatomical reduction of the fracture fragments using standard cortical screws (non-locking).

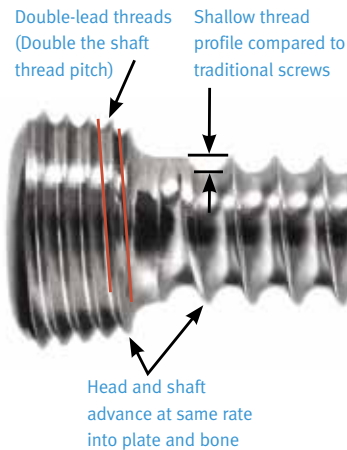

**NOTE: If lag screw fixation is necessary for any fragment, the lag screw must be inserted before inserting locking screws into that fragment.**

The *NCB* Periprosthetic Trochanter Plate contains different hole types.

**a) Hex Button holes:** used to place Hex Buttons in combination with cables around the plate and the femoral bone.

**b) Clearance holes for K-Wires:** used for preliminary fixation of the plates to the bone.

**c) Connection Screw holes:** used to assemble the *NCB* Periprosthetic Trochanter Plate to the *NCB* Periprosthetic Proximal Femur Plate. Screws must be tightened to 6Nm using the corresponding torque screwdriver (REF 02.00024.021).



**d) 3.5mm Screw holes:** used to place Zimmer® Universal Locking System (ULS) locking screws or cortical screws (non-locking).

**e) Clearance holes for NCB Screw holes:** used to place poly-axial locking screws (*NCB* Screws) or blue *NCB* Cable Buttons (REF 47-2232-060-01) in combination with cables around the plate and femoral bone.

**Note:** Do not use the gold *NCB* Locking Plate Cable Button (REF 47-2232-060-00) or Hex Button (REF 00-2232-002-35) in any clearance holes for *NCB* screw holes on the *NCB* Periprosthetic Trochanter Plate. If attaching cables, the blue *NCB* Cable Button (REF 47-2232-060-01) must be used in these holes when the Trochanter plate is attached. Using the wrong cable fixation option increases the likelihood of disengagement of the button which can lead to refracture or damage to the bone.

The surgical technique is based on well-known standard plate osteosynthesis techniques, which give the surgeon tactile feedback regarding bone quality during drilling and tightening of the screws. In addition, with the use of locking caps the screws can be locked and made angularly stable.

The *NCB* Periprosthetic Femur System allows for extensive flexibility in the treatment of periprosthetic fractures. The polyaxial *NCB* Plate technology, along with the offset plate holes, may allow for bicortical screw fixation around the stem of the implanted prosthesis. In this way, the surgeon can achieve better construct stability than with cables with less damage to the soft tissue. And because of the Non-Contact Bridging concept, the risk to the periosteal blood supply may be reduced.

Additionally, fixation using cables and cable buttons is possible for those cases where bicortical screw fixation cannot be achieved. Both techniques (locking screws and cables) may also be combined. Blunt tip unicortical *NCB* Screws are also available, creating a system which offers comprehensive solutions for these difficult fractures.



Bicortical screw anchorage around the stem with *NCB* Screws



Fixation using uni- and bicortical screws, as well as cables and cable buttons



## System Features and Benefits

### NCB Periprosthetic Proximal and Distal Femur Plates

#### Innovative Periprosthetic Plate Design

- Specific anatomical fit to the bone in left and right designs
- Wide plate design in the periprosthetic region to allow for bicortical screw fixation around the prosthesis, and narrow plate design on the rest of the plate to minimize soft tissue disruption.

#### MIS Interface

- MIS interface, consisting of three holes, allows for connection to the Targeting Device. See surgical technique REF 97-2370-010-00 for specific instructions.

#### Diagonal Three Hole Pattern

Diagonal three hole pattern allows for more screw options:

- Off-set holes allow for easier screw placement around the prosthesis and stable bicortical screw fixation. The holes accommodate 5.0mm *NCB* Screws, and two types of 4.0mm *NCB* Screws for use when there is minimal bone around the prosthesis.
- The central holes can accommodate threaded 5.0mm *NCB* Unicortical Screws, threaded Cable Buttons and Cables, when bicortical fixation cannot be achieved.

#### Differently Shaped Scallops

- Reduced and uniform plate stiffness.
- Better plate contouring across solid cross-sections, away from holes.

#### Divergent Screw Alignment

- Increased pull-out resistance.
- Reduced risk of fracture due to linear perforation of the bone.

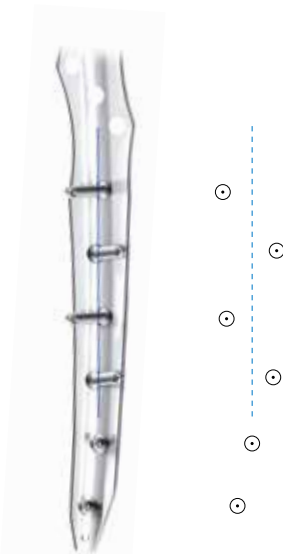
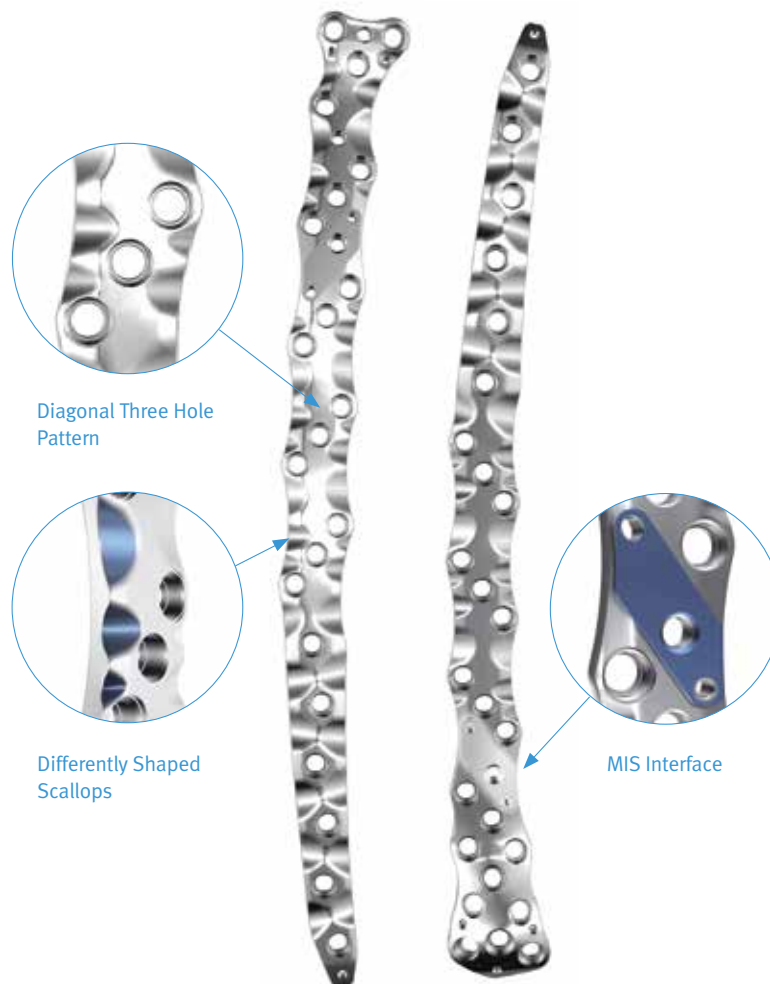

Divergent Screw Alignment (plate bottom side)

## NCB Periprosthetic Proximal Femur Plate

### Trochanter Plate Interface

Two threaded holes allow for connection with the *NCB* Periprosthetic Trochanter Plate to cover periprosthetic fractures in the trochanteric area.

### K-Wire Holes

Two proximal k-wire holes and one distal k-wire hole allow for easier preliminary fixation.

### Trochanter Plate

In combination with a Proximal Femur Plate the Trochanter Plate offers usage of ULS locking screws or cortical screws (non-locking) to re-attach the greater trochanter.

Additional holes allow for usage of HEX buttons to fix cables to the *NCB* Periprosthetic Trochanter Plate.

### Short Proximal Femur Plate

One adjustment slot is added to this specific plate which allows for preliminary fixation of the plate.

## NCB Periprosthetic Distal Femur Plate

### 95° Angled Distal Hole

The most distal central plate hole is angled at 95° to the plate shaft to allow screw insertion parallel to the joint. This can help reduce the fracture and may facilitate realignment of the anatomic axis of the femur.

### K-Wire Holes

- One proximal k-wire hole aids in preliminary plate fixation to bone.
- Three Distal k-wire holes are parallel to the most distal central plate hole to aid in femoral realignment.

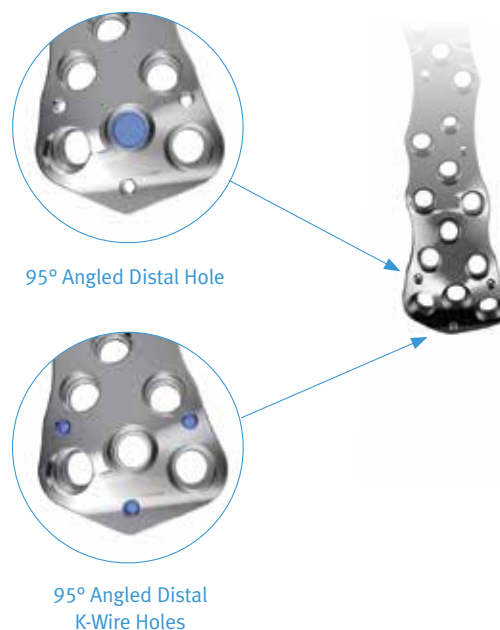
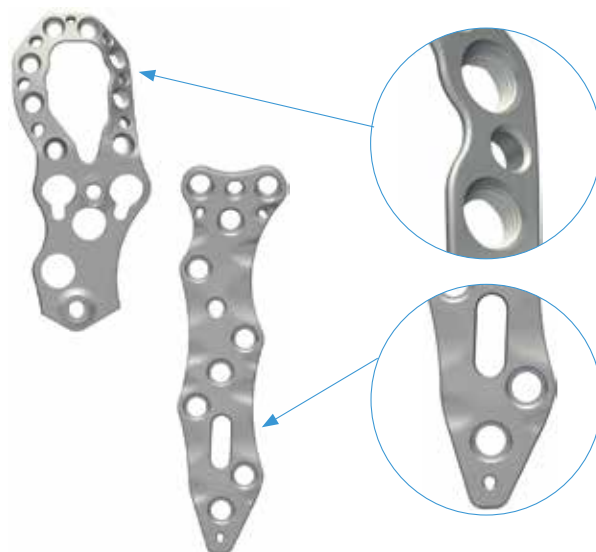

### NCB Curved Femur Shaft Plate

#### Symmetric Design

One plate for left and right femurs due to symmetric design.

#### Compression Slots

Two compression slots allow 1mm of compression each.

#### K-Wire Holes

Two k-wire holes at each end of the plate allow easier preliminary plate fixation.

#### Articulated Tension Device Holes



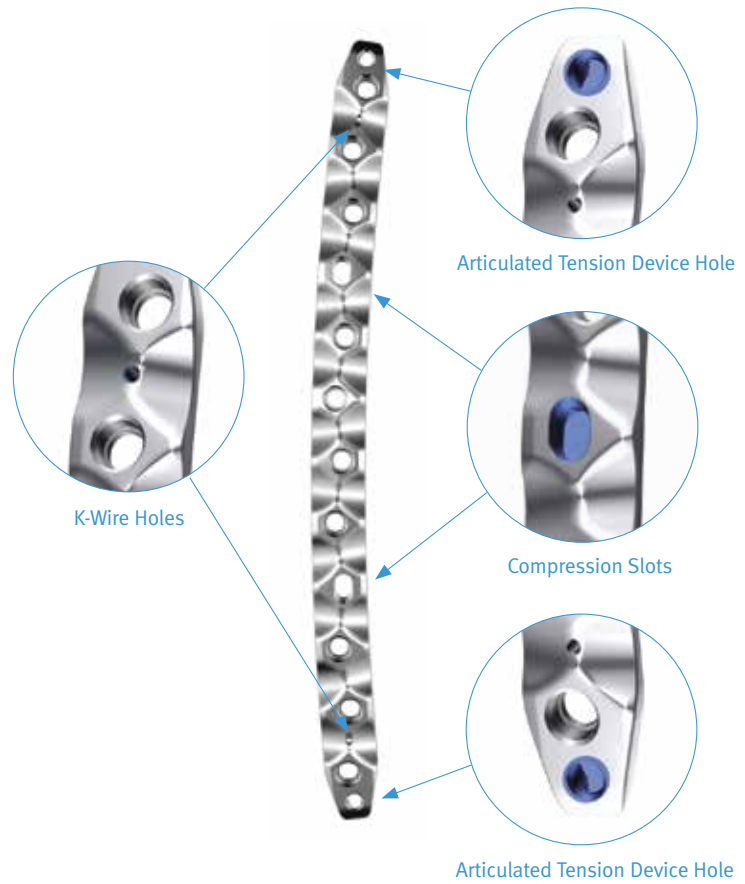





One hole at each end of the plate allows for connection of the Articulated Tension Device to achieve additional compression, if needed.



### NCB Periprosthetic Femur System

#### Broad Screw Options

Six different *NCB* Screw types and two different 3.5mm ULS locking screws and cortical screws (only for *NCB* Periprosthetic Trochanter Plate) are offered with the *NCB* Periprosthetic Femur System, to allow both bicortical and unicortical fixation.

Broad Screw Options	Ø mm	Description
	5	<i>NCB</i> Screws
	5	<i>NCB</i> Unicortical Screws
	5	<i>NCB</i> Cancellous Screws
	4	<i>NCB</i> Screws
	4	<i>NCB</i> Screws, Deep Thread
	3.5	ULS Locking Screw
	3.5	Cortical Screw
	5	<i>NCB</i> MotionLoc® Screws

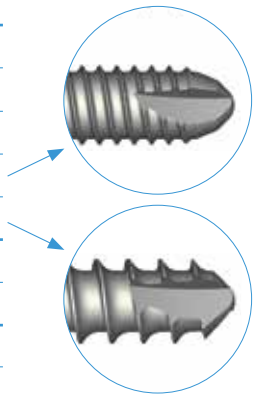

#### Specific Instruments for Periprosthetic Fractures

Slightly oversized drill bits and drill guides are offered with the *NCB* Periprosthetic Femur System, to reduce the risk of cracks in the cement mantle when placing screws around a cemented prosthesis.



*NCB* Instruments for overdrilling into cement

## Cable Fixation Options

The following products from the *Zimmer® Cable-Ready®* Cable Grip System are compatible with the *NCB* Periprosthetic Femur System: See data sheet REF 97-2232-015-00 for more specific instructions.



### NCB Locking Plate Cable Button, 2.5mm, Hex Drive

- Sterile
- Material: Ti6Al4V

REF 47-2232-060-00 Color: Gold\*  
REF 47-2232-060-01 Color: Blue

#### Application

This Cable Button is threaded directly into the *NCB* Plate hole to provide a positioning point for the Cable

#### Instructions

To insert, use the 2.5mm hex screwdriver to thread the cable button in to the plate hole. Do not fully tighten to allow the slots in the button to align with the cable.

To remove, use 2.5mm hex screwdriver to unthread the cable button from the plate hole.



### Hex Button, 3.5mm

- Sterile
- Material: C. P. Titanium

REF 00-2232-002-35

#### Application

This Hex Button fits into the standard hex in the screw head (3.5mm hex). Therefore, it can be inserted into the *NCB* Screw head, or into the *NCB* Locking Cap or directly into the specific holes of the *NCB* Periprosthetic Trochanter Plate.



### Cable Assembly Cerclage, 1.8mm

- Sterile
- Material: CoCr

REF 00-2232-002-28  
REF 00-2232-004-18

### Note

If adding cables to the *NCB* screw holes of the *NCB* Periprosthetic Trochanter plate, ensure that only the compatible blue *NCB* Cable Button (REF 47-2232-060-01) is used. See page 7 for details.



Cable Fixation Options



Cable Fixation Options  
(*NCB* Periprosthetic Trochanter Plate)



Cable Fixation with  
Cable Button



Cable Fixation with  
Hex Button

\* Not available in Europe, Middle East, and Africa

## Indications and Contraindications

### Indications

The *NCB* Periprosthetic Femur Polyaxial Locking Plate System is indicated for temporary internal fixation and stabilization of fractures and osteotomies of long bones, including:

- Periprosthetic fractures
- Comminuted fractures
- Supracondylar fractures
- Fractures in osteopenic bone
- Nonunions
- Malunions

The *NCB* Periprosthetic Trochanter Plate when used in combination with...

***NCB* Periprosthetic Proximal Femur Plate, short** (Length = 115mm) is indicated for temporary internal fixation and stabilization of fractures and osteotomies of the **greater trochanter**.

***NCB* Periprosthetic Trochanter Plate**

***NCB* Periprosthetic Proximal Femur Plates** (Length = 245mm, 285mm, 324mm, 363mm, 401mm) is indicated for temporary internal fixation and stabilization of fractures and osteotomies of the **proximal femur**.



In addition, both combinations are indicated for:

- Re-attachment of the greater trochanter following osteotomy in THA
- Re-attachment of the greater trochanter following fracture of greater trochanter
- Periprosthetic fractures
- Comminuted fractures
- Fractures in osteopenic bone
- Nonunions
- Malunions

### Contraindications

- All concomitant diseases that may impair the fixation of the implant and/or the success of the intervention
- Lack of bone substance or poor bone quality which makes stable seating of the implant impossible
- Acute or chronic, local or systemic infections
- Allergy to the implanted materials
- Severe muscular, neural or vascular diseases that endanger the extremities involved
- Loose prosthesis, which requires immediate revision
- If the *NCB* Periprosthetic Trochanter Plate is used in combination with the *NCB* Periprosthetic Proximal Femur Plate short (Length=115mm), Femoral Neck Fracture is a contraindication as well

## Periprosthetic Femur Fracture Classification

Comprehensive classification systems for periprosthetic femur fractures are the Vancouver classification for fractures following Total Hip Arthroplasty (THA), and the Lewis and Rorabeck Classification for fractures following a Total Knee Arthroplasty (TKA).

### Fractures around Hip Implants

According to the Vancouver classifications, Type B1 (fracture located around the tip of the hip prosthesis) and Type C periprosthetic fractures (fracture located well below the tip of the hip prosthesis), both with a stable implant, may be treated with ORIF (Open Reduction Internal Fixation). For such fractures, either the *NCB* Periprosthetic Proximal Femur Plate or the *NCB* Curved Femur Shaft Plate may be used.

### Vancouver Classification

**Type A Fracture:** occurs at the proximal part of the femur with displacement of the greater trochanter or lesser trochanter

**Type B1 Fracture:** occurs around or just distal to a well-fixed femoral stem

**Type B2 Fracture:** occurs around or just distal to a loose femoral stem with adequate proximal bone

**Type B3 Fracture:** occurs around or just distal to a loose femoral stem with poor proximal bone stock

**Type C Fracture:** occurs well distal to the stem tip

### Vancouver Classification



Type A



Type B1



Type B2



Type B3



Type C

### Fractures around Knee Implants

Periprosthetic femoral fractures following a TKA which are usually treated with ORIF are Type II fractures of the Lewis and Rorabeck Classification (displaced fractures where the knee prosthesis is intact). For such fractures the *NCB* Periprosthetic Distal Femur Plate may be used.

#### Lewis and Rorabeck Classification

**Type I Fracture:** Non-displaced fracture. Prosthesis intact

**Type II Fracture:** Displaced fracture. Prosthesis intact

**Type III Fracture:** Non-displaced or displaced fracture. Prosthesis loose or failing

#### Lewis and Rorabeck Classification



Type I



Type II

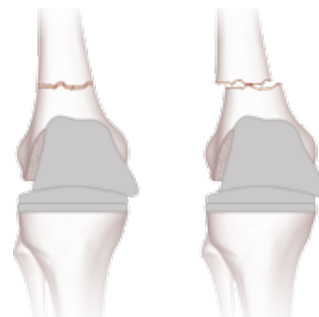

Type III

## NCB Periprosthetic Plate Positioning and Screw Fixation

### Recommended NCB Periprosthetic Plate Positioning

- Ensure that the length of the *NCB* Periprosthetic Proximal Femur or Distal Femur Plate allows for screw placement around the existing prosthesis along the diagonal three hole pattern in the widest area of the plate.
- The widest part of the plate should be placed on the fracture site. Do not place the narrow part of the plate over the fracture site.

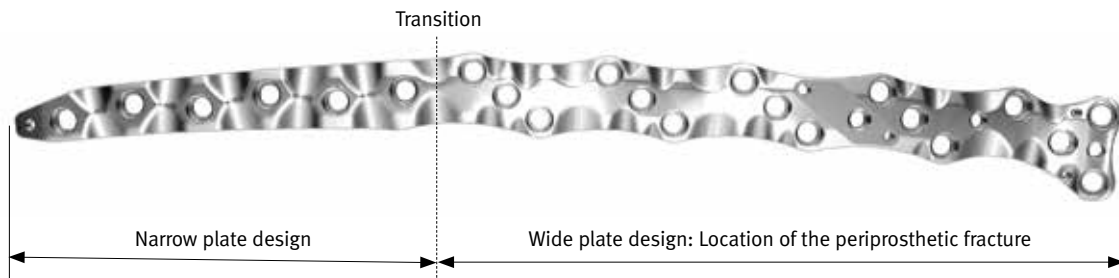

*NCB* Periprosthetic Proximal Femur Plate and fracture location

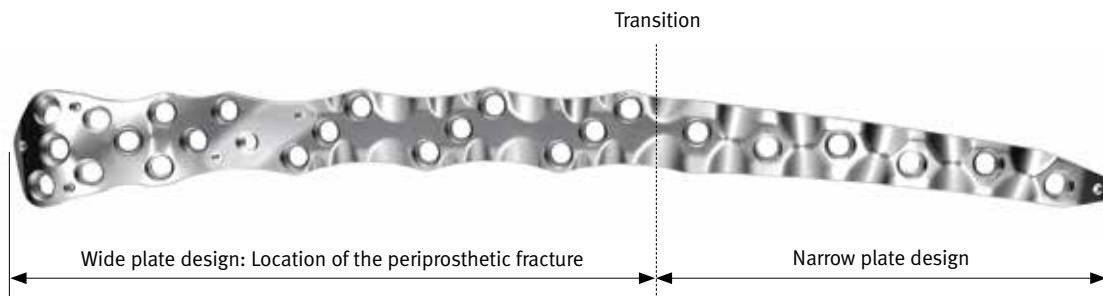

*NCB* Periprosthetic Distal Femur Plate and fracture location



### Recommended NCB Screw Fixation

The NCB Periprosthetic Femur System offers five different types of polyaxial locking screws, four of them are designed for bicortical purchase, and one of them is designed for unicortical purchase.





In addition, Ø5.0mm Zimmer MotionLoc Screws are also compatible with the NCB Periprosthetic Femur System and have a more specific instruction in the Surgical Technique (REF: 97-3161-004-00).

Recommended NCB Screw usage for NCB Periprosthetic Proximal Femur and Distal Femur Plates:

- Use two bicortical 5.0mm NCB Screws close to the fracture on each side of the fracture.
- Wherever possible, use 5.0mm bicortical NCB Screws. For thin cortical bone near the prosthesis, the 4.0mm NCB Screws may be used.

**Note:** the 4.0mm NCB Screws, deep thread are only recommended for use around the implanted prosthesis when the cortical wall is too thin to use even with the 4.0mm NCB Screws. They are not recommended for use near the fracture site.

The **4.0mm NCB Screws, Deep Thread** have a smaller core diameter than the 4.0mm NCB Screws (2.9mm versus 3.4mm), which allows for a more aggressive thread design for improved anchorage in thin bone. Furthermore, as the core diameter is smaller, less bone is removed during drilling and screw insertion.

	NCB Screws – Bicortical				Unicortical
Screw Type	Cortical 5mm	Cortical 4mm	Cortical 4mm Deep Thread	Cancellous Partially threaded	Cortical Blunt Tip
					
Outer Ø	5mm	4mm	4mm	5mm	5mm
Core Ø	4.4mm	3.4mm	2.9mm	2.9mm	4.4mm
Length	22–100mm	20–65mm	20–65mm	50–100mm	10–20mm
REF	02.03150.xxx	02.03155.xxx	02.03154.xxx	02.03152.xxx	02.03151.xxx
REF Sterile	02.02150.xxx	02.02155.xxx	02.02154.xxx	02.02152.xxx	02.02151.xxx
Application	Close to the fracture area, in the shaft area, or where there is no risk of hitting the prosthesis	Away from the fracture area to achieve bicortical fixation around the prosthesis	Away from the fracture area to achieve bicortical fixation around the prosthesis when fixation even with the 4.0mm cortical standard screws is impossible	Metaphyseal area of the Distal Femur	For use when bicortical fixation cannot be achieved  <b>Warning</b> If only unicortical screws are used, the use of cables is required
Drill Bit Ø	4.3 / 4.5mm	3.3 / 3.5mm	3.0mm	2.5mm	4.3 / 4.5mm
Drill Bit REF	02.00024.002 02.00024.330*	02.00024.118 02.00024.325*	02.00024.301 –	103.25.180 –	02.00024.002 02.00024.330*
Tap REF	02.00024.341	02.00024.340	02.00024.305	–	02.00024.341
Drill Guide REF	02.00024.011 02.00024.331	02.00024.111 02.00024.326	02.00024.310 –	02.00024.010 –	02.00024.011 02.00024.331

NCB Screw portfolio for the NCB Periprosthetic Femur System

\* Titanium nitride coated drill bits for drilling into the cement mantle



## Recommended Screw Fixation for NCB Periprosthetic Trochanter Plate

The *NCB* Periprosthetic Femur System offers two additional types of screws to be used with the *NCB* Periprosthetic Trochanter Plate, ULS locking screw and cortical screw (non-locking).

Recommended Screw usage for *NCB* Periprosthetic **Trochanter Plates**:

- Use at least three 3.5mm screws placing them both anterior and posterior to the prosthesis.
- If using two 3.5mm screws in the most proximal holes to secure the trochanteric fragment, add two additional screws distally.
- Screws should be placed through fracture zone, or osteotomy gap.

**FOR EMEA (Europe, Middle East, and Africa) ONLY:**  
Instead of using the 3.5mm cortical screws from the ULS system (00-4935-xxx-35) standard 3.5mm cortical screws (02.03131.xxx) can be implanted as well.

Screw Type	ULS Screws		Cortical Screws (FOR EMEA ONLY)
	Locking 3.5mm	Cortical 3.5mm	Cortical 3.5mm
Outer ∅	 3.5mm	 3.5mm	 3.5mm
Core ∅	2.7mm	2.4mm	2.4mm
Length	12–60mm*	12–60mm**	12–60mm
REF	00-2369-xxx-35	00-4935-xxx-01	02.03131.xxx
REF Sterile	47-2369-xxx-35	47-4935-xxx-01	—
Application	Trochanteric area in locked mode	Trochanteric area in non-locked mode	Trochanteric area in non-locked mode
Drill Bit ∅	2.7mm	2.5mm	2.5mm
Drill Bit REF	00-2360-205-27	00-4807-180-25	00-4807-180-25
Tap REF	00-2360-153-35	00-4811-110-35	00-4811-110-35
Drill Guide REF	00-2360-020-27	00-4808-035-01	00-4808-035-01

Screw portfolio for the *NCB* Periprosthetic Femur System  
(Trochanter Plate)

\* Longer sizes (60mm – 90mm, 5mm steps) are available upon request sterile packed

\*\* Longer sizes (60mm – 95mm, 5mm steps) are available upon request sterile packed

1. Standard NCB Screw Fixation Standard NCB Screw Fixation



Shows a standard NCB Plate used in a non periprosthetic fracture.

2. Standard NCB Screw Fixation Recommended NCB Periprosthetic Screw Fixation



Indicates recommended NCB Screw fixation for the NCB Periprosthetic Plate in periprosthetic fractures. Bicortical screw fixation with at least four NCB Screws is recommended along the diagonal three hole pattern in the widest section of the plate. Place screws both anterior and posterior to the prosthesis.

**Warning:** Do not insert three screws in one diagonal three hole pattern, because it creates a stress riser in the bone.

When no prosthesis is present beneath the plate standard NCB Screw fixation can be applied.

**Note:** To prevent thread stripping and allow for adequate bone purchase, pass screws as centrally through the bone as possible. In addition, irrigation may be used during drilling to help prevent thermal necrosis.

3. Standard NCB Screw Fixation Alternative NCB Periprosthetic Screw Fixation



Demonstrates a situation where four bicortical NCB Screws cannot be placed along the diagonal three hole pattern in the wide part of the plate. To ensure stable fracture fixation, the use of one or two divergent 5.0mm NCB Unicortical Screws is recommended. If only one bicortical screw can be placed in the offset holes of a given diagonal three hole pattern, place one 5.0mm NCB Unicortical Screw in the central hole of that three-hole pattern.

4. Standard NCB Screw Fixation Alternative NCB Periprosthetic Screw Fixation with Cable



Demonstrates a situation where a threaded cable button and cable are used as an optional fixation method, when additional fixation is required.

- NCB Screw Ø 5mm
- NCB Screw Ø 5 or 4mm, or  
NCB Screw Ø 4mm, Deep Thread
- NCB Unicortical Screw Ø 5mm
- Cable Ready Cable-Button and Cable

Recommended NCB Screw fixation for the NCB Periprosthetic Proximal Femur and Distal Femur Plates



**Warning:** Do not insert three screws in one diagonal three hole pattern, because it creates a stress riser in the bone.

## NCB Screw Insertion

### For All Types of NCB Screws and NCB Locking Caps

- Do not hit the prosthesis with the tip of the drill, tap or screw.
- Take care to avoid collision of the screws by choosing the appropriate plate holes and screw lengths.
- Press the *NCB Drill Guide* into the plate hole perpendicular to the plate and then tilt it in the preferred direction. The drill guide needs to be in constant contact with the bottom ring of the hole. The guide limits the angulation to 15° from the perpendicular axis of the plate or a cone of 30° for placing a locked *NCB Screw*. Always use the drill guide since it prevents selection of an excessive screw angle and failure of subsequent locking.
- Screws may be inserted under power but should be final tightened by hand only.
- Lock the construct, insert and tighten the *NCB Locking Caps* (REF 02.03150.300) by using the *NCB Torque Limiting Screwdriver*, 6Nm (REF 02.00024.021) until a click sound is heard. Make sure the screwdriver is not tilted during its usage. If the driver is tilted, it could damage the hex drive and might complicate the extraction of the implants.

### For Zimmer MotionLoc Screws

See surgical technique REF 97-3161-004-00 for more specific instructions.

### NCB Screw Ø 5.0mm



1. To insert a 5.0mm *NCB Screw* (REF 02.03150.xxx) use the 4.3mm *NCB Drill Guide* (REF 02.00024.011) and drill with the 4.3mm drill bit (REF 02.00024.002).

In case of hard cortical bone or the presence of a cement mantle, tap the cortex with the 5.0mm *NCB Tap* (REF 02.00024.341). Remove the 4.3mm *NCB Drill Guide* before using the *NCB Tap*.

**Note:** The 4.3mm drill bit can drill a maximum of 105mm deep when used with the drill guide. If a longer screw is needed, remove the drill guide and drill the additional depth free hand.

**Note:** Inserting screws in the presence of a cement mantle can cause cracks, which may cause loosening of the prosthesis. Overdrilling by using a drill bit of a slightly larger diameter (0.2mm) may reduce cracking in the cement mantle during screw insertion. Instead of the 4.3mm drill bit, use the 4.5mm drill bit (REF 02.00024.330) and its corresponding drill guide (REF 02.00024.331).<sup>1</sup>

2. Use the *NCB Measuring Device* (REF 02.00024.005) to determine the appropriate screw length and insert the *NCB Screw* using the *NCB Hexagonal Screwdriver* (REF 02.00024.023) or screwdriver shaft (REF 02.00024.024).
3. To lock the construct, insert the *NCB Locking Caps* (REF 02.03150.300) as described at the beginning of this section.

### NCB Unicortical Screw Ø 5.0mm



**Warning:** If only unicortical screws are used, the use of cables is required.

1. To insert a 5.0mm *NCB Unicortical Screw* (REF 02.03151.0xx) use the 4.3mm *NCB Drill Guide* (REF 02.00024.011) and drill with the 4.3mm drill bit (REF 02.00024.002).

In case of hard cortical bone or the presence of cement mantle, tap the cortex with the 5.0mm *NCB Tap* (REF 02.00024.341). Remove the 4.3mm *NCB Drill Guide* before using the *NCB Tap*.

**Note:** Inserting screws in the presence of a cement mantle can cause cracks, which may cause loosening of the prosthesis. Overdrilling by using a drill bit of a slightly larger diameter (0.2mm) may reduce cracking in the cement mantle during screw insertion. Instead of the 4.3mm drill bit, use the 4.5mm drill bit (REF 02.00024.330) and its corresponding drill guide (REF 02.00024.331).<sup>2</sup>

2. Use the *NCB Measuring Device* (REF 02.00024.005) to determine the appropriate screw length and insert the *NCB Unicortical Screw* using the *NCB Hexagonal Screwdriver* (REF 02.00024.023).

**Note:** When using the *NCB Measuring Device* to measure the length of the *NCB Unicortical Screw* needed, the device will not hook the far cortex of the bone. Use the screw length measured. Do not use a longer screw.

3. To lock the construct, insert the *NCB Locking Caps* (REF 02.03150.300) as described at the beginning of this section.

1, 2 J. Kampshoff et al.: The treatment of periprosthetic fractures with locking plates: effect of drill and screw type on cement mantles: a biomechanical analysis, Archives of Orthopedic and Trauma Surgery, Springer, March 2009.

**NCB Cancellous Screw ∅ 5.0mm**

1. To insert a 5.0mm *NCB* Cancellous Screw (REF 02.03152.xxx) use the *NCB* 2.5mm Drill Guide (REF 02.00024.010) and use the 2.5mm drill bit (REF 103.25.180).

In case of hard cortical bone drill the cortex with a 4.3mm drill bit (REF 02.00024.002) by using the 4.3mm *NCB* Drill Guide (REF 02.00024.011).

**Note:** Use the 5.0mm *NCB* Cancellous Screws only in cancellous bone.

**Note:** The 2.5mm drill bit can drill a maximum of 90mm deep when used with the drill guide. If a longer screw is needed, remove the drill guide and drill the additional depth free hand.

2. Use the *NCB* Measuring Device (REF 02.00024.005) to determine the appropriate screw length and insert the *NCB* Cancellous Screw using the *NCB* Hexagonal Screwdriver (REF 02.00024.023) or screwdriver shaft (REF 02.00024.024). Cancellous screws are partially threaded and can be used as lag screws to reduce the fracture and obtain close contact between the plate and the bone.

3. To lock the construct, insert the *NCB* Locking Caps (REF 02.03150.300) as described at the beginning of this section.

**NCB Screw ∅ 4.0mm**

1. To insert a 4.0mm *NCB* Screw (REF 02.03155.0xx) use the 3.3mm *NCB* Drill Guide (REF 02.00024.111) and drill with the 3.3mm drill bit (REF 02.00024.118).

In case of hard cortical bone or the presence of the cement mantle, tap the cortex with the 4.0mm *NCB* Tap (REF 02.00024.340). Remove the 3.3mm *NCB* Drill Guide before using the *NCB* Tap.

**Note:** Inserting screws in the presence of a cement mantle can cause cracks, which may cause loosening of the prosthesis. Overdrilling by using a drill bit of a slightly larger diameter (0.2mm) may reduce cracking in the cement mantle during screw insertion. Instead of the 3.3mm drill bit, use the 3.5mm drill bit (REF 02.00024.325) and its corresponding drill guide (REF 02.00024.326).<sup>1</sup>

2. Use the *NCB* Measuring Device (REF 02.00024.005) to determine the appropriate screw length and insert the *NCB* Screw using the *NCB* Hexagonal Screwdriver (REF 02.00024.023) or screwdriver shaft (REF 02.00024.024).

3. To lock the construct, insert the *NCB* Locking Caps (REF 02.03150.300) as described at the beginning of this section.

**NCB Screw ∅ 4.0mm, Deep Thread**

1. To insert a 4.0mm *NCB* Screw, Deep Thread (REF 02.03154.0xx) use the 3.0mm *NCB* Drill Guide (REF 02.00024.310) and drill with the 3.0mm drill bit (REF 02.00024.301).

In case of hard cortical bone or the presence of the cement mantle, tap the cortex with the 4.0mm *NCB* Tap, Deep Thread (REF 02.00024.305). Remove the 3.0mm *NCB* Drill Guide before using the *NCB* Tap.

2. Use the *NCB* Measuring Device (REF 02.00024.005) to determine the appropriate screw length and insert the *NCB* Screw, Deep Thread using the *NCB* Hexagonal Screwdriver (REF 02.00024.023) or screwdriver shaft (REF 02.00024.024).

3. To lock the construct, insert the *NCB* Locking Caps (REF 02.03150.300) as described at the beginning of this section.

<sup>1</sup> J. Kampshoff et al.: The treatment of periprosthetic fractures with locking plates: effect of drill and screw type on cement mantles: a biomechanical analysis, Archives of Orthopedic and Trauma Surgery, Springer, March 2009.

## Screw Insertion for NCB Periprosthetic Trochanter Plate

### For All Types of 3.5mm Screws

- Do not hit the prosthesis with the tip of the drill, tap or screw.
- Take care to avoid collision of the screws by choosing the appropriate plate holes and screw lengths.
- Screws may be inserted under power but should be final tightened by hand only to avoid crossthreading of the screw in the plate hole or breakage of the screw or driver.

### ULS Locking Screw $\varnothing$ 3.5mm

1. To insert a 3.5mm ULS locking screw (REF 00-2369-xxx-35 / 47-2369-xxx-35) thread a Standard Drill Cannula 2.7mm (REF 00-2360-020-27) into the plate hole where you plan to place the first locking screw.
2. Insert the 2.7mm Drill Bit (REF 00-2360-205-27) through the cannula and drill to the appropriate depth. In case of hard cortical bone or the presence of a cement mantle, tap the cortex with the 3.5mm Tap (REF 00-2360-153-35). Remove the cannula and the drill bit before using the Tap.
3. Use the Depth Gauge (REF 00-2360-040-35 for screws up to 60mm to determine the appropriate screw length and insert the ULS screws using the Small Hex Screwdriver (REF 00-4812-035-00) or HEX Screwdriver Shaft (REF 00-2360-165-25).
4. Make sure that all locking screws are securely tightened before closing.

### Cortical Screw $\varnothing$ 3.5mm

1. To insert a 3.5mm cortical screw (REF 00-4935-xxx-01 / 47-4935-xxx-01 or 02.03131.0xx) use the Double Drill Sleeve (REF 00-4808-035-01) and the 2.5mm Drill Bit (REF 00-4807-180-25). In case of hard cortical bone or the presence of a cement mantle, tap the cortex with the 3.5mm Tap (REF 00-4811-110-35). Remove the Double Drill Sleeve before using the Tap.
  2. Use the Depth Gauge (REF 00-4810-002-01) for screws up to 60mm to determine the appropriate screw length and insert the cortical screws using the Small Hex Screwdriver (REF 00-4812-035-00) or HEX Screwdriver Shaft (REF 00-2360-165-25).
- While inserting the first cortical screw be careful not to tilt the plate.

## NCB Periprosthetic Proximal Femur Plate – Surgical Technique

### Preoperative Planning and Patient Positioning

#### Preoperative Planning

Preoperative planning with adequate x-rays and x-ray templates for the *NCB Periprosthetic Proximal Femur Plate* (Lit 06.02024.000) and the *NCB Periprosthetic Trochanter Plate* (Lit 06.02262.000) is strongly recommended. If necessary, use CT scans if osteolysis is present.

This allows determination of the proper plate length, and the appropriate type and position of screws, particularly in the presence of a hip prosthesis to prevent any interference with the hip stem.

Determine which prosthesis has been implanted by studying the x-rays, or using the previous surgeon's operative notes to be prepared in case of revision, and assess the stability of the prosthesis. If the prosthesis is loose, the surgical plan may change to include revision.

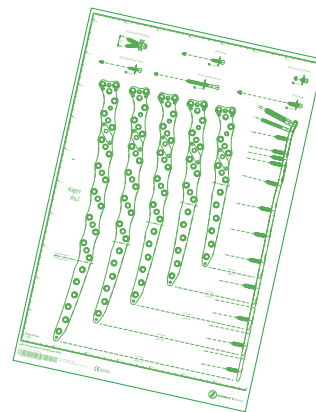

#### Patient Positioning

Lay the patient in the lateral position or the supine position on a radiolucent table. Support the knee, but allow the leg to move freely.

If intra-op fluoro is to be used, ensure the fluoro machine is not blocked by radiopaque bars of the operating table.

Patient in the lateral position

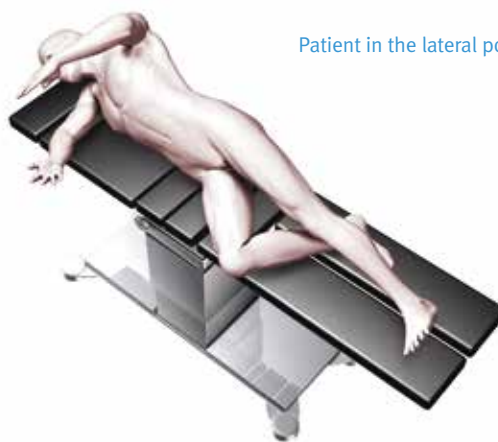

Patient in the supine position

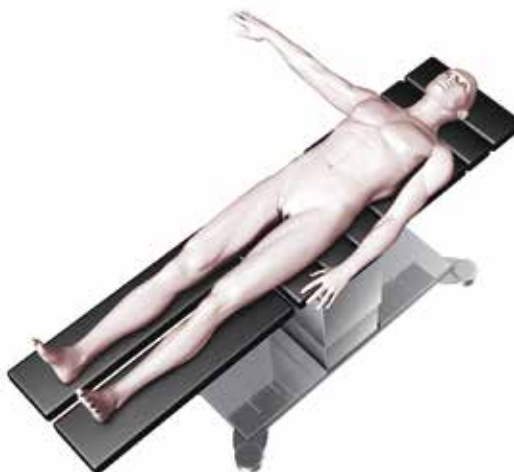

## Incision and Intra-operative Planning

**Note:** Check to see if the prosthesis is loose before reduction. If the prosthesis is loose, revision may be indicated.

### Incision

Make the incision using the lateral subvastus approach or incorporate the existing incision, if applicable. Avoid excessive stripping of the soft tissue and keep the periosteum intact.

### Intra-operative Planning

Take complete x-rays of the femur in the A/P and lateral views, occasional if necessary in the contra-lateral view to determine the length of the prosthesis, as well as the correct plate length to be implanted. Please refer to pages 14–16.

**Note:** The prosthesis length as well as the fracture location determines the plate length selected, with the length of the patient's bone as a secondary guide.

If the length of the prosthesis is between two plate sizes, choose the longer one.

If desired, the *NCB Periprosthetic Proximal Femur Plate Provisionals* (REF 02.00024.35x) can be used to determine the suitable implant length. Provisionals are semi radiolucent and intended to be used in the open technique.

Each provisional represents the implant sizes it is labeled for e.g. 12 holes. To use the provisional for the next shorter implant size (e.g. 9 hole plate), two square holes are included:

- the proximal square hole indicates the end of the periprosthetic zone
- the distal square hole indicates the most distal *NCB Plate* hole of the next shorter implant size.

For every size of the *NCB Periprosthetic Trochanter* plate a specific provisional is provided.

**Warning:** Do not implant or bend the provisional.



Incision



Excessive stripping of the soft tissue avoided and periosteum kept intact

*NCB Periprosthetic Proximal Femur Plate Provisional* used for intra-operative planning (optional)

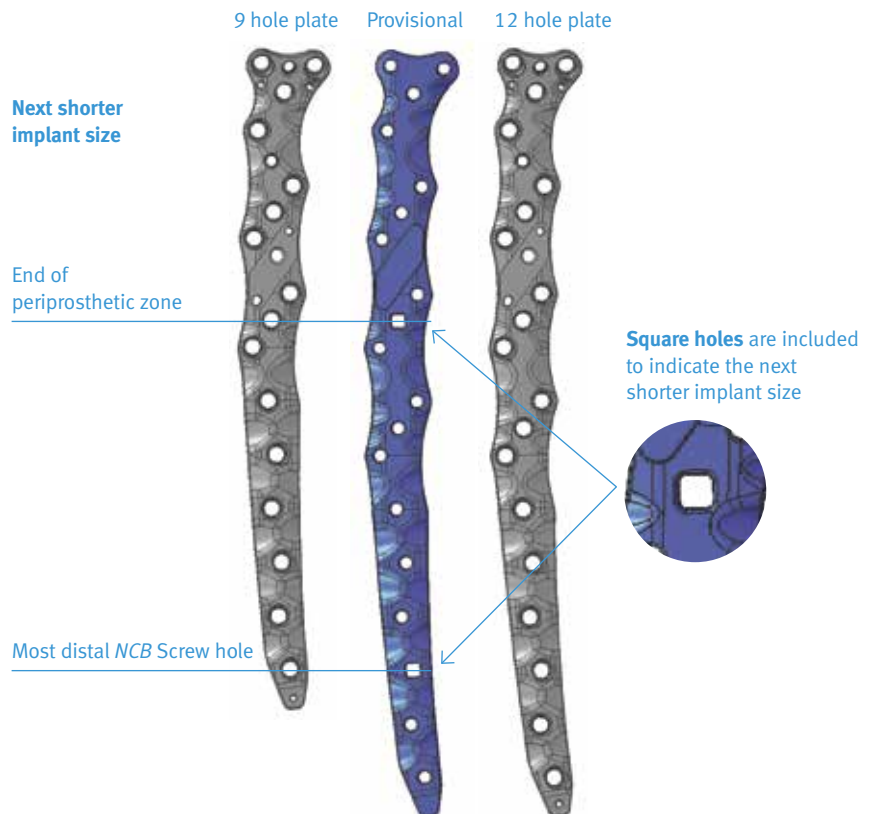



## Reduction and Preliminary Fixation

Reduce the fracture prior to inserting the plate. Bone fragments can be secured with 2.0mm k-wires (REF 290.20.280) or clamps such as pointed reduction forceps. Ensure that preliminary fixation devices do not interfere with the future location of the plate and screws, or with the prosthesis.



Assembling the *NCB Periprosthetic Trochanter Plate* with the *NCB Periprosthetic Proximal Femur Plate* using the *NCB DF Torque Screwdriver 6Nm*.

## Insertion of the *NCB Periprosthetic Proximal Femur Plate*

Lift the vastus lateralis' origin with an "L" shaped incision and insert the appropriate left or right *NCB Periprosthetic Proximal Femur* plate just below the vastus tubercle until you achieve good contact with the bone. Make sure that the plate is on bone distally as well.

If using the *NCB Periprosthetic Trochanter Plate* in combination with the *NCB Periprosthetic Proximal Femur Plate* make sure that the two plates are assembled prior to insertion. Use the *NCB DF Torque Screwdriver 6Nm* (REF 02.00024.021) to screw in the two Connection Screws which come pre-assembled with the *NCB Periprosthetic Trochanter Plate*.

**Note:** Do not use the *NCB Periprosthetic Proximal Femur Plate* short or the *NCB Periprosthetic Trochanter Plate* as stand-alone implants! The *NCB Periprosthetic Trochanter* always needs to be assembled with a *NCB Periprosthetic Proximal Femur Plate*.

If small bone fragments are present in the trochanteric region the use of additional cable osteosynthesis is recommended. A HEX button can be used in the non-threaded holes of the *NCB Periprosthetic Trochanter Plate* to guide the cable over the plate.

**Surgical Technique Tip:** For additional stability a cable can be used through the two most proximal holes (foreseen for HEX buttons) in the *NCB Periprosthetic Trochanter Plate*. Leave the cable loose on the proximal side to have space for the two proximal 3.5mm screws. After inserting the screws the cable can be placed around the femoral neck / shaft and tightened.



*NCB Periprosthetic Proximal Femur Plate* positioned and temporarily fixed proximally and distally with 2.0mm k-wires

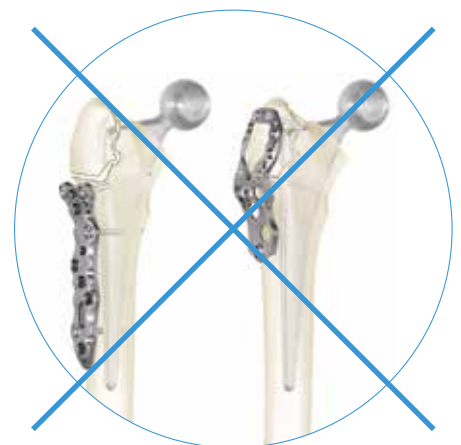

Center the plate on the bone shaft in the lateral view. Ensure the distal end of the plate does not lift off the bone anteriorly or posteriorly which can cause post-op pain.

Temporarily fix the plate with 2.0mm k-wires (REF 290.20.280) proximally and distally.

**Note:** The *NCB* Periprosthetic Proximal Femur Plate is anatomically shaped. If additional contouring is required, use the Bending Press Inserts (REF 02.00024.315/6) and the corresponding Bending Press (REF 100.06.010).

Be aware that bending the plate may decrease its fatigue strength. Furthermore, the locking mechanism of the *NCB* hole may be damaged and, therefore, may no longer function. Do not use a hole that has been altered by contouring for locking. If the plate is bent, the MIS guide cannot be used.

**Note:** Do not bend the *NCB* Periprosthetic Femur Plate proximal to the MIS interface or the adjustment slot (short *NCB* Periprosthetic Proximal Femur Plate) when used in combination with the *NCB* Periprosthetic Trochanter Plate, because it will compromise the attachment between the two plates.

**Note:** Do not bend the *NCB* Periprosthetic Trochanter Plate.

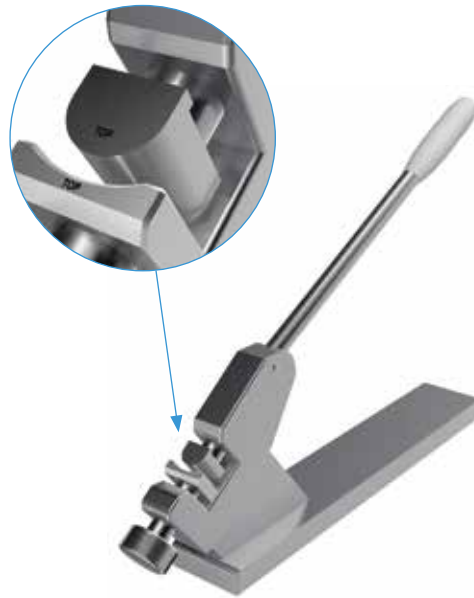

Correct orientation of the concave Bending Press insert: with the word "TOP" etched on the top of the insert

### Insertion of the NCB Screws (without NCB Periprosthetic Trochanter Plate)

The actual configuration should always be determined based on the fracture type and bone quality. For screw selection and the surgical procedure on how to insert a *NCB* Screw, please refer to pages 17–21.

**Note:** Ensure that existing other medical devices and their fixation and/or anchorage elements are not affected or damaged by drill bits, taps, or screws.

#### Insertion of the NCB Screws Proximally

**1.** Insert a *NCB* Screw into one of the two most proximal plate holes.

**Note:** The screw selection should be considered with respect to the thickness of the cortex. For thin cortex, start by drilling a pilot hole for a 4.0mm *NCB* Screw, and subsequently enlarge it for a 5.0mm *NCB* Screw, if space permits.

**Note:** Do not fully tighten the first screw as it may tilt the plate.

**2.** Insert the second *NCB* Screw in the next proximal screw hole of the plate. After the second screw is inserted in the proximal screw hole, then both screws can be tightened.

**Note:** Screws should not be locked until the distal fragment has been fixed.



First *NCB* Screw inserted in one of the two most proximal plate holes

Second *NCB* Screw inserted in the opposite most proximal screw hole of the plate

### Insertion of the NCB Screws along the Shaft

**3.** Insert the third *NCB* Screw anterior or posterior to the prosthesis in a diagonal three hole pattern along the femur shaft and proximal to the fracture.

**4.** Insert the fourth *NCB* Screw in the opposite hole of the same diagonal three hole pattern, creating a grip around the prosthesis.

**Note:** Bicortical screw fixation of at least four screws alternating anterior and posterior to the prosthesis is recommended.

If there is not enough cortex for two bicortical screws around the prosthesis in the same diagonal three hole pattern, insert one screw bicortically and one 5.0mm *NCB* Unicortical Screw in the central hole, to provide stability.

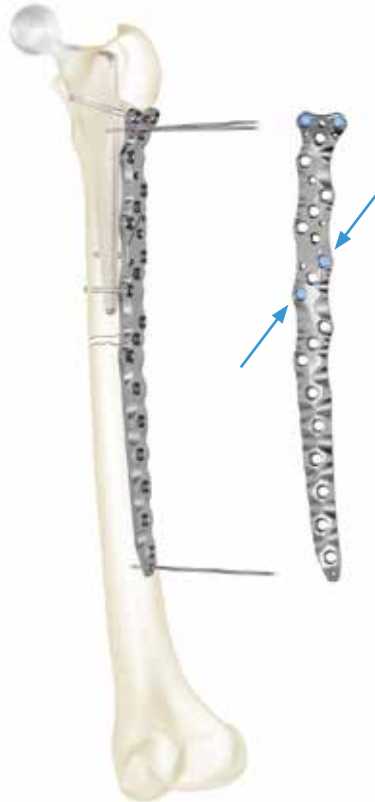

Third *NCB* Screw inserted anterior or posterior to the prosthesis in a diagonal three hole pattern along the femur shaft and proximal to the fracture

Fourth *NCB* Screw inserted in the opposite hole of the same diagonal three hole pattern, creating a grip around the prosthesis

**Insertion of the NCB Screws Distally**

Insert at least three bicortical *NCB* Screws distal to the fracture area and to the prosthesis.

**Insertion of additional *NCB* Screws**

Insert additional *NCB* Screws as necessary to provide optimal fixation and remove the k-wires. If screws are not enough, cables can be added.

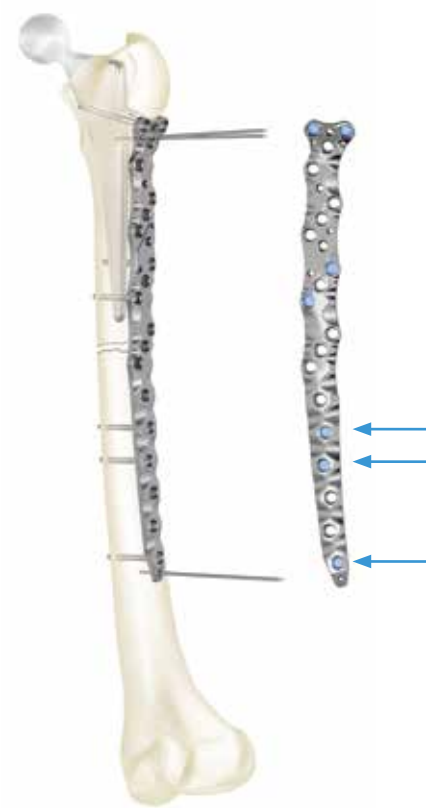

At least three bicortical *NCB* Screws inserted distal to the fracture area and to the prosthesis



**Final View**

Additional *NCB* Screws inserted as necessary to provide optimal fixation and k-wires are removed

### Insertion of the NCB/ULS or cortical Screws (with NCB Periprosthetic Trochanter Plate)

The actual configuration should always be determined based on the fracture type and bone quality. For screw selection and the surgical procedure on how to insert a *NCB*, ULS or cortical Screw, please refer to pages 18–22.

**Note:** Ensure that existing other medical devices and their fixation and/or anchorage elements are not affected or damaged by drill bits, taps, or screws.

#### Insertion of the NCB Screws Proximally

**1.** Insert an *NCB* Screw into one of the two most proximal plate holes.

**Note:** The screw selection should be considered with respect to the thickness of the cortex. For thin cortex, start by drilling a pilot hole for a 4.0mm *NCB* Screw, and subsequently enlarge it for a 5.0mm *NCB* Screw, if space permits.

**Note:** Do not fully tighten the first screw as it may tilt the plate.

**2.** Insert the second *NCB* Screw in the next proximal screw hole of the plate. After the second screw is inserted in the proximal screw hole, then both screws can be tightened.

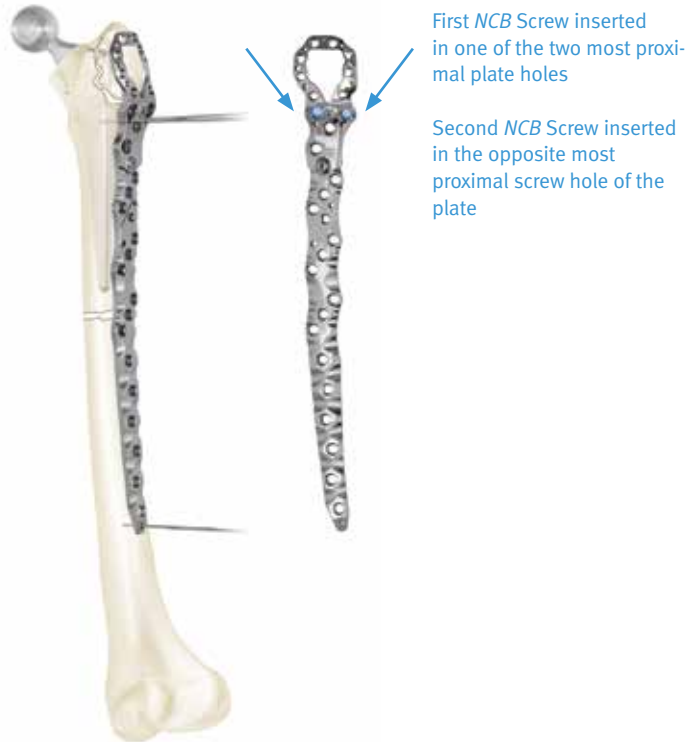

**Note:** Screws should not be locked until the distal fragment has been fixed.

**Insertion of the NCB Screws along the Shaft**

**3.** Insert the third *NCB* Screw anterior or posterior to the prosthesis in a diagonal three hole pattern along the femur shaft and proximal to the fracture.

**4.** Insert the fourth *NCB* Screw in the opposite hole of the same diagonal three hole pattern, creating a grip around the prosthesis.

**Note:** Bicortical screw fixation of at least four screws alternating anterior and posterior to the prosthesis is recommended.

If there is not enough cortex for two bicortical screws around the prosthesis in the same diagonal three hole pattern, insert one screw bicortically and one 5.0mm *NCB* Unicortical Screw in the central hole, to provide stability.

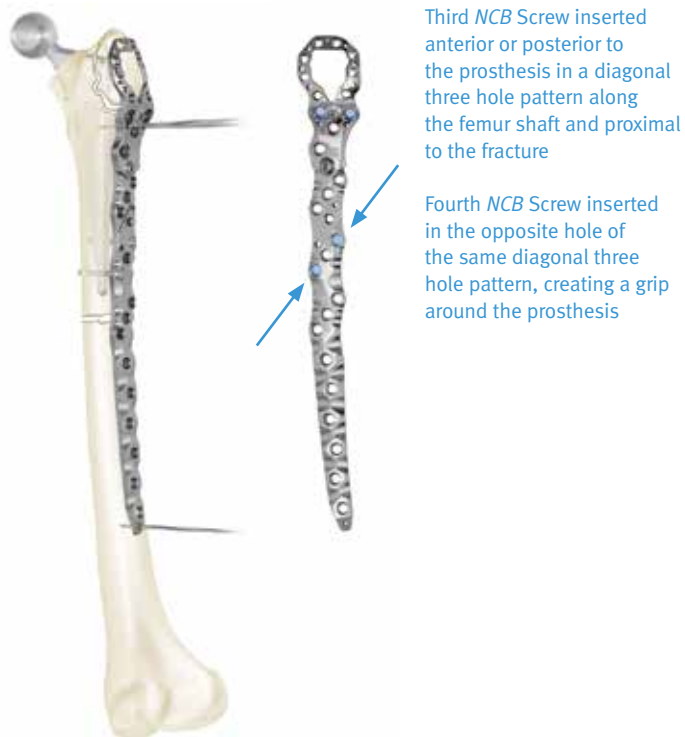

**Insertion of the NCB Screws Distally**

Insert at least three bicortical *NCB* Screws distal to the fracture area and to the prosthesis.

**Insertion of additional NCB Screws**

Insert additional *NCB* Screws as necessary to provide optimal fixation and remove the k-wires.

If screws are not enough, cables can be added.

See page 12 for cable fixation options and instructions.

**Note:** If adding cables to the *NCB* screw holes of the *NCB* Periprosthetic Trochanter plate, ensure that only the compatible blue *NCB* Cable Button (REF 47-2232-060-01) is used. See page 7 for details.

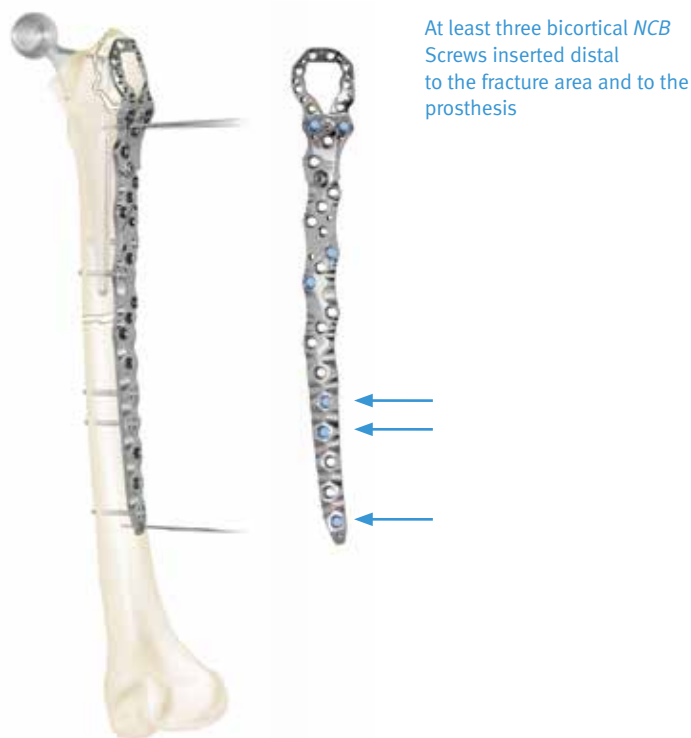

### Insertion of the ULS Screws or cortical screws into the NCB Periprosthetic Trochanter Plate

1. Insert a 3.5mm screw (locking or non-locking) into one of the two most proximal screw holes of the plate.
2. Insert the second 3.5mm screw (locking or non-locking) in the next proximal screw hole of the Trochanter Plate.
3. Insert additional 3.5mm screws on the anterior or posterior side of the NCB Periprosthetic Trochanter Plate if necessary.
4. Place additional screws close to the fracture zone.

**Surgical Technique Tip:** If you are using a Cable, tighten the cable before placing additional 3.5mm screws in NCB Periprosthetic Trochanter Plate.



#### Final View

Additional 3.5mm screws inserted as necessary to provide optimal fixation and k-wires are removed



## NCB Periprosthetic Distal Femur Plate – Surgical Technique

### Preoperative Planning and Patient Positioning

#### Preoperative Planning

Preoperative planning with adequate x-rays and x-ray templates for the *NCB* Periprosthetic Distal Femur Plate (Lit 06.02025.000) is strongly recommended.

This allows for determination of the proper plate length, and the appropriate type and position of screws, particularly in the presence of a knee prosthesis to prevent any interference with the knee stem.

Determine which prosthesis has been implanted by studying the x-rays, or using the previous surgeon's operative notes to be prepared in case of revision, and assess the stability of the prosthesis. If the prosthesis is loose, the surgical plan may change to include revision.

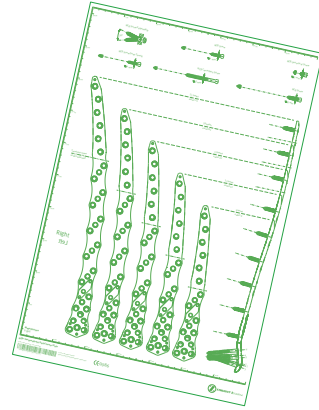

#### Patient Positioning

Lay the patient in the lateral position or the supine position on a radiolucent table. Support the knee, but allow the leg to move freely. Perform the reduction as necessary.

If intra-op fluoro is to be used, ensure the fluoro machine is not blocked by radioopaque bars of the operating table.

Patient in the lateral position

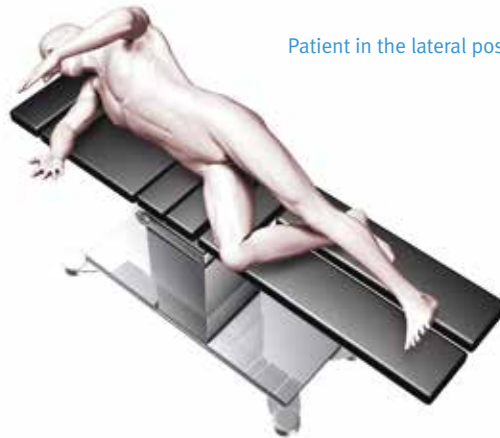

Patient in the supine position



## Incision and Intra-operative Planning

**Note:** Check to see if the prosthesis is loose before reduction. If the prosthesis is loose, revision may be indicated.

### Incision

A lateral incision is recommended. The skin incision should start at Gerdy's tubercle and continue proximally to expose the fracture zone. Alternatively, incorporate the existing incision, if applicable. The muscles should be left attached to the fracture fragments for optimal blood supply. Do not strip the periosteum.

### Intra-operative Planning

Take complete x-rays of the femur in the A/P and lateral views, occasional if necessary in the contra-lateral view, or a CT if osteolysis is present, to determine the length of the prosthesis, as well as the correct plate length to be implanted. Please refer to pages 14–16.

**Note:** The prosthesis length as well as the fracture location should determine the plate length, with the length of the patient's bone as a secondary guide. If the length of the prosthesis is between two plate sizes, choose the longer one.

If desired, the NCB Periprosthetic Distal Femur Plate Provisionals (REF 02.00024.35x) can be used to determine the suitable implant length. Provisionals are semi radiolucent and intended to be used in the open technique.

Each provisional represents the implant sizes it is labeled for, e.g. 12 holes. To use the provisional for the next shorter implant size (e.g. 9 hole plate), two square holes are included:

- the distal square hole indicates the end of the periprosthetic zone
- the proximal square hole indicates the most proximal NCB Screw hole of the next shorter implant size.

### Warning:

Do not implant or bend the provisional.



Incision



Excessive stripping of the soft tissue avoided and periosteum kept intact

NCB Periprosthetic Distal Femur Plate Provisional used for intra-operative planning (optional)

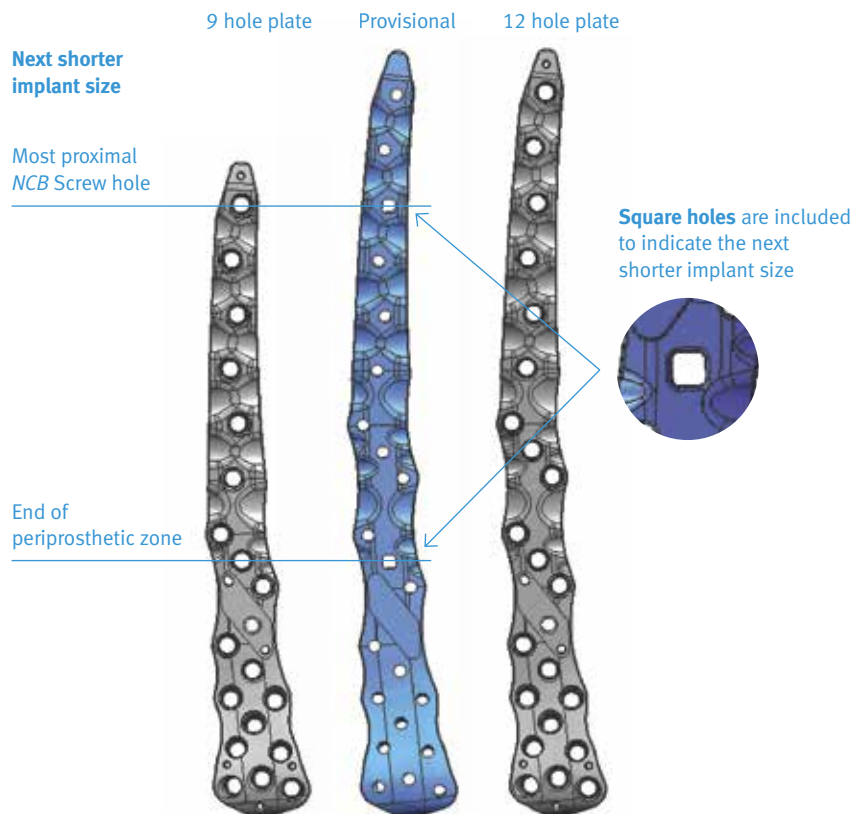

### Reduction and Preliminary Fixation

Reduce the fracture prior to inserting the plate. Bone fragments can be secured with 2.0mm k-wires (REF 290.20.280) or clamps such as pointed reduction forceps. Make sure that preliminary fixation devices do not interfere with the future location of the plate and screws, or with the prosthesis.

### Insertion of the NCB Periprosthetic Distal Femur Plate

Insert the appropriate left or right *NCB* Periprosthetic Distal Femur plate between the vastus lateralis muscle and the periosteum. Keep the proximal end in continuous contact with the bone surface during insertion.

Place the distal end of the plate as distal as possible, center the plate on the bone shaft in the lateral view and temporarily fix the plate with two 2.0mm k-wires distally and one k-wire proximally (REF 290.20.280). Avoid hitting the prosthesis.

**Note:** The *NCB* Periprosthetic Distal Femur Plate is anatomically shaped. If additional contouring is required, use the Bending Press Inserts (REF 02.00024.315/6) and the corresponding Bending Press (REF 100.06.010).

Be aware that bending the plate may decrease its fatigue strength. Furthermore, the locking mechanism of the *NCB* Screw hole may be damaged and, therefore, may no longer function. Do not use a hole that has been altered by contouring for locking. If the plate is bent, the MIS guide cannot be used.



*NCB* Periprosthetic Distal Femur Plate temporarily fixed with 2.0mm k-wires distally and proximally

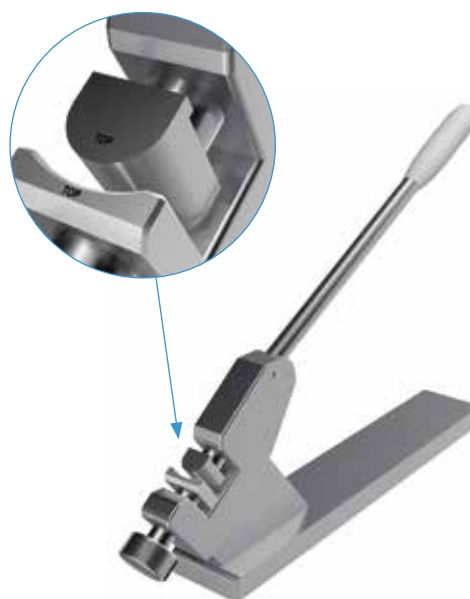

Correct orientation of the concave Bending Press insert: with the word "TOP" etched on the top of the insert

**Note:** The two distal k-wire holes are aligned at 95° to the plate shaft and are parallel to the most distal central screw hole to facilitate realignment of the shaft to the anatomic axis of the femur. It is very important that the plate maintains its position once it has been aligned with the joint.



**Optional**

4.3mm cannula for 95° screw insertion threaded into the most distal central *NCB* Screw hole of the *NCB* Periprosthetic Distal Femur Plate, to facilitate realignment of the femoral shaft to the joint.



### Insertion of the *NCB* Screws

The following configuration is one of many possibilities.

The actual configuration should always be determined based on the fracture type and bone quality. For screw selection and the instruction on how to insert a *NCB* Screw, please refer to pages 17–21.

**Note:** Ensure that existing intramedullary systems and their fixation and/or anchorage elements are not affected or damaged by drill bits, taps, or screws.

#### Insertion of the *NCB* Screws Distally

**1.** Insert a 5.0mm *NCB* Screw (cortical or cancellous) in the distal fragment. While tightening the first screw, ensure that the plate does not tilt.



First *NCB* Screw inserted in the distal fragment

Second *NCB* Screw inserted in the distal fragment



Optionally, the 4.3mm cannula for 95° screw insertion (REF 02.00024.320) can be used in the most distal central plate hole. For 5.0mm *NCB* Cancellous Screw insertion, the 2.5mm insert (REF 02.00024.321) should be placed inside the cannula. The drill path created by using these instruments should be parallel to the knee joint to aid in realigning the anatomic axis of the femur. The screw used in this hole should be locked immediately after insertion to maintain alignment.

**2.** Insert a second 5.0mm *NCB* Screw (cortical or cancellous) in the distal fragment.

**Note:** Except for the screw in the most distal central plate hole used to aid in realigning the anatomic axis of the femur, distal screws should not be locked until the proximal fragment has been fixed.

#### Insertion of the *NCB* Screws along the Shaft

**3.** Insert a third *NCB* Screw anterior or posterior to the prosthesis in a diagonal three hole pattern along the femur shaft and distal to the fracture.

**Note:** The screws should be chosen based on the thickness of the cortex. For thin cortical bone start by drilling a pilot hole for a 4.0mm *NCB* Screw, and subsequently enlarge it for a 5.0mm *NCB* Screw, if space permits.



Third *NCB* Screw inserted anterior or posterior to the prosthesis in a diagonal three hole pattern along the femur shaft and distal to the fracture

Fourth *NCB* Screw inserted in the opposite hole of the same diagonal three hole pattern, creating a grip around the prosthesis

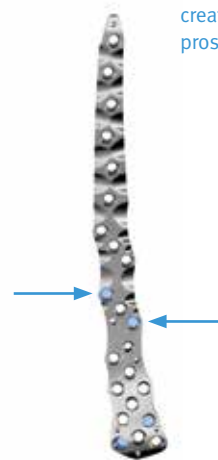

4. Insert the fourth *NCB* Screw in the opposite hole of the same diagonal three hole pattern, creating a grip around the prosthesis.

**Note:** Bicortical fixation of at least four screws alternating anterior and posterior to the prosthesis is recommended. If there is not enough cortex for two bicortical screws around the prosthesis in the same diagonal three hole pattern, insert one screw bicortically and one 5.0mm *NCB* Unicortical Screw in the central hole, to provide stability.

#### Insertion of the *NCB* Screws Proximally

Insert at least three bicortical *NCB* Screws proximal to the fracture area and to the prosthesis.

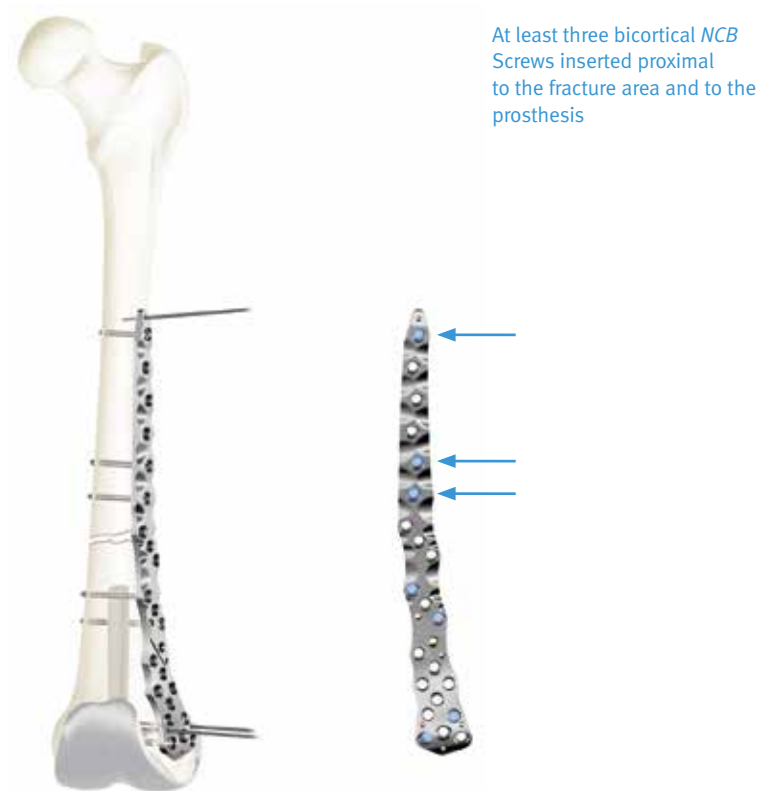

#### Insertion of Additional *NCB* Screws

Insert additional *NCB* Screws as necessary to provide optimal fixation and remove the k-wires.



## NCB Curved Femur Shaft Plate – Surgical Technique

### Preoperative Planning and Patient Positioning

#### Preoperative Planning

Preoperative planning with adequate x-rays and x-ray templates for the *NCB Curved Femur Shaft Plate* (Lit 06.02026.000) is strongly recommended.

This allows determination of the proper plate length, and the appropriate type and position of screws, particularly in the presence of prosthesis to prevent any interference with the stem.

Determine which prosthesis has been implanted by studying the x-rays, or using the previous surgeon's operative notes to be prepared in case of revision, and assess the stability of the prosthesis. If the prosthesis is loose, the surgical plan may change to include revision.

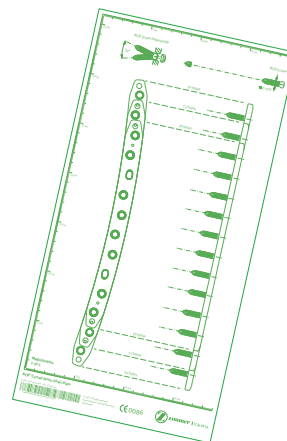

#### Patient Positioning

Lay the patient in the lateral position or the supine position on a radiolucent table. Support the knee, but allow the leg to move freely. Perform the reduction as necessary.

If intra-op fluoro is to be used, ensure the fluoro machine is not blocked by radioopaque bars of the operating table.

Patient in the lateral position

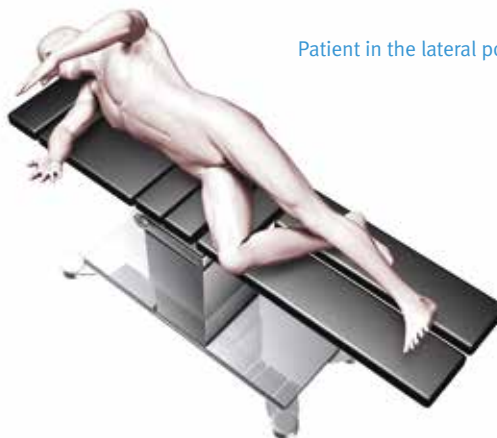

Patient in the supine position

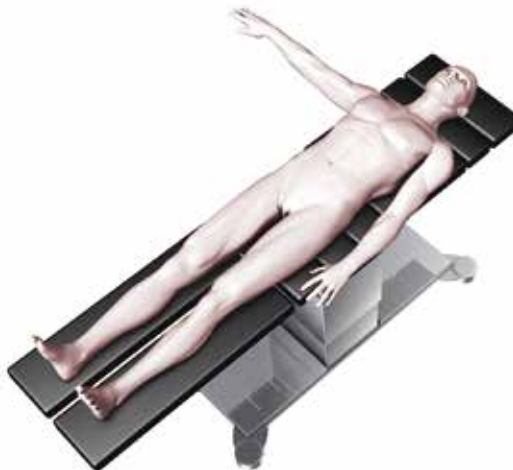

## Incision and Intra-operative Planning

### Incision

Make the incision using the lateral subvastus approach or incorporate the existing incision, if applicable. Avoid excessive stripping of the soft tissues and keep the periosteum intact.

### Intra-operative Planning

Take complete x-rays of the femur in the A/P and lateral view and if necessary, also in the contra-lateral view, or a CT if osteolysis is present to determine the length of the prosthesis, as well as the correct plate length to be implanted.

If desired, the *NCB Curved Femur Shaft Plate Provisional* (REF 02.00024.358) can be used to determine the suitable implant length. Provisional is semi radio-lucent and intended to be used in the open technique.

There is only one provisional which represents the 12 hole *NCB Curved Femur Shaft Plate*. To use the provisional for the next shorter implant size (10 hole plate), two square holes are included:

- the proximal square hole indicates the most proximal *NCB Plate* hole of the next shorter implant size
- the distal square hole indicates the most distal *NCB Plate* hole of the next shorter implant size.

### Warning:

Do not implant or bend the provisional.



Incision



Excessive stripping of the soft tissue avoided and periosteum kept intact

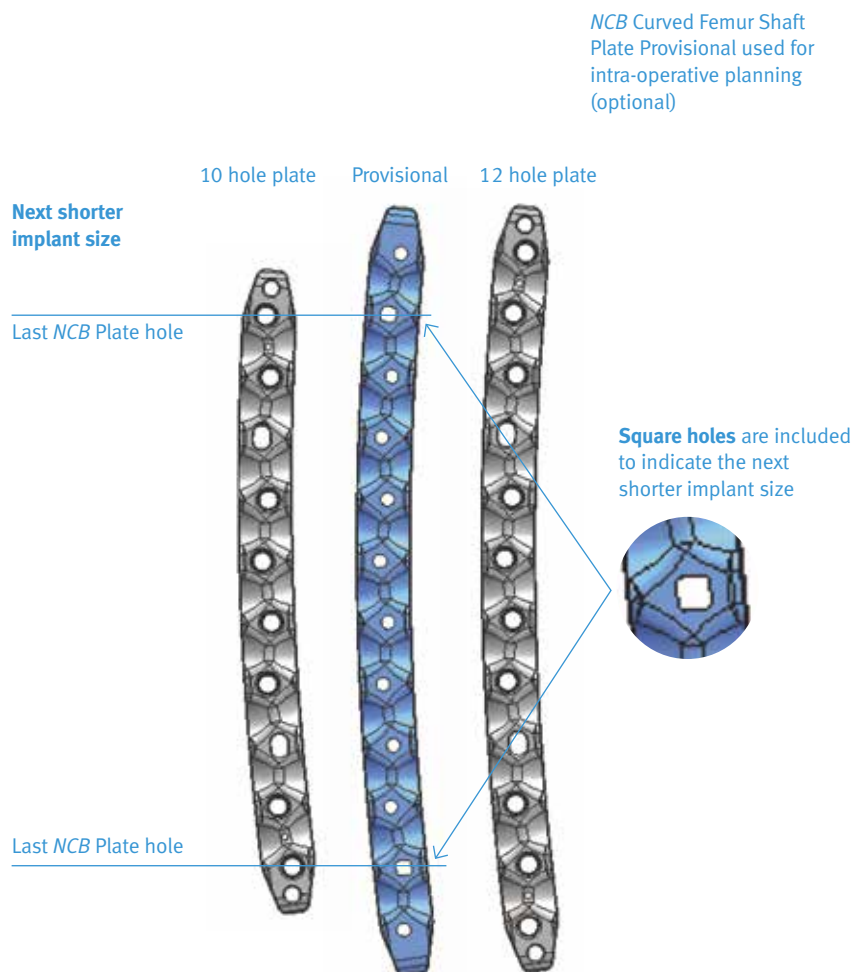

*NCB Curved Femur Shaft Plate Provisional* used for intra-operative planning (optional)



### Reduction and Preliminary Fixation

Reduce the fracture prior to inserting the plate. Bone fragments can be secured with 2.0mm k-wires (REF 290.20.280) or clamps such as pointed reduction forceps. Make sure that preliminary fixation devices do not interfere with the future location of the plate and screws, or with the prosthesis.

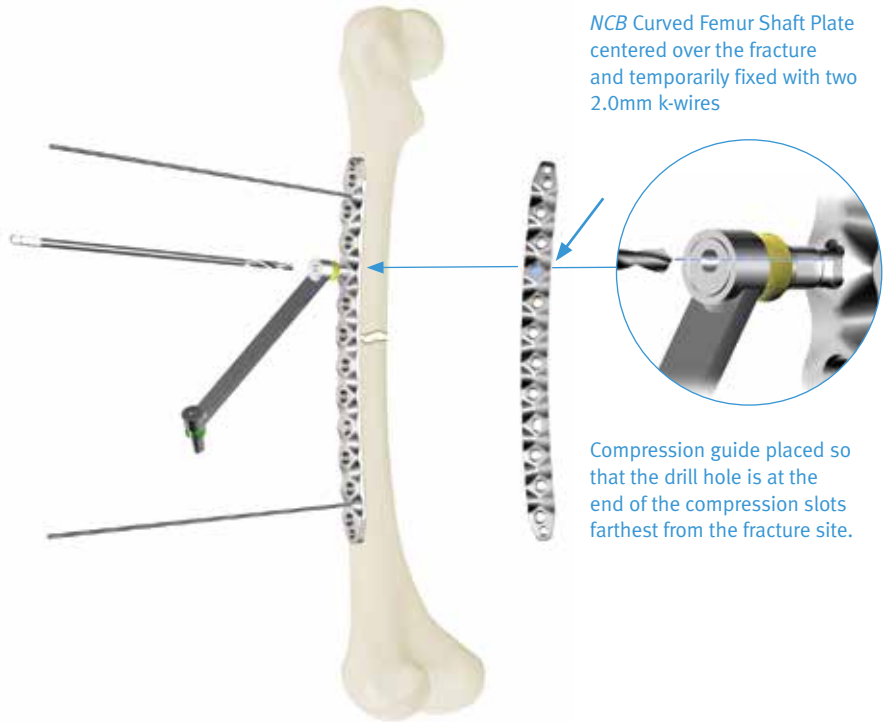

### Insertion of the NCB Curved Femur Shaft Plate

The following example shows a case without a prosthesis.

The NCB Curved Femur Shaft Plate is placed on the lateral femur centered over the fracture.

Temporarily fix the plate with two 2.0mm k-wires (REF 290.20.280), one proximally and one distally.

#### Note:

The NCB Curved Femur Shaft Plate is anatomically shaped. If additional contouring is required, use the Bending Press Inserts (REF 02.00024.315/6) and the corresponding Bending Press (REF 100.06.010).

Be aware that bending the plate may decrease its fatigue strength. Furthermore, the locking mechanism of the NCB Screw hole may be damaged and, therefore, may no longer function. Do not use a hole that has been altered by contouring for locking.

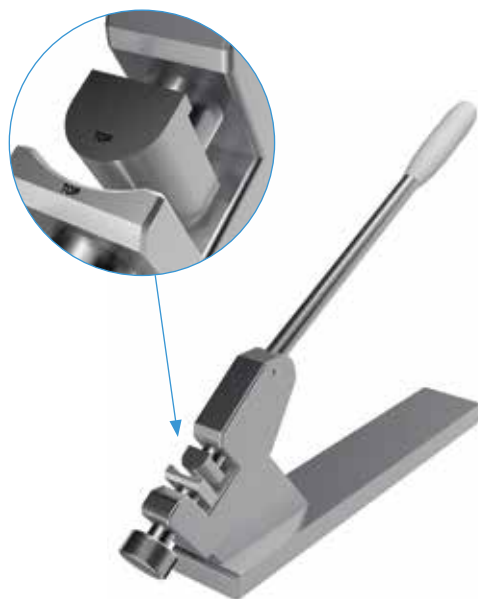

## Insertion of the NCB Screws

The *NCB* Curved Femur Shaft Plate has two compression slots to allow for axial adjustment while positioning the plate, as well as for axial compression.

**Note:** It is possible to get 1 or 2mm of axial compression with the *NCB* Curved Femur Shaft Plate. For 2mm of compression, insert the *NCB* Screws into the compression holes first (like in the example shown in this surgical technique). For 1mm of compression, insert a *NCB* Screw into a *NCB* Plate hole, and then use the compression slot on the opposite side of the fracture. If more compression is needed, use the Articulated Tension Device\* (REF 00-4817-005-00) after only one side of the plate has been fixed. This instrument can be attached to the bone, using a 4.0mm *NCB* Screw.

For screw selection and insertion, please refer to pages 17–21.

**Note:** Screws should not be locked until both sides of the fragment have been fixed.

1. For 2.0mm of axial compression, drill the first hole in one of the two compression slots in the compression position using the *NCB* Compression Drill Guide for 5.0mm *NCB* Screws (REF 02.00024.335) and the 4.3mm drill bit (REF 02.00024.002). Place the compression guide so that the drill hole is at the end of the compression slots farthest from the fracture site. Partially insert a 5.0mm *NCB* Screw into the compression slot but do not tighten it.

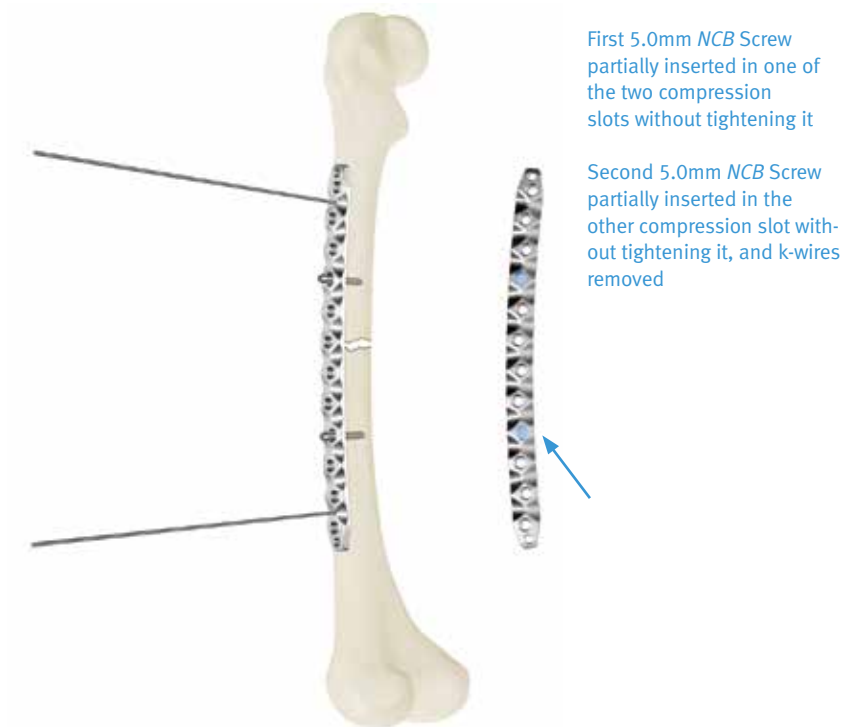

\* Not included in *NCB* Periprosthetic Femur instrument set.

**2.** Partially insert a 5.0mm *NCB* Screw into the other compression slot, also in the compression position, but do not tighten it.

**3.** Remove the two 2.0mm k-wires.  
To achieve axial compression, tighten the *NCB* Screws in the two compression slots by using the *NCB* Hexagonal Screwdriver (REF 02.00024.023).

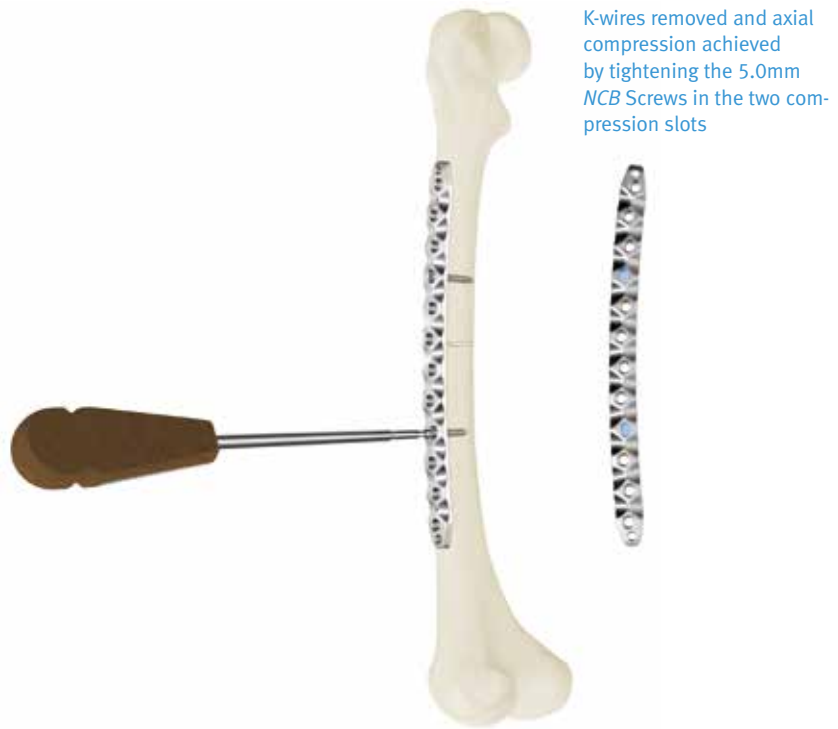

**4.** Insert additional 5.0mm *NCB* Screws as necessary, first near the fracture site and then proximal/distal to the fracture, ensuring purchase in a minimum of six cortices on each side of the fracture, spaced on the entire length of the plate.

If desired, slightly loosen the 5.0mm *NCB* Screws in the two compression slots to avoid contact between the plate and the bone.

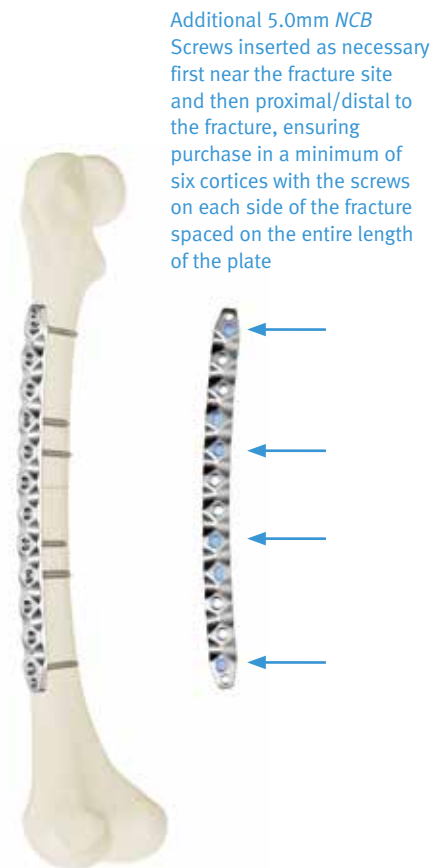

## NCB Bone Spacers (Optional)

Use at least two bone spacers in the diaphyseal area of all *NCB* Plates, to avoid contact of the plate with the bone surface reducing the risk of periosteal blood supply impairment.

The spacers may also be used if the fracture has been reduced using a cable, to avoid contact between the plate and the cable.

The spacers are available in 1mm, 2mm and 3mm (REF 02.03150.311 to 313) sizes.

**Note:** Insert the bone spacers into the *NCB* Screw holes before plate insertion. The spacers are single use only, and they can be removed after locking the screws.

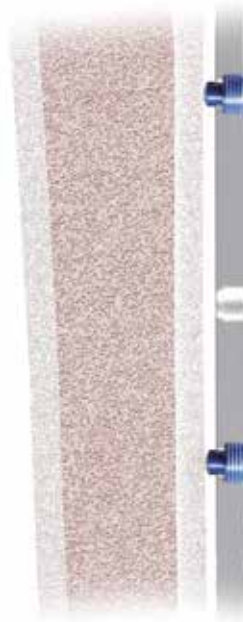

Two *NCB* Bone Spacers used in the diaphyseal area of a *NCB* Plate, to avoid contact of the plate with the bone (Non Contact Bridging)



Spacer 1 to 3 mm

## NCB Blind Screw Inserts (Optional)

To prevent bone ingrowth into empty *NCB* Screw holes, use the *NCB* Blind Screw Inserts (REF 02.03150.310).

**Note:** Hand tighten only.



*NCB* Blind Screws inserted in a *NCB* Plate to prevent bone ingrowth



Blind Screw Insert

## Tips and Tricks for the NCB Periprosthetic Femur System

### Drilling into Cement Mantle

In patients with cemented prostheses, the insertion of screws may occur in the presence of a cement mantle. This can cause cracks, which may cause loosening of the prosthesis. Be careful not to hit the prosthesis when tapping, drilling and inserting screws.

#### Tips, which may Mitigate this Risk

- Use a lower speed for drilling into the cement mantle to prevent overheating and avoid cement melting
- Use a higher feed rate (increased drill force)
- Use only new sharp drill bits. Change drills frequently and do not use worn ones
- Titanium nitride coated (gold) drill bits are available:
  - 3.0mm drill bit (REF 02.00024.301)
  - 3.5mm drill bit (REF 02.00024.325)
  - 4.5mm drill bit (REF 02.00024.330)
- Use taps
- Overdrilling by using drill bits of a slightly larger diameter (0.2mm) may reduce cracking in the cement mantle during screw insertion. In the *NCB Periprosthetic Femur* set a 3.5mm drill bit (REF 02.00024.325) can be used in place of the 3.3mm drill bit, and a 4.5mm drill bit (REF 02.00024.330) can be used in place of the 4.3mm drill bit. These drill bits are offered together with their corresponding drill guides.

**Note:** Overdrilling the cement mantle by 0.2mm does reduce pull out strength by about 20%. However, within the cement mantle pull out strength is still more than 2000 N.<sup>4</sup>

### Drilling into Cortical Bone

In order to go around the stem of the prosthesis and achieve bicortical fixation with the offset holes of the diagonal three hole pattern, it may be necessary to drill completely into cortical bone, which can lead to heat necrosis of the bone.

**Warning:** Drilling and inserting screws into the outer edge of the cortical bone may also lead to cortical fracture.

#### Tips, which may Mitigate these Risks

- Use only new sharp drill bits. Change drills frequently and do not use worn ones
- Pull the drill bit out often and clean its flutes
- Use extensive irrigating fluid (i.e. saline water) directed at the point of penetration of the cortex
- Use taps
- In patients with thin cortical bone, away from the fracture area, use *NCB* screws of a smaller diameter like the 4.0mm *NCB* Screws, or the 4.0mm *NCB* Deep Thread Screws.

### Metal Abrasion Wear

Metal abrasion wear due to contact between screws, plates, prostheses, cable buttons, and cables may occur.

#### Tip, which may Mitigate this Risk

Use only Zimmer products compatible with the *NCB Periprosthetic Femur System*, which are described in this surgical technique.

<sup>4</sup> J. Kampshoff et al.: The treatment of periprosthetic fractures with locking plates: effect of drill and screw type on cement mantles: a biomechanical analysis, Archives of Orthopedic and Trauma Surgery, Springer, March 2009.

## Implant Removal

To remove the *NCB* Periprosthetic Proximal Femur, Distal Femur, and Curved Femur Shaft Plates, first remove all locking caps (REF 02.03150.300). Then, loosen all the *NCB* Screws without completely removing them (this prevents rotation of the bone plate when removing the last screw). Finally, completely remove all *NCB* Screws.

**Note:** Make sure that the tip of the *NCB* Hexagonal Screwdriver (REF 02.00024.023) is correctly placed in the hex drive of the locking caps and/or *NCB* Screws. Failure to do so could damage the hex drive and complicate the extraction of the implant.

### Removal Tip

In case of difficulties while loosening the *NCB* Screws, tighten the screws slightly before loosening them.

It is possible to remove only the *NCB* Periprosthetic Trochanter Plate and leave the *NCB* Periprosthetic Proximal Femur Plate in place. Do not forget to remove the two connection screws using the 3.5mm Hex screwdriver.

## Product Information – Implants

### Plates

#### NCB Periprosthetic Proximal Femur Plates, Ti6Al4V Right

REF	REF Sterile	Holes	Length mm
—	02.02263.000	N/A	115
02.03263.009	02.02263.009	9	245
02.03263.012	02.02263.012	12	285
02.03263.015	02.02263.015	15	324
02.03263.018	02.02263.018	18	363
02.03263.021	02.02263.021	21	401

#### Left

REF	REF Sterile	Holes	Length mm
—	02.02263.100	N/A	115
02.03263.109	02.02263.109	9	245
02.03263.112	02.02263.112	12	285
02.03263.115	02.02263.115	15	324
02.03263.118	02.02263.118	18	363
02.03263.121	02.02263.121	21	401

#### NCB Periprosthetic Trochanter Plates\*, Ti6Al4V

REF	REF Sterile	Size
—	02.02263.201	right narrow
—	02.02263.202	right wide
—	02.02263.301	left narrow
—	02.02263.302	left wide

#### Connection Screw for NCB Periprosthetic Trochanter Plate, Ti6Al4V

REF	REF Sterile
—	02.02266.002

#### NCB Periprosthetic Distal Femur Plates, Ti6Al4V Right

REF	REF Sterile	Holes	Length mm
02.03264.009	02.02264.009	9	238
02.03264.012	02.02264.012	12	278
02.03264.015	02.02264.015	15	317
02.03264.018	02.02264.018	18	355
02.03264.021	02.02264.021	21	393

#### Left

REF	REF Sterile	Holes	Length mm
02.03264.109	02.02264.109	9	238
02.03264.112	02.02264.112	12	278
02.03264.115	02.02264.115	15	317
02.03264.118	02.02264.118	18	355
02.03264.121	02.02264.121	21	393

#### NCB Curved Femur Shaft Plates, Ti6Al4V

REF	REF Sterile	Holes	Length mm
02.03265.010	02.02265.010	10	210
02.03265.012	02.02265.012	12	249
02.03265.014	02.02265.014	14	289



#### Materials

NCB Periprosthetic Plates and Screws are made of Ti6Al4V, ISO 5832-3, ASTM F136

\* The NCB Periprosthetic Trochanter Plate is packed together with two connection screws which are preassembled.

## Screws

### NCB Locking Caps, Spacers, Blind Screw Inserts, Ti6Al4V

REF	REF Sterile	Description
02.03150.300	02.02150.300	Locking cap
02.03150.310	02.02150.310	Blind screw insert
02.03150.311	02.02150.311	Spacer 1mm
02.03150.312	02.02150.312	Spacer 2mm
02.03150.313	02.02150.313	Spacer 3mm

### NCB Screws, Ø 5.0mm, Ti6Al4V

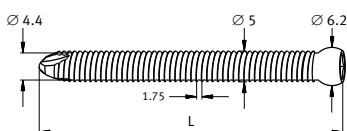

REF	REF Sterile	Length mm
02.03150.022	02.02150.022	22
02.03150.024	02.02150.024	24
02.03150.026	02.02150.026	26
02.03150.028	02.02150.028	28
02.03150.030	02.02150.030	30
02.03150.032	02.02150.032	32
02.03150.034	02.02150.034	34
02.03150.036	02.02150.036	36
02.03150.038	02.02150.038	38
02.03150.040	02.02150.040	40
02.03150.042	02.02150.042	42
02.03150.044	02.02150.044	44
02.03150.046	02.02150.046	46
02.03150.048	02.02150.048	48
02.03150.050	02.02150.050	50
02.03150.055	02.02150.055	55
02.03150.060	02.02150.060	60
02.03150.065	02.02150.065	65
02.03150.070	02.02150.070	70
02.03150.075	02.02150.075	75
02.03150.080	02.02150.080	80
02.03150.085	02.02150.085	85
02.03150.090	02.02150.090	90
02.03150.095	02.02150.095	95
02.03150.100	02.02150.100	100

### NCB Unicortical Screws, Ø 5.0mm, Ti6Al4V

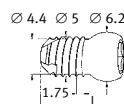

REF	REF Sterile	Length mm
02.03151.010	02.02151.010	10
02.03151.012	02.02151.012	12
02.03151.014	02.02151.014	14
02.03151.016	02.02151.016	16
02.03151.018	02.02151.018	18
02.03151.020	02.02151.020	20

### NCB Cancellous Screws, Ø 5.0mm, 32mm Thread Ti6Al4V

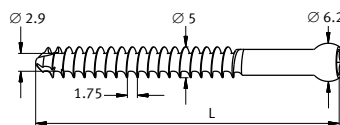

REF	REF Sterile	Length mm
02.03152.050	02.02152.050	50
02.03152.055	02.02152.055	55
02.03152.060	02.02152.060	60
02.03152.065	02.02152.065	65
02.03152.070	02.02152.070	70
02.03152.075	02.02152.075	75
02.03152.080	02.02152.080	80
02.03152.085	02.02152.085	85
02.03152.090	02.02152.090	90
02.03152.095	02.02152.095	95
02.03152.100	02.02152.100	100

#### Materials

NCB Periprosthetic Plates, Screws, Locking Caps, Spacers, and Blind Screw Inserts are made of Ti6Al4V, ISO 5832-3, ASTM F136



**NCB Screws, Ø 4.0mm  
Ti6Al4V**

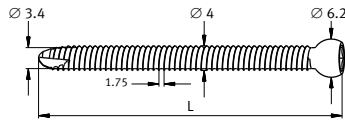

REF	REF Sterile	Length mm
02.03155.020	02.02155.020	20
02.03155.022	02.02155.022	22
02.03155.024	02.02155.024	24
02.03155.026	02.02155.026	26
02.03155.028	02.02155.028	28
02.03155.030	02.02155.030	30
02.03155.032	02.02155.032	32
02.03155.034	02.02155.034	34
02.03155.036	02.02155.036	36
02.03155.038	02.02155.038	38
02.03155.040	02.02155.040	40
02.03155.042	02.02155.042	42
02.03155.044	02.02155.044	44
02.03155.046	02.02155.046	46
02.03155.048	02.02155.048	48
02.03155.050	02.02155.050	50
02.03155.055	02.02155.055	55
02.03155.060	02.02155.060	60
02.03155.065	02.02155.065	65

**NCB Screws Ø 4.0mm, Deep Thread,  
Ti6Al4V**

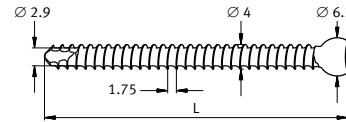

REF	REF Sterile	Length mm
02.03154.020	02.02154.020	20
02.03154.022	02.02154.022	22
02.03154.024	02.02154.024	24
02.03154.026	02.02154.026	26
02.03154.028	02.02154.028	28
02.03154.030	02.02154.030	30
02.03154.032	02.02154.032	32
02.03154.034	02.02154.034	34
02.03154.036	02.02154.036	36
02.03154.038	02.02154.038	38
02.03154.040	02.02154.040	40
02.03154.042	02.02154.042	42
02.03154.044	02.02154.044	44
02.03154.046	02.02154.046	46
02.03154.048	02.02154.048	48
02.03154.050	02.02154.050	50
02.03154.055	02.02154.055	55
02.03154.060	02.02154.060	60
02.03154.065	02.02154.065	65

**ULS Screws Ø 3.5mm, Locking  
Ti6Al4V**

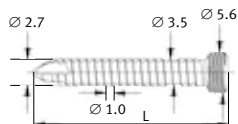

REF	REF Sterile	Length mm
00-2369-012-35	47-2369-012-35	12
00-2369-014-35	47-2369-014-35	14
00-2369-016-35	47-2369-016-35	16
00-2369-018-35	47-2369-018-35	18
00-2369-020-35	47-2369-020-35	20
00-2369-022-35	47-2369-022-35	22
00-2369-024-35	47-2369-024-35	24
00-2369-026-35	47-2369-026-35	26
00-2369-028-35	47-2369-028-35	28
00-2369-030-35	47-2369-030-35	30
00-2369-032-35	47-2369-032-35	32
00-2369-034-35	47-2369-034-35	34
00-2369-036-35	47-2369-036-35	36
00-2369-038-35	47-2369-038-35	38
00-2369-040-35	47-2369-040-35	40
00-2369-042-35	47-2369-042-35	42
00-2369-044-35	47-2369-044-35	44
00-2369-046-35	47-2369-046-35	46
00-2369-048-35	47-2369-048-35	48
00-2369-050-35	47-2369-050-35	50
00-2369-052-35	47-2369-052-35	52
00-2369-054-35	47-2369-054-35	54
00-2369-056-35	47-2369-056-35	56
00-2369-058-35	47-2369-058-35	58
00-2369-060-35	47-2369-060-35	60

**ULS Screws Ø 3.5mm, Cortical  
Ti6Al4V**

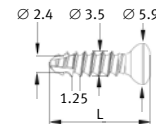

REF	REF Sterile	Length mm
00-4935-012-01	47-4935-012-01	12
00-4935-014-01	47-4935-014-01	14
00-4935-016-01	47-4935-016-01	16
00-4935-018-01	47-4935-018-01	18
00-4935-020-01	47-4935-020-01	20
00-4935-022-01	47-4935-022-01	22
00-4935-024-01	47-4935-024-01	24
00-4935-026-01	47-4935-026-01	26
00-4935-028-01	47-4935-028-01	28
00-4935-030-01	47-4935-030-01	30
00-4935-032-01	47-4935-032-01	32
00-4935-034-01	47-4935-034-01	34
00-4935-036-01	47-4935-036-01	36
00-4935-038-01	47-4935-038-01	38
00-4935-040-01	47-4935-040-01	40
00-4935-045-01	47-4935-045-01	45
00-4935-050-01	47-4935-050-01	50
00-4935-055-01	47-4935-055-01	55
00-4935-060-01	47-4935-060-01	60

**Materials**

NCB Screws and ULS Screws are made of Ti6Al4V, ISO 5832-3, ASTM F136.

### Cortical Screws, $\varnothing$ 3.5mm (EMEA only), Ti6Al7Nb

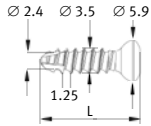

REF	REF Sterile	Length mm
02.03131.012	–	12
02.03131.014	–	14
02.03131.016	–	16
02.03131.018	–	18
02.03131.020	–	20
02.03131.022	–	22
02.03131.024	–	24
02.03131.026	–	26
02.03131.028	–	28
02.03131.030	–	30
02.03131.032	–	32
02.03131.034	–	34
02.03131.036	–	36
02.03131.038	–	38
02.03131.040	–	40
02.03131.045	–	45
02.03131.050	–	50
02.03131.055	–	55
02.03131.060	–	60

### \*\*NCB MotionLoc Screws, $\varnothing$ 5.0mm Cortical, Self Tapping, Ti6Al4V

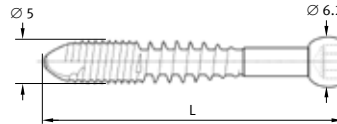

REF	REF Sterile	Length mm
02.03161.030	02.02161.030	30
02.03161.032	02.02161.032	32
02.03161.034	02.02161.034	34
02.03161.036	02.02161.036	36
02.03161.038	02.02161.038	38
02.03161.040	02.02161.040	40
02.03161.042	02.02161.042	42
02.03161.044	02.02161.044	44
02.03161.046	02.02161.046	46
02.03161.048	02.02161.048	48
02.03161.050	02.02161.050	50
02.03161.052	02.02161.052	52
02.03161.054	02.02161.054	54
02.03161.056	02.02161.056	56
02.03161.058	02.02161.058	58
02.03161.060	02.02161.060	60

### Compatible Zimmer Products with the NCB Periprosthetic Femur System

REF sterile	Description
47-2232-060-00*	NCB Polyaxial Locking Plate Cable Button, Gold, 2.5mm Hex Drive, Material: Ti6Al4V
47-2232-060-01	NCB Polyaxial Locking Plate Cable Button, Blue, 2.5mm Hex Drive, Material: Ti6Al4V
00-2232-002-35	Hex Buttons, 3.5mm Hex, Material: C.P. Titanium
00-2232-002-28	Cable-Ready Cable Assembly Cerclage, $\varnothing$ 1.8mm, L. 914mm, Material: CoCr
00-2232-004-18	Cable-Ready Cable Assembly Cerclage, $\varnothing$ 1.8mm, L. 635mm, Material: CoCr

#### Materials

3.5mm Cortical Screws are made of Ti6Al7Nb, ISO 5832-11, ASTM F1295;  
the NCB Screws are made of Ti6Al4V, ISO 5832-3, ASTM F136.

\* Not available in Europe, Middle East, and Africa

\*\* MotionLoc screws are compatible with the NCB PP Femur plates only in United States (US), Australia/New Zealand, Canada, European Union (EU), European Free Trade Association (EFTA), South Korea, Singapore, Taiwan and Thailand

## Product Information – Instruments

### Standard Instruments

#### NCB Periprosthetic Femur Standard Instruments

REF	Description
02.00024.002	NCB Drill Bit Ø 4.3mm, L. 195mm
02.00024.005	NCB Measuring Device, L. 110mm
02.00024.010	NCB Drill Guide Ø 2.5mm
02.00024.011	NCB Drill Guide Ø 4.3mm
02.00024.021	NCB DF Torque Screwdriver, 6Nm, L. 280mm
02.00024.023	NCB Hexagonal Screwdriver for femur SW 3.5
02.00024.024	NCB Hexagonal Screwdriver shaft SW 3.5
02.00024.111	NCB Drill Guide Ø 3.3mm for screws Ø 4.0/4.5mm
02.00024.118	NCB Drill Bit Ø 3.3mm, with quick coupling L. 195mm
02.00024.121	NCB Locking screw holder for hexagonal screwdriver 3.5mm
02.00024.315	Bending press insert, concave
02.00024.316	Bending press insert, convex
02.00024.320	NCB Periprosthetic cannula Ø 4.3mm for 95° screw insertion
02.00024.321	NCB Periprosthetic insert Ø 2.5mm, for use with 4.3mm cannula
02.00024.335	NCB Compression Drill Guide for 5.0mm screws
02.00024.340	NCB Tap Ø 4.0mm, with quick coupling, L. 250mm
02.00024.341	NCB Tap Ø 5.0mm, with quick coupling, L. 250mm
02.00024.364	NCB Plate Inserter with 2mm cannulation
100.90.005	Self-holding screw forceps
100.90.210	T-handle with quick coupling for taps
103.25.180	Two-fluted drill bit Ø 2.5mm, with quick coupling, L. 154/180mm
109.01.020	Small hexagonal screwdriver without holding sleeve, hexagon 2.5mm
290.20.280	Kirschner wire with trocar tip Ø 2mm, L. 280mm

#### NCB Periprosthetic Trochanter Standard Instruments

REF	Description
00-4806-110-25	Drill Bit, Q/C, Ø 2.5mm, L. 110mm
00-4806-110-35	Drill Bit, Q/C, Ø 3.5mm, L. 110mm
00-4808-035-01	3.5mm/2.5mm Double Drill Sleeve
00-4809-035-00	Countersink, Q/C, for 3.5mm and 4.0mm screws
00-4810-002-01	Small Depth Gauge for 2.7/3.5/4.0 screws to 60mm
00-4811-110-35	Tap Ø 3.5mm, with quick coupling, L. 110mm (for cortical screws)
00-4812-000-00	Screw holding forceps
00-4812-035-00	Small Hex Screwdriver, 2.5mm Hex
00-2360-165-25	Small Hex Screwdriver Shaft, with Q/C, 2.5mm Hex, 140mm
00-4812-035-05	Holding sleeve for small hexagonal screwdrivers
00-2360-020-27	2.7mm Drill Standard Cannula
00-2360-040-35	Locking Small Depth Gauge
00-2360-088-00	Cannula inserter
00-2360-205-27	2.7mm Standard Drill, QC, 205mm long
00-2360-153-35	Tap Ø 3.5mm, with quick coupling, L. 110mm (for locking screws)

## Optional Instruments

### NCB Instruments for NCB Screws, Ø 4mm, Deep Thread

REF	Description
02.00024.301	NCB Drill Bit Ø 3.0mm, with quick coupling, L. 195mm
02.00024.305	NCB Tap Ø 4.0mm, with quick coupling, for deep thread screw, L. 250mm
02.00024.310	NCB Drill Guide Ø 3.0mm

### NCB Instruments for Overdrilling into Cement for NCB Screws Ø 4.0mm and 5.0mm

REF	Description
02.00024.325	NCB Drill Bit Ø 3.5mm, with quick coupling, L. 195mm
02.00024.326	NCB Drill Guide Ø 3.5mm
02.00024.330	NCB Drill Bit Ø 4.5mm, with quick coupling, L. 195mm
02.00024.331	NCB Drill Guide Ø 4.5mm

### NCB Long Instruments

REF	Description
02.00024.340	NCB Tap Ø 4.0mm, with quick coupling, L. 250mm
02.00024.341	NCB Tap Ø 5.0mm, with quick coupling, L. 250mm
02.00024.342	NCB Drill Bit Ø 2.5mm, with quick coupling, L. 245mm
02.00024.343	NCB Drill Guide Ø 2.5mm, long
02.00024.344	NCB Drill Bit Ø 3.3mm, with quick coupling, L. 245mm
02.00024.345	NCB Drill Guide Ø 3.3mm, long
02.00024.346	NCB Drill Bit Ø 4.3mm, with quick coupling, L. 245mm
02.00024.347	NCB Drill Guide Ø 4.3mm, long
02.00024.348	NCB Periprosthetic cannula Ø 4.3mm for 95° screw insertion, long

### NCB Instruments for Lagging NCB Screws

REF	Description
02.00024.360	NCB Drill Bit Ø 4.0mm, with quick coupling, L. 245mm
02.00024.361	NCB Drill Guide Ø 4.0mm, long

### NCB Periprosthetic Femur Provisionals

REF	Description
02.00024.350	NCB Periprosthetic Proximal Femur Plate Provisional, right, 15/18 hole plates
02.00024.351	NCB Periprosthetic Proximal Femur Plate Provisional, left, 15/18 hole plates
02.00024.352	NCB Periprosthetic Proximal Femur Plate Provisional, right, 9/12 hole plates
02.00024.353	NCB Periprosthetic Proximal Femur Plate Provisional, left, 9/12 hole plates
02.00024.354	NCB Periprosthetic Distal Femur Plate Provisional, right, 15/18 hole plates
02.00024.355	NCB Periprosthetic Distal Femur Plate Provisional, left, 15/18 hole plates
02.00024.356	NCB Periprosthetic Distal Femur Plate Provisional, right, 9/12 hole plates
02.00024.357	NCB Periprosthetic Distal Femur Plate Provisional, left, 9/12 hole plates
02.00024.358	NCB Curved Femur Shaft Plate Provisional, 10/12/14 hole plates

### NCB Periprosthetic Trochanter Provisionals

REF	Description
02.00024.411	NCB Periprosthetic Trochanter Plate Provisional, narrow, right
02.00024.412	NCB Periprosthetic Trochanter Plate Provisional, narrow, left
02.00024.413	NCB Periprosthetic Trochanter Plate Provisional, wide, right
02.00024.414	NCB Periprosthetic Trochanter Plate Provisional, wide, left

## Sterile Instruments

REF	Description
02.02024.342	NCB Drill Bit Ø 2.5mm, with quick coupling, L=245mm
02.02024.344	NCB Drill Bit Ø 3.3mm, with quick coupling, L=245mm
02.02024.346	NCB Drill Bit Ø 4.3mm, with quick coupling, L=245mm
02.02024.360	NCB Drill Bit Ø 4.0mm, with quick coupling, L=245mm

## Graphic Cases for the NCB Periprosthetic Femur System

### Standard Graphic Cases

REF	Description
02.00024.901	NCB Periprosthetic Plate System, Femur Plates, base
02.00024.902	NCB Periprosthetic Plate System, Femur Screws and Instruments, base and trays
02.00024.903	NCB Periprosthetic Plate System, Femur Screws and Instruments, base
02.00024.904	NCB Periprosthetic Plate System, Femur Screws and Instruments, standard screw caddy
02.00024.905	NCB Periprosthetic Plate System, Femur Screws and Instruments, deep thread screw caddy
02.00024.906	NCB Periprosthetic Plate System, Femur Screws and Instruments, tray
02.00024.907	NCB Periprosthetic Plate System, Femur Screws and Instruments, locking caps and spacers
02.00024.930	NCB Periprosthetic Trochanter Plate, Add-On set
02.00024.931	NCB Periprosthetic Trochanter Plate, Add-On set, base
02.00024.932	NCB Periprosthetic Trochanter Plate, Add-On set, screw caddy
02.00024.933	NCB Periprosthetic Trochanter Plate, Add-On set, top tray
02.00024.934	NCB Periprosthetic Trochanter Plate, Add-On set, bottom tray
00-5900-099-00	Generic Stackable Lid Assembly

### Optional Graphic Cases

REF	Description
02.00024.908	NCB Periprosthetic Plate System, Femur Provisionals, base
02.00024.909	NCB Periprosthetic Plate System, Add-On to NCB-DF, base and trays
02.00024.910	NCB Periprosthetic Plate System, Add-On to NCB-DF, base
02.00024.911	NCB Periprosthetic Plate System, Add-On to NCB-DF, screw caddy
02.00024.912	NCB Periprosthetic Plate System, Add-On to NCB-DF, tray
00-5900-099-00	Generic Stackable Lid Assembly

## Planning Aid

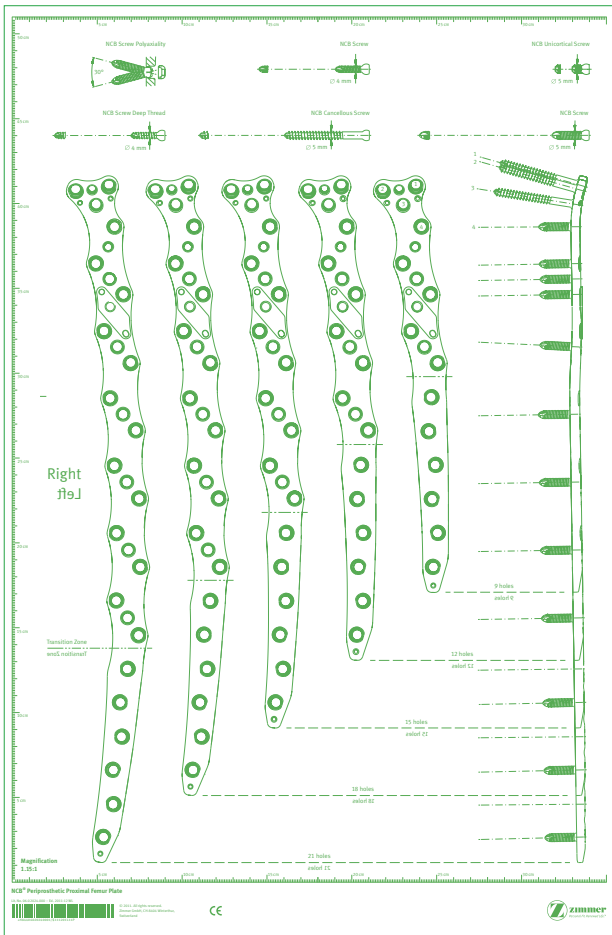

NCB Periprosthetic Proximal Femur Plate X-ray Template

Lit.No. 06.02024.000

Lit.No. 97-2370-050-02 (US only)

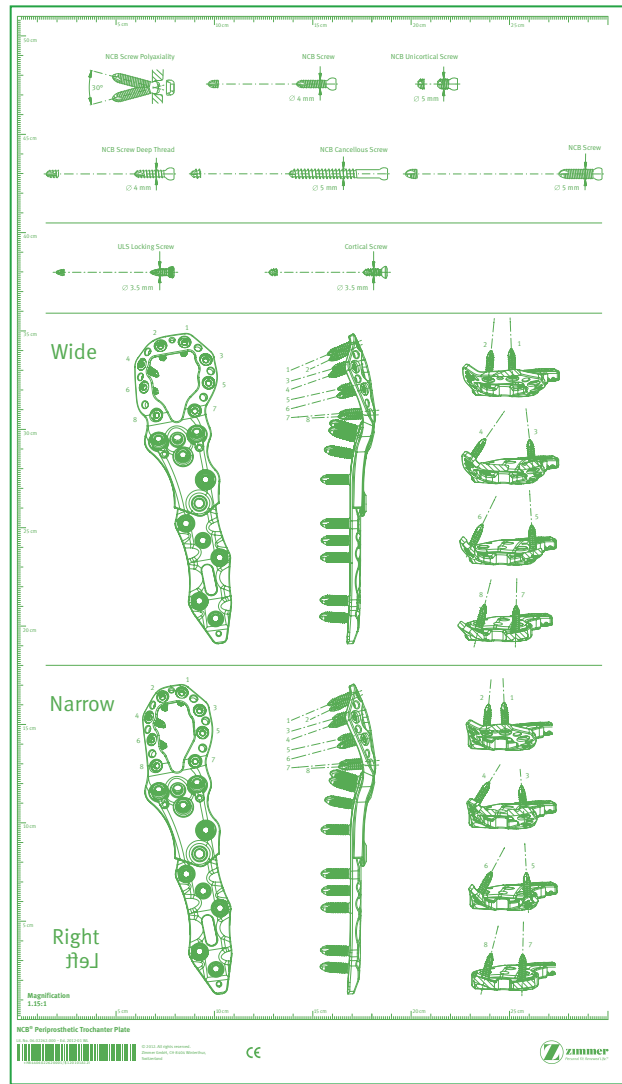

NCB Periprosthetic Trochanter Plate X-ray Template

Lit.No. 06.02262.000

Lit.No. 97-2370-008-00 (US only)

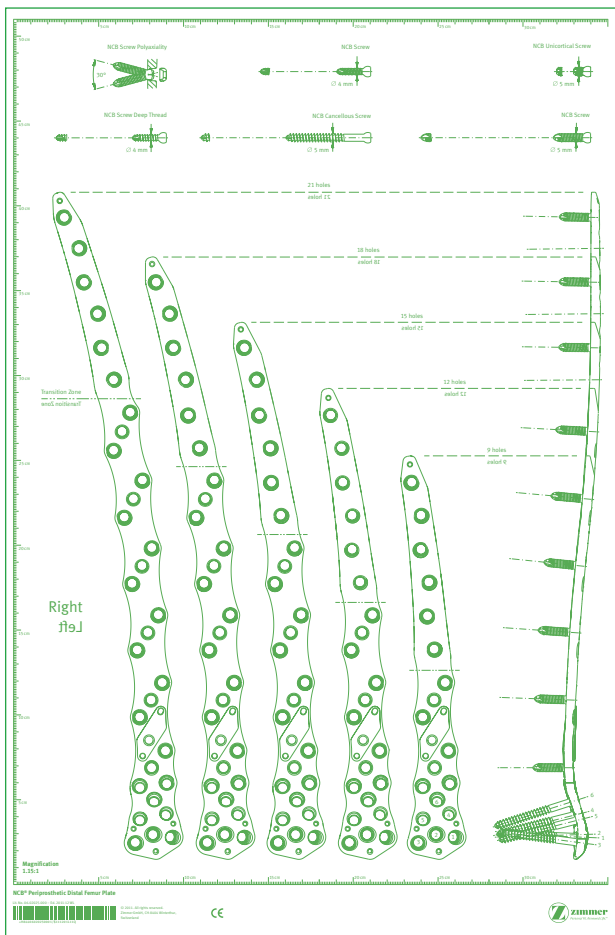

NCB Periprosthetic Distal Femur Plate X-ray Template

Lit.No. 06.02025.000

Lit.No. 97-2370-050-01 (US only)

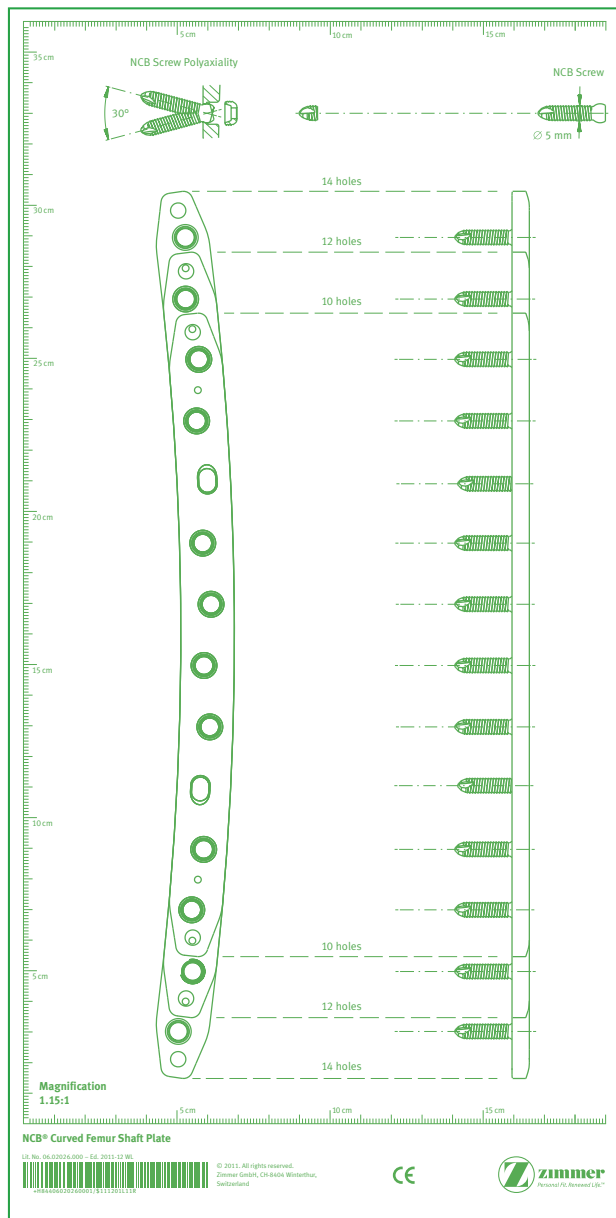

NCB Curved Femur Shaft Plate X-ray Template

Lit.No. 06.02026.000

Lit.No. 97-2370-050-03 (US only)

**Disclaimer**

This documentation is intended exclusively for physicians and is not intended for laypersons. Information on the products and procedures contained in this document is of a general nature and does not represent and does not constitute medical advice or recommendations. Because this information does not purport to constitute any diagnostic or therapeutic statement with regard to any individual medical case, each patient must be examined and advised individually, and this document does not replace the need for such examination and/or advice in whole or in part. Please refer to the package inserts for important product information, including, but not limited to, indications, contraindications, warnings, precautions, and adverse effects.

Contact your Zimmer representative or visit us at [www.zimmer.com](http://www.zimmer.com)



Lit. No. 06.02013.012 – Ed. 2015-05 ZHUB



\*H84406020130121/\$150428D15\*