

NCB® Proximal Tibia System

Surgical Technique

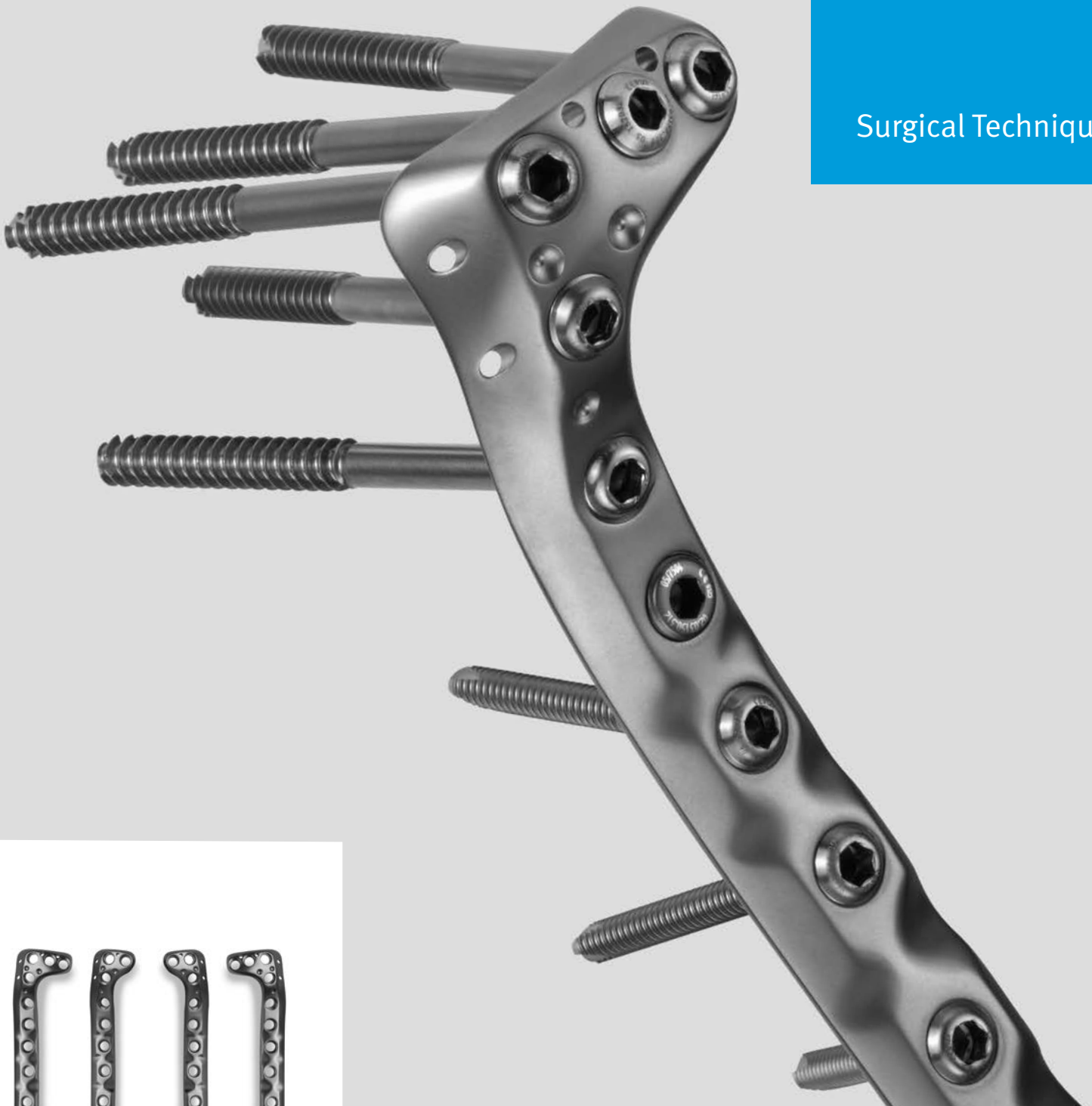

Surgical Technique

NCB Locking Plate System for Proximal Tibia

Table of Contents

Introduction	4
Plate Design	5
Screw Selection	5
Cable Fixation Options	6
MIS Radiolucent Targeting Device	7
System Features	7
Indications/Contraindications	8
Fracture Classification	8
Sample Cases	9
Preoperative Planning and Patient Positioning	11
Open Technique	12
Incision	12
Fracture Reduction	12
Optional: Bone Spacers	12
Insertion of NCB PT Plate	13
Insertion of NCB Screws	13
MIS Technique*	18
Plate Hole Numbering System	18
Incision and Fracture Reduction	18
Targeting Device Assembly	19
Insertion and Preliminary Fixation of NCB PT Plate	19
Insertion of NCB Screws in the Proximal Area	21
Insertion of NCB Screws in the Shaft	22
Implant Removal	24
Ordering Information	25
Implants	25
Graphic Case	28
Standard Instruments	29
MIS Instruments	30
Cannulated Option (Screws and Instruments)	32
Planning Aid	33

*MIS *Minimally Invasive Solutions™* Technique by Zimmer

Introduction

The **NCB PT (Non-Contact Bridging for the Proximal Tibia)** is an optimal plate solution for the treatment of complex fractures of the proximal tibia.

The system allows for polyaxial screw placement (30°) with subsequent screw locking. Before locking, the screws can act as lag screws and be used for fracture reduction; a benefit which is not offered with standard locking systems.

In the locked mode, **NCB PT Plate** late acts as an internal fixator without contact between the plate and the bone surface reducing the risk of periosteal blood supply impairment.

The surgical technique is based on the well-known standard plate osteosynthesis technique which gives to surgeon the feeling for bone quality during drilling and tightening of the screws. In the last step all screws can be locked and made angularly stable.

The instrumentation includes a fully radiolucent targeting device for a minimally invasive surgical technique (MIS).



Implants are available with 2 or 3 proximal holes, left and right. Plate length varies from 5 to 9 shaft holes for the 2-proximal hole plate and between 3 and 13 shaft holes for the 3-proximal hole plate.

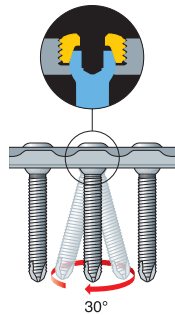

Polyaxial screw placement with subsequent locking option for optimal system stability. Fracture reduction with a lag screw possible.

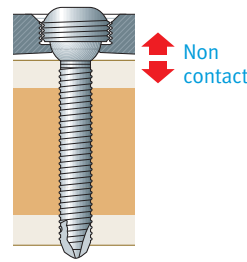

Non-Contact Bridging osteosynthesis reduces the risk of periosteal blood impairment.

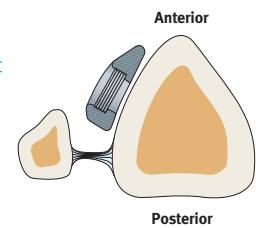

Anatomically contoured plate.



Locking cap \varnothing 8 mm



Blind screw insert



Spacer 1 to 3 mm

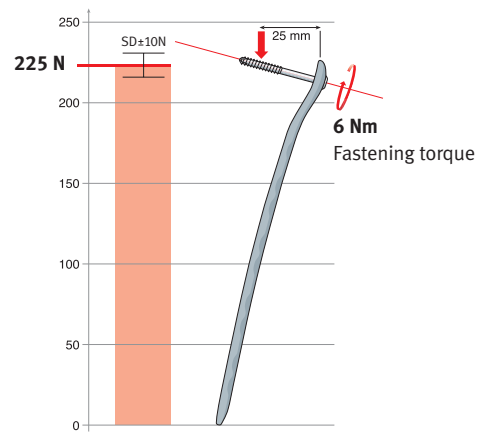

Angular stability of one **NCB Locked Screw**

Materials: **NCB Plates and Screws** are made of Ti6Al4V, ISO 5832-3, ASTM F136

Plate Design

Two versions of the NCB PT Plate are available: 2-proximal and 3-proximal holes.

Due to the angular freedom of the screws the whole plateau area can be covered with both plates. The 2-proximal holes plate is recommended when soft tissue coverage is a greater concern.

The 3-proximal holes plate is recommended when there is a higher concern for supporting the tibial plateau (e.g. severe intra-articular comminution).

Plate head has 6° posterior tilt to match the lateral tibial contour.

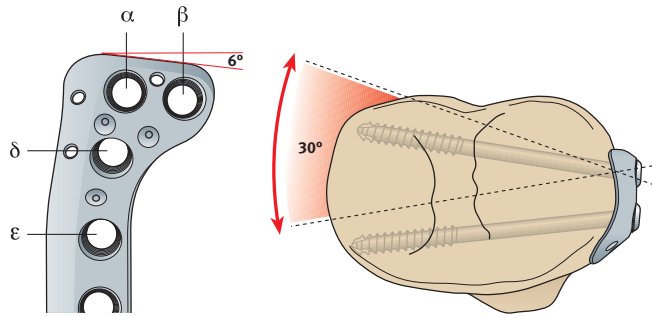

2-proximal holes plate

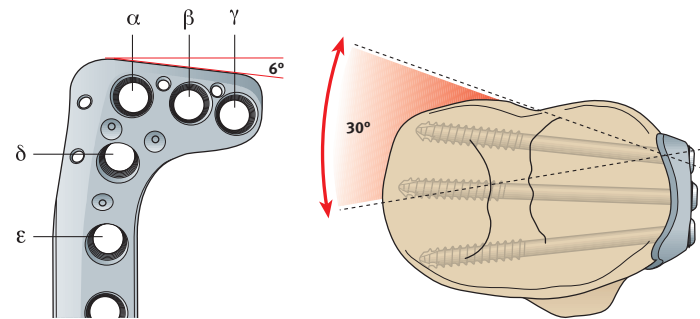

3-proximal holes plate

Screw Selection

- Spherical screw head with standard 3.5 mm hexagonal drive
- Self-tapping screw tip (solid screws)
- Self-drilling and self-tapping screw tip (cannulated screws)
- Double-lead thread for fast screw insertion in cortical bone

Standard Screws

(included in the screw set)



Cancellous screw Ø 5.0 mm self tapping, L 50–90 mm; 5 mm L 95 & 100mm (not in set)

Cannulated Screws

(option)



Cannulation for 1.6 mm K-wire

Cancellous screw Ø 4.5 mm self drill L 50–100 mm; 5 mm

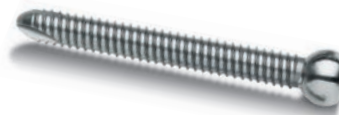

Cortical screw Ø 4.0 mm self tapping, L 14–50 mm; 2 mm L 50–90 mm; 5 mm L 95 & 100mm (not in set)

Zimmer® MotionLoc® Screws

(option)



Cortical screw self tapping Ø 4 mm; L 24–46; 2 mm

Cable Fixation Options

The following products from the Zimmer® Cable-Ready® Cable Grip System are compatible with all plates in the NCB Proximal Tibia System except for the 3 hole length tibial NCB plate with 3 proximal holes (REF 02.02261.203 and 02.02261.303)**. See data sheet REF 97-2232-015-00 for more specific instructions.



NCB Locking Plate Cable Button, 2.5mm, Hex Drive

- Sterile
- Material: Ti6Al4V

REF 47-2232-060-00 Color: Gold*
REF 47-2232-060-01 Color: Blue

Application

This Cable Button is threaded directly into the NCB Plate hole to provide a positioning point for the Cable.

Instructions

To insert, use the 2.5mm hex screwdriver to thread the cable button into the plate hole. Do not fully tighten to allow the slots in the button to align with the cable.

To remove, use the 2.5mm hex screwdriver to unthread the cable button from the plate hole.



Hex Button, 3.5mm

- Sterile
- Material: C.P. Titanium

REF 00-2232-002-35

Application

This Hex Button fits into the standard hex in the screw head (3.5mm hex). Therefore, it can be inserted into the NCB Screw head, or into the NCB Locking Cap.



Cable Assembly Cerclage, 1.8mm

- Sterile
- Material: CoCr

REF 00-2232-002-28
REF 00-2232-004-18



Cable Fixation Options



Cable Fixation with
Cable Button



Cable Fixation with
Hex Button

* Not available in Europe, Middle East and Africa.

** The 3 hole length tibial NCB plate with 3 proximal holes (REF 02.02261.203 and 02.02261.303) is a product of BAAT Medical BV and is distributed by Zimmer only in Europe, Middle East, and Africa.

MIS Radiolucent Targeting Device

MIS* operation technique with a fully radiolucent targeting device.



Divergent screw alignment achieved using the targeting device

In the metaphyseal region the targeting device ensures divergent screw alignment for increased pull-out resistance.

System Features

- Polyaxial screw placement with subsequent locking option;
- Anatomically contoured plate with asymmetrical plate cross section to facilitate anterolateral soft tissue coverage;
- Plate head has 6° posterior tilt to match the lateral tibial contour;
- Placement of divergent screws to increase pull-out resistance;
- MIS Approach with a fully radiolucent targeting device;
- NCB Cancellous Screws can be used as lag screws to improve fracture reduction;
- Use of conventional plating technique;
- Feeling of bone quality during inserting and tightening of screws;
- The 2-proximal holes tibial plate is available in 3 lengths, from 5 holes (132 mm) to 9 holes (212 mm);
- The 3-proximal holes tibial plate is available in 5 lengths, from 3 holes (92 mm) to 13 holes (292 mm).

Note: Do not use the MIS device with the 3 hole length tibial NCB plate with 3 proximal holes (REF 02.02261.203 and 02.02261.303)**.



NCB PT Plate System

* MIS Minimally Invasive Solutions Technique by Zimmer

** The 3 hole length tibial NCB plate with 3 proximal holes (REF 02.02261.203 and 02.02261.303) is a product of BAAT Medical BV and is distributed by Zimmer only in Europe, Middle East, and Africa.

Indications

The *NCB* Polyaxial Locking Plate System is indicated for temporary internal fixation and stabilization of fractures and osteotomies of long bones.

Note: The *NCB* Proximal Tibia plate from the *NCB* Polyaxial Locking Plate System is specifically designed for the proximal tibia.

Contraindications

- All concomitant diseases that may impair the fixation of the implant and/or the success of the intervention.
- Lack of bone substance or poor bone quality which makes stable seating of the implant impossible.
- Acute or chronic, local or systemic infections.
- Allergy to the implanted material.
- Severe muscular, neural or vascular diseases that endanger the extremities involved.

Fracture Classification

Comprehensive classifications for proximal tibial fractures are the OTA and the Schatzker classifications.

Stabilization with locking plates is recommended for most of the 41-A and C type of fracture according to the OTA classification for long bone.

This includes comminuted fractures, intra-articular and extra-articular condylar fractures.

Schatzker Classification

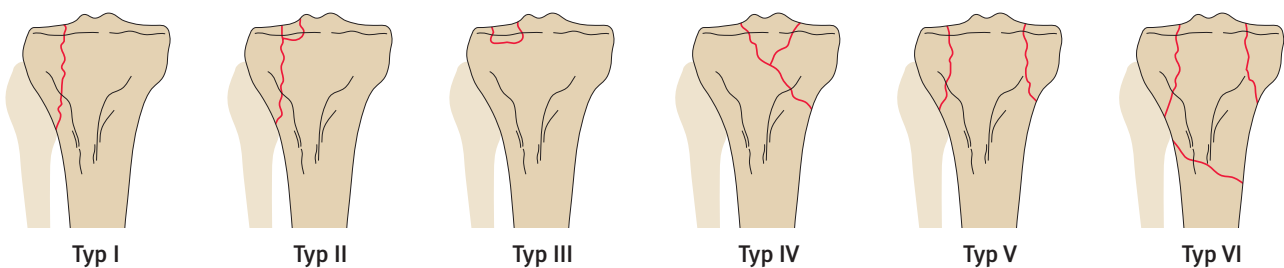

Note: Be sure to check for proper Regulatory approvals in your country prior to using any products found in this surgical technique. Some devices may not be currently licensed with Health Canada. Some device compatibilities may not be approved for use by Health Canada.

OTA Classification

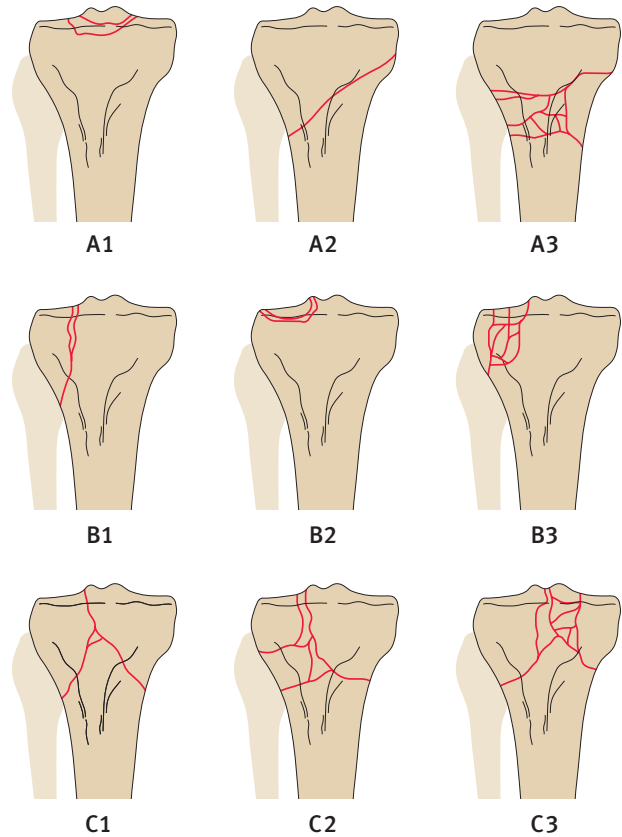

Sample Cases

Case 1: 41-C1 fracture
(OTA classification)



Preoperative



Postoperative



Preoperative



Postoperative

Case 2: 41-A2 fracture
(OTA classification,
MIS surgical procedure)



Preoperative



Postoperative

Preoperative Planning and Patient Positioning

Select the appropriate length and type of the *NCB* PT Plate using X rays and the X ray template (REF 06.01365.000).

Based on the fracture type and the specific patient condition determine the surgical approach (i.e., open technique or MIS) to be performed.

Place the patient in a supine position. Lower the contralateral leg slightly to make sure that lateral and AP X ray views can be obtained clearly.

Support the knee while allowing the leg to move freely.

Note: Do not use the x-ray template with the 3 hole length tibial *NCB* plate with 3 proximal holes (REF 02.02261.203 and 02.02261.303)**.

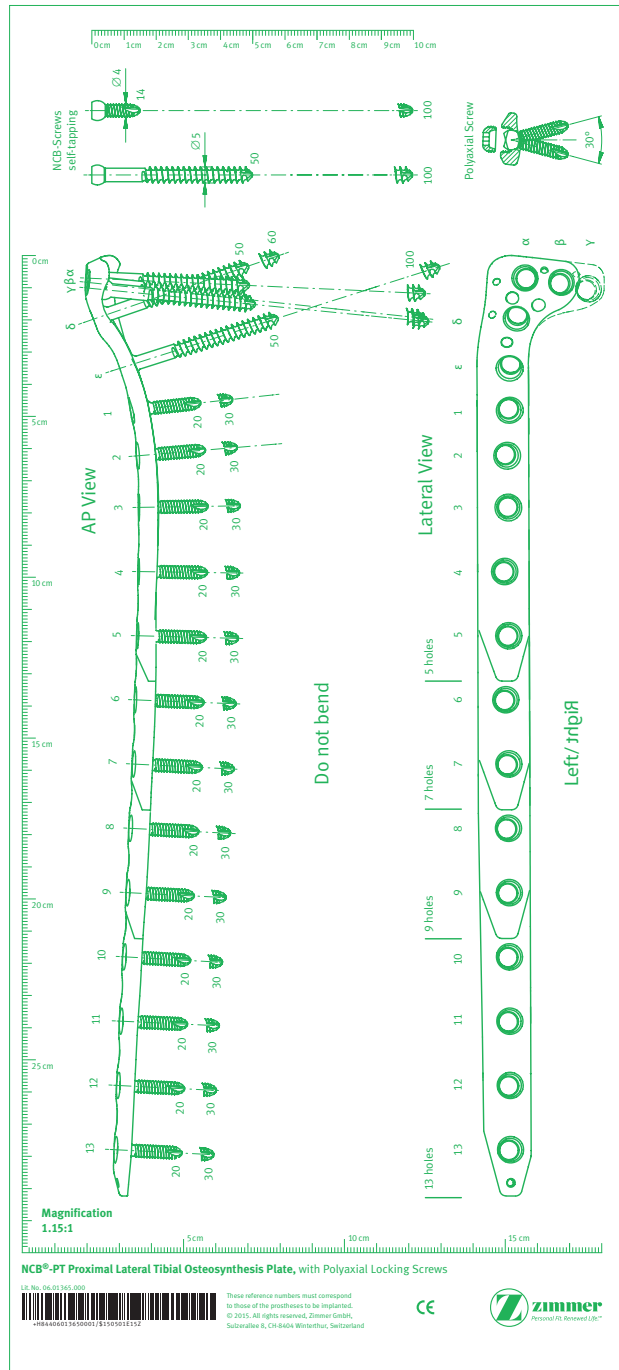

Choose plate type and length using the X ray template

** The 3 hole length tibial *NCB* plate with 3 proximal holes (REF 02.02261.203 and 02.02261.303) is a product of BAAT Medical BV and is distributed by Zimmer only in Europe, Middle East, and Africa.

Open Technique

Incision

A lateral incision is recommended for extra-articular and laterally based type 41-B fractures, according to the OTA classification.

For type 41-C fractures according to the OTA classification with a complete articular fracture, a straight antero-lateral incision or short medial and lateral incisions are recommended.

To facilitate fracture healing do not strip the periosteum.

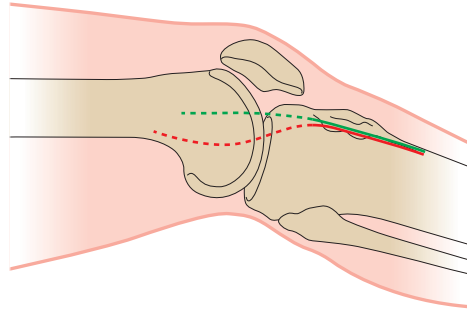

Incision

Fracture Reduction

Restore the articular surface (if needed) and reduce the fracture prior to inserting the plate. Bone fragments can be secured with 2.0 mm K-wires (REF 290.20.280). Make sure that K-wires do not interfere with the future location of the plate and screws.

Note: Check fragment position with an image intensifier.

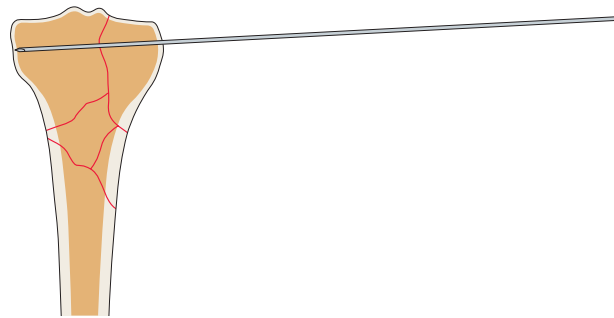

Temporary stabilization of the fracture

Optional: Bone Spacers

Two bone spacers can be used in the diaphysis to avoid contact of the plate with the bone surface reducing the risk of periosteal blood supply impairment.

The spacers are available in sizes of 1 mm, 2 mm and 3 mm (REF 02.0x150.311 to 313).

Note: Insert adequate bone spacers into the plate before plate insertion using a 3.5mm hex screwdriver. Spacers are single use only and they can be removed after locking the screws.

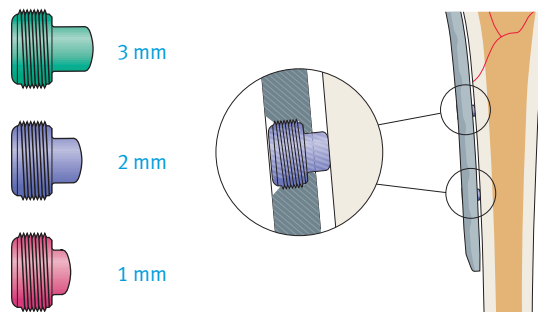

Use of bone spacers for non-contact bridging

Insertion of NCB PT Plate

Insert the plate (REF 02.02261.xxx) between the anterior tibialis muscle and the periosteum.

The plate should be placed as close as possible to the cartilage.

Temporarily fix the plate proximally and distally with 2.0 mm K-wires through the small holes in the plate.



Check the plate position and the fracture alignment with an image intensifier in both planes. Make sure the leg axis has been restored.

Note: The plate is anatomically shaped. Do not bend or contour the plate to avoid damage of the locking mechanism.

Insertion of NCB Screws

A maximum of thirty degrees of screw angulation is allowed in all plate holes. Use the *NCB Drill Guide* to avoid excessive screw angulation with consequent failure of the locking mechanism.

Screw Type

Cancellous	Cortical	Cancellous cannulated
REF 02.0x152.0xx	REF 02.0x155.0xx	REF 02.0x158.0xx
5 mm	4 mm	4.5 mm
L 50–100 mm	L 14–100 mm	L 50–100 mm
		
Drill		
REF 103.25.180	REF 02.00024.118	REF 02.00024.233
2.5 mm	3.3 mm	3.3 mm
Guide Wire		REF 02.01362.116
		1.6 mm, L 190 mm

Note: The \varnothing 4 mm *NCB MotionLoc* Screws are also compatible with all plates in the Proximal Tibia Plate System except for the 3 hole length tibial *NCB* plates with 3 proximal holes (REF 02.02261.203 and 02.02261.303)**. See *Zimmer MotionLoc* surgical technique (REF 97-3161-002-00 or 97-3161-004-00)* for more specific instructions.

* 97-3161-002-00 is for countries where *NCB MotionLoc* screws are approved to be used with only *NCB* plates and 97-3161-004-00 is for countries where *NCB MotionLoc* screws are approved to be used with both *NCB* as well as *NCB* Periprosthetic plates. See *NCB MotionLoc* package insert for approved plate/*MotionLoc* screw combinations.

** The 3 hole length tibial *NCB* plate with 3 proximal holes (REF 02.02261.203 and 02.02261.303) is a product of BAAT Medical BV and is distributed by Zimmer only in Europe, Middle East, and Africa

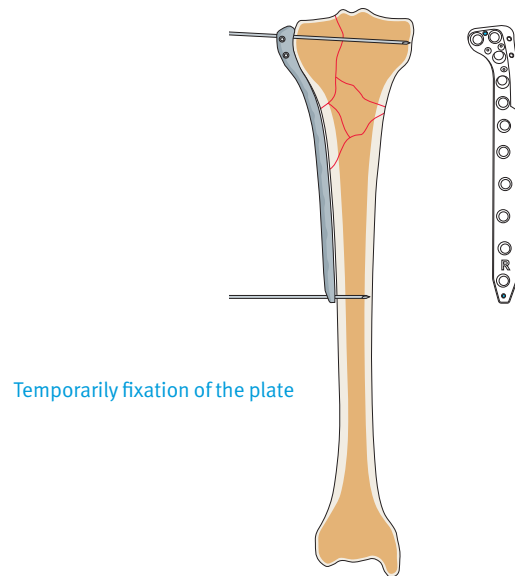

Temporarily fixation of the plate

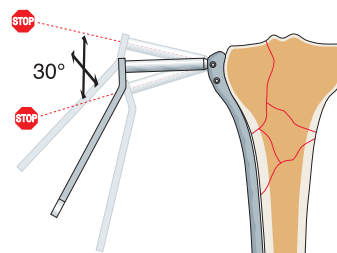

Use the *NCB Drill Guide* to avoid an inclination > 30°

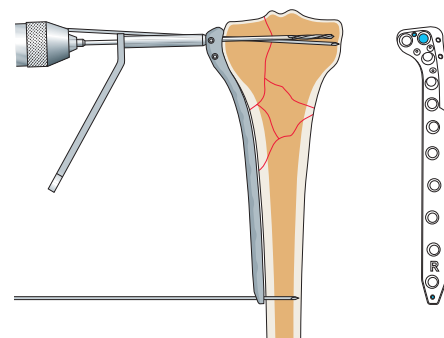

Drilling

Cancellous Screws

For the 5.0 mm cancellous screws (REF 02.0x152.xxx) use the *NCB Drill Guide* 2.5 mm (REF 02.00024.010). To ensure correct use of the drill guide, press the drill guide into the plate hole in a perpendicular position and then tilt it into the preferred position. The drill guide needs to be in constant contact with the bottom ring of the hole.

Use the 2.5 mm drill bit (REF 103.25.180) for the 5.0 mm cancellous screws.

Use the *NCB* Depth Gauge (REF 02.00024.005) to determine the appropriate screw length.

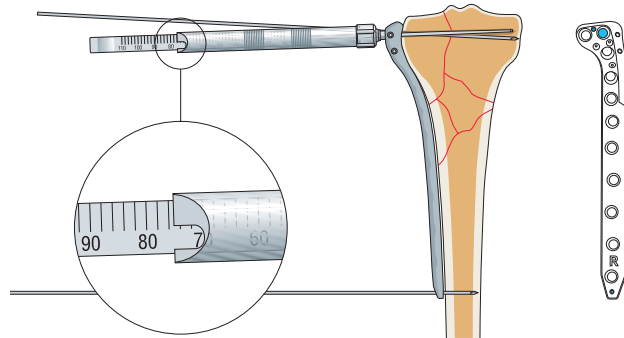

Determine screw length with the *NCB* Depth Gauge

Insert *NCB* Cancellous Screws using the *NCB* PT Hexagonal Screwdriver, (REF 02.00024.124) and apply compression if needed. Cancellous screws are partially threaded and can be used as lag screws.

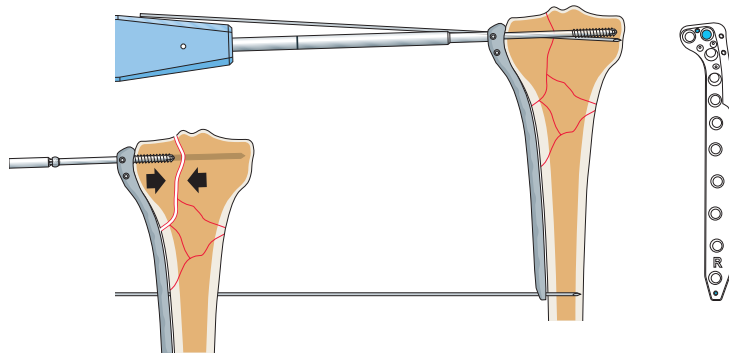

Use the *NCB* PT Hexagonal Screwdriver to hand tighten the screw and apply compression (if needed)

Depending on fracture type, in the epiphyseal and metaphyseal areas, screws should be tightened to reduce the fracture and obtain close contact between the plate and the bone in order to buttress the fracture.

Note: Tighten the bone screws by hand only.

Repeat this procedure to insert all the necessary *NCB* Cancellous Screws.

It is recommended that the most proximal cancellous screws be placed parallel to the tibia plateau.

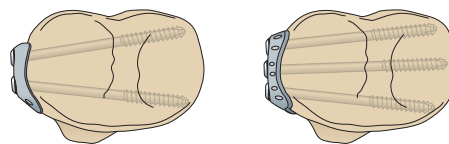

Possible setting of the most proximal cancellous screws

Check the fracture reduction, plate position and the leg axis with an image intensifier.

To secure the angular stability insert the *NCB* Locking Caps (REF 02.03150.300) on all the cancellous screws used. Tighten the locking caps with the *NCB* Torque Screwdriver, 6 Nm (REF 02.00024.021) until a clicking sound is heard.

Note: Always use the torque screwdriver to tighten the locking caps and make sure the screwdriver is not tilted during its usage. Failure to do so could damage the hex drive and might complicate extraction of the implant.

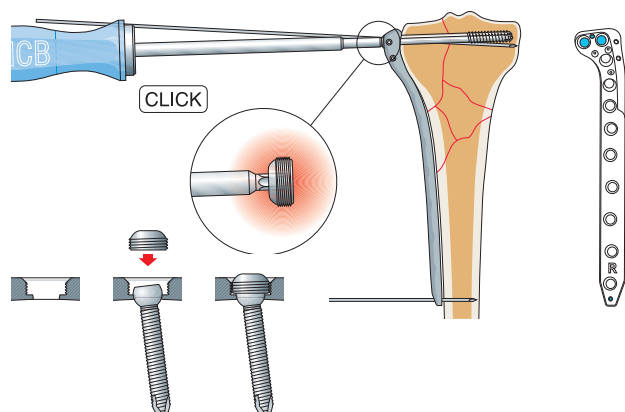

Insert the locking caps using the *NCB* Torque Screwdriver to achieve 6 Nm

Remove the proximal K-wire.

Optional

Cannulated Cancellous Screws

NCB Cannulated Cancellous Screws are self-drilling and self-tapping. These screws can be precisely placed over the NCB Guide Wire, \varnothing 1.6 mm. A cannulated drill bit can be used to pre-drill hard cortical bone.

Insertion of the \varnothing 1.6 mm NCB Guide Wire

Use the NCB Drill Guide to avoid excessive angulation of the cannulated screws with consequent failure of the locking mechanism.

For the 4.5 mm cannulated cancellous screws (REF 02.0x158.0xx) insert the NCB PT Drill Guide \varnothing 3.3/1.6 mm (REF 02.00024.192) into the NCB Drill Guide \varnothing 3.3 mm (REF 02.00024.111).

Press the drill guide into the plate hole, tilt it in the preferred position and insert the NCB Guide Wire with threaded tip (REF 02.01362.116).

Note: use only the NCB Guide Wire (REF 02.01362.116) \varnothing 1.6 mm, L = 190 mm.

Failure to do so misleads the screw length measurement.

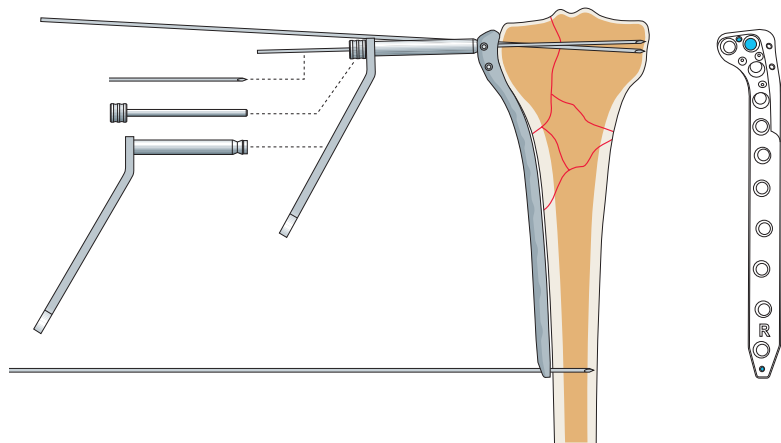

Use the NCB Drill Guides to avoid an inclination 30° when inserting the NCB 1.6 guide wire

Insertion of the Cannulated Cancellous Screws

Remove the *NCB Drill Guide* \varnothing 3.3 mm (REF 02.00024.111) and *NCB PT Drill Guide* \varnothing 3.3/1.6 mm (REF 02.00024.192) and determine the screw length from the measurement with the *NCB PH/PT Measuring Device* (REF 02.00024.219) along the *NCB Guide Wire*.

For hard cortical bone it is possible to use the \varnothing 3.3 mm *NCB PT Cannulated Drill Bit* (REF 02.00024.233).

Note: use the \varnothing 3.3 mm *NCB PT Cannulated Drill Bit* (REF 02.00024.233) only for the first lateral cortex, to make sure that the *NCB Guide Wire* does not fall out.

Use the cannulated hexagonal screwdriver (REF 02.00024.120) to insert the cannulated self-drilling screws over the 1.6 mm *NCB Guide Wire*.

To achieve the final angular stability remove the *NCB Guide Wire* and tighten the locking cap with the torque screwdriver 6 Nm (REF 02.00024.021) until the clicking sound is heard.

Note: it is important to remove the *NCB Guide Wire* (REF 02.01362.116) prior to inserting the locking cap (REF 02.0x150.300) because the axial directions for the cannulated screws and locking cap may be different.

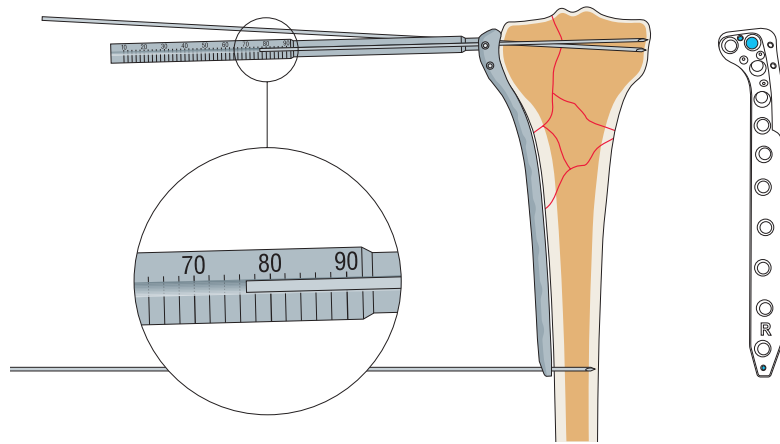

Measure the screw length with the *NCB PH/PT Measuring Device*

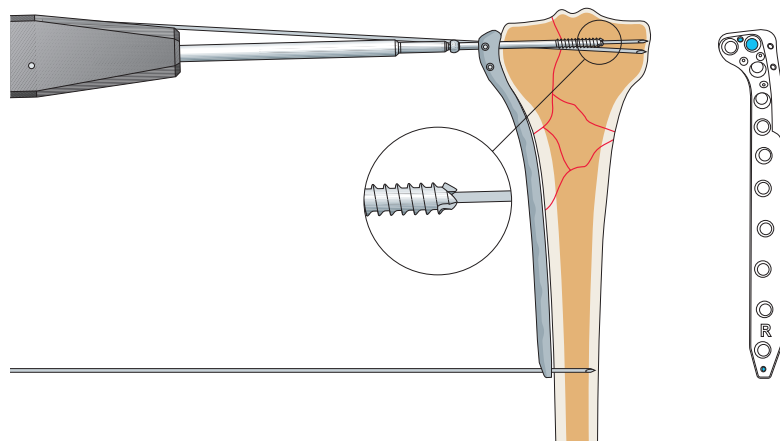

Insert the cannulated screw with the hexagonal cannulated screw driver

Cortical Screws

Bicortical insertion is recommended.

For the 4.0 mm cortical screws (REF 02.0x155.0xx) use the *NCB Drill Guide 3.3 mm* (REF 02.00024.111) with the 3.3 mm drill bit (REF 02.00024.118).

In case of hard cortical bone tap the cortex with the *NCB Tap* (REF 02.00024.040). Remove the *NCB Drill Guide 3.3 mm* when using the *NCB Tap*.

Measure the screw length and insert *NCB Cortical Screw* using the *NCB Hexagonal Screwdriver* (REF 02.00024.124).

Note: Tighten the bone screws by hand only.

Repeat this procedure to insert all the needed *NCB Cortical Screws*.

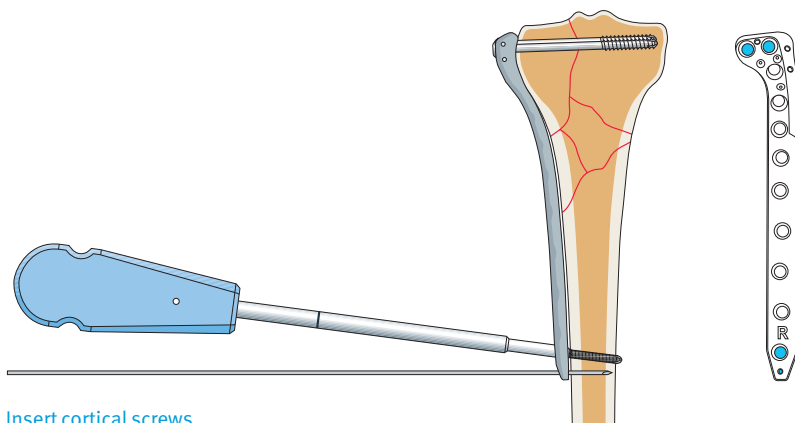
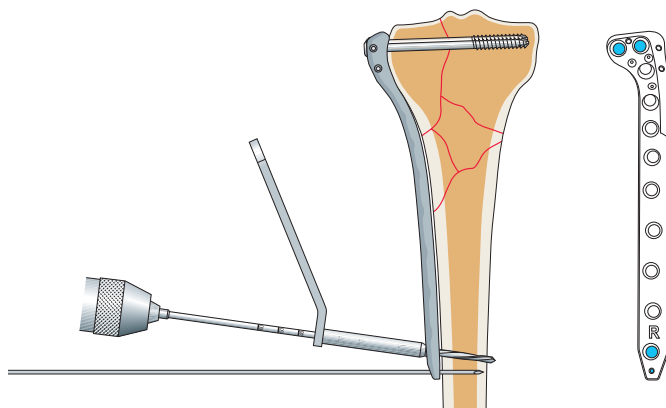

Insert cortical screws

Insert the *NCB Locking Caps* (REF 02.x150.300) to secure the angular stability as described for the cancellous screws.

Remove the distal K-wire after completing screw insertions.

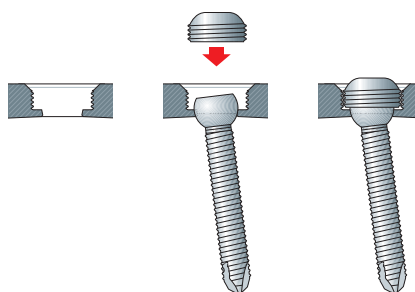

Insert the locking caps using the *NCB Torque Screwdriver* to achieve 6 Nm

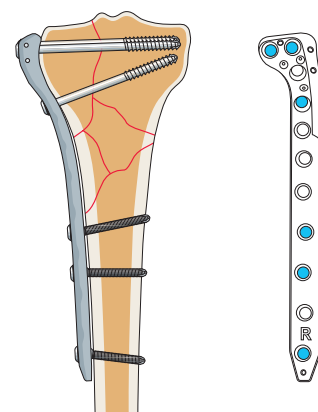

Possible final screw setting

MIS Technique

MIS is recommended for simple and/or extra-articular fractures. An open approach is recommended in the proximal area to restore the articular surface.

Plate Hole Numbering System

To target the correct plate holes there is a numbering system on the targeting devices (REF 02.00024.08x)

Screw holes in the proximal and metaphyseal areas are indicated with Greek letters (α , β , γ , δ and ϵ).

Screw holes in the shaft area are indicated with Roman numbers (1 to 13 according to plate length).

Note: Do not use the MIS device with the 3 hole length tibial *NCB* plate with 3 proximal holes (REF 02.02261.203 and 02.02261.303)**.

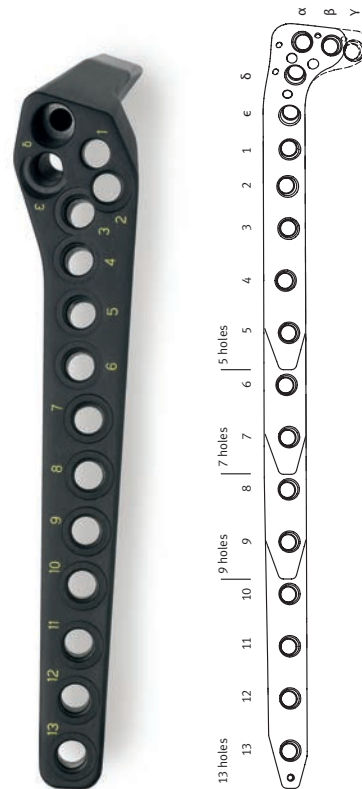

NCB Plate screw hole numbering system

Incision and Fracture Reduction

A lateral incision should start proximal to Gerdy's tubercle and should be extended for about 50 mm distally.

Note: Incision length will vary according to the type of fracture.

Reduce the fracture as described in the open technique. Take care that K-wires used to temporarily stabilize the fracture do not interfere with the future plate location.

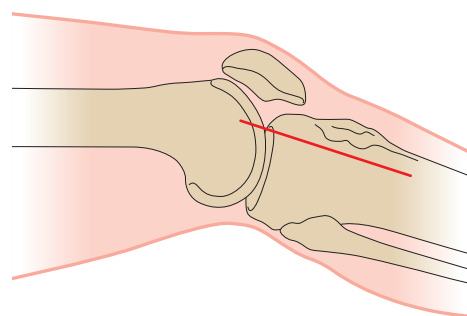

Incision

** The 3 hole length tibial *NCB* plate with 3 proximal holes (REF 02.02261.203 and 02.02261.303) is a product of BAAT Medical BV and is distributed by Zimmer only in Europe, Middle East, and Africa.

Targeting Device Assembly

Use the *NCB* PT right Targeting Device (REF 02.00024.080) for *NCB* PT Right Plates (REF 02.02261.xxx) and the *NCB* PT Left Targeting Device (REF 02.00024.081) for *NCB* PT Left Plates (REF 02.02261.xxx).

Center the targeting device in the specific indentations on the plate.

Insert and screw in the *NCB* PT Connection Bolt (REF 02.00024.083) in the “δ” hole of the targeting device.

Note: To guarantee accurate assembly of the plate/targeting device, insert the *NCB* PT stabilization bolt (REF 02.00024.084) into the targeting device hole corresponding to the last plate hole. Screw the *NCB* Stabilization Bolt into the plate and insert the safety lock pin (REF 02.00024.076) from the anterior side.

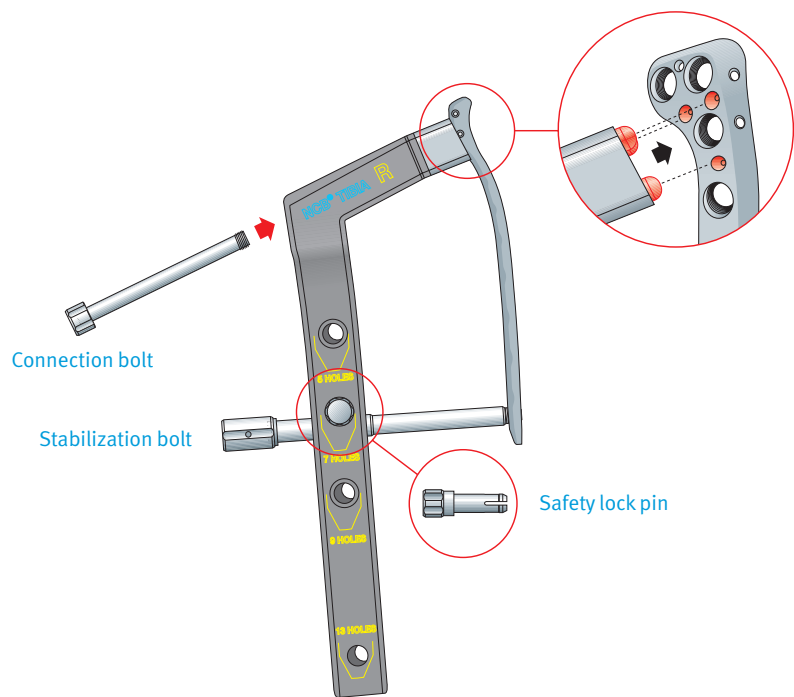

Assembly of the targeting device prior insertion

Once the assembly of the plate/targeting device has been accomplished, tighten the *NCB* Connection Bolt (REF 02.00024.083) with the screwdriver.

Remove the safety lock pin and the *NCB* PT Stabilization Bolt in order to insert the plate.

Insertion and Preliminary Fixation of *NCB* PT Plate

Under the image intensifier insert the plate between the anterior tibialis muscle and the periosteum: keep the distal end of the plate in continuous contact with the bone surface during insertion.

The plate should be placed as close as possible to the joint line.

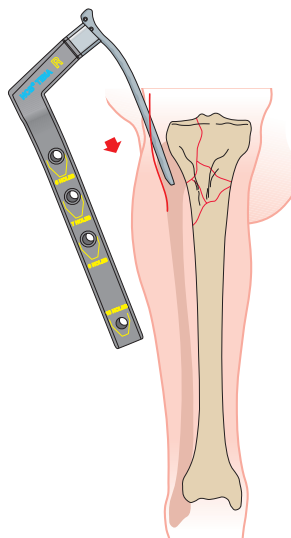

Slide the plate between the anterior tibialis muscle and the periosteum

Insert a 2.0 mm K-wire through one of the small proximal holes for temporary fixation of the plate.

Make a stab incision at the most distal plate hole.

Insert the *NCB* PT Stabilization Bolt (REF 02.00024.084), the *NCB* PT K-Wire Guide (REF 02.00024.092) and the *NCB* PT Trocar (REF 02.00024.093) into the corresponding hole on the targeting device.

Screw the *NCB* PT Stabilization Bolt (REF 02.00024.084) into the plate and insert the safety lock pin (REF 02.00024.076) as described previously.

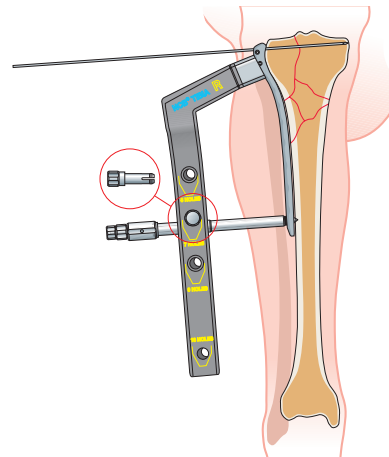
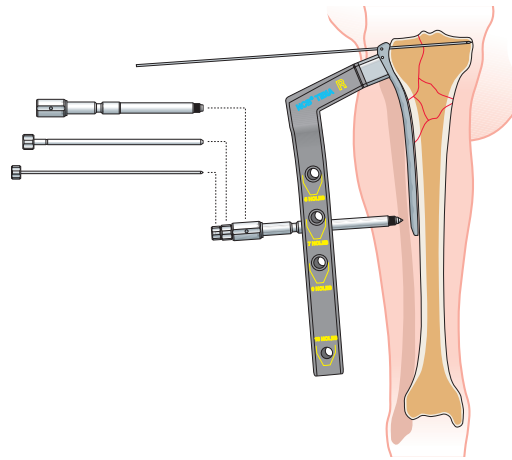

Close the plate targeting device configuration to guarantee correct correspondence between the targeting device and plate holes

Center the distal part of the plate on the bone using the image intensifier, remove the *NCB* PT Trocar and insert a 2.0 mm K-wire to fix the plate.

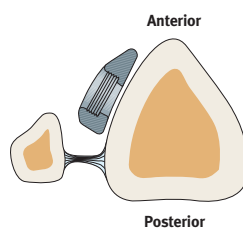

Center the distal part of the plate

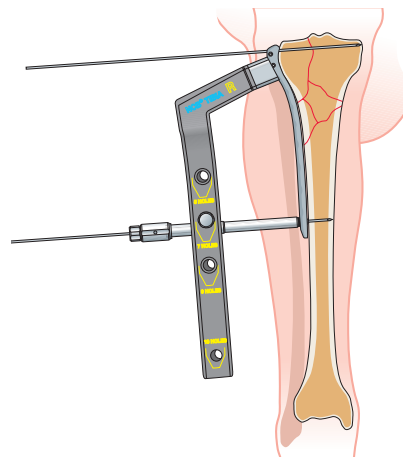

Temporary fixation of the plate

Insertion of NCB Screws in the Proximal Area

Use the same procedure as described in the open technique.

Repeat the procedure to insert the appropriate number of proximal screws.

Note: Check the fracture reduction and plate position under an image intensifier.

Lock the screws as described in the open technique.

Only the most proximal screws can be inserted with open technique when the targeting device is on.

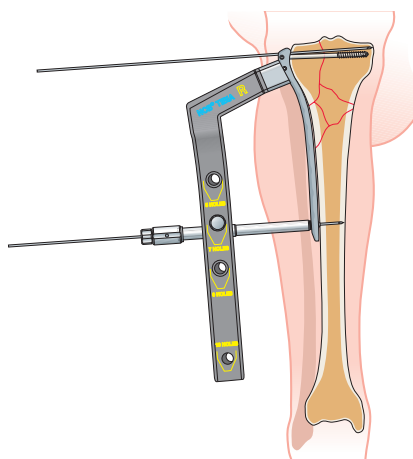
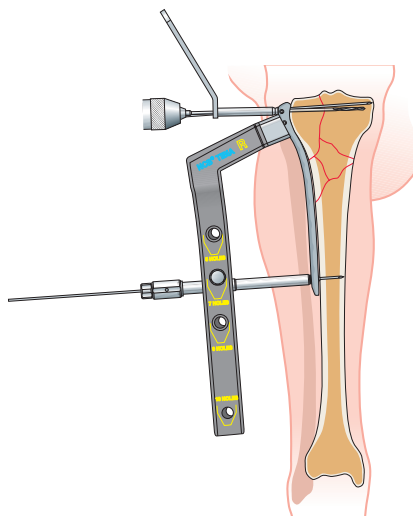

Use the drill guide and drill bit to insert cancellous screws as described in the open technique

The screw numbered “δ” needs to be inserted when the targeting device is removed at the end of surgery.

The screw numbered “δ” can be inserted using the corresponding hole on the targeting device following the procedure described below.

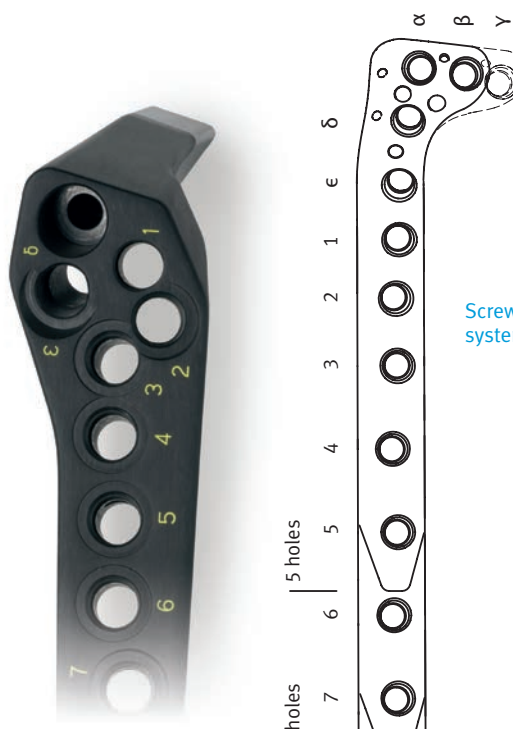

Screw hole numbering system

Insertion of NCB Screws in the Shaft

Make a stab incision to access the plate hole and insert the tissue protection sleeve assembly (REF 02.00024.090 to 093).

Screw the *NCB PT Drill Guide* (REF 02.00024.091) into the plate and then the *NCB PT soft tissue protection sleeve* (REF 02.00024.090) into the targeting device.

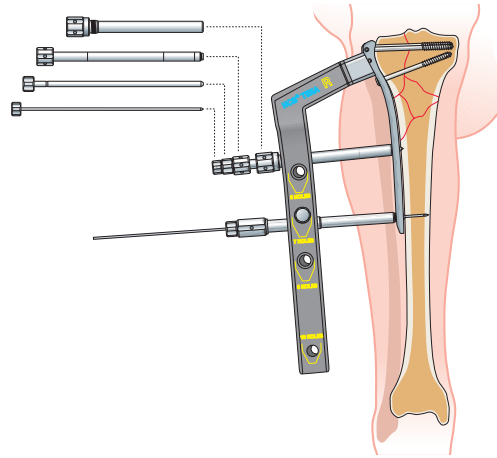

Insert the tissue protection sleeve

Remove the *NCB PT Trocar* and *NCB PT K-Wire Guide* and insert the *NCB PT Drill Bit 3.3 mm* (REF 02.00024.133) when the 4.0 mm cortical screw is used.

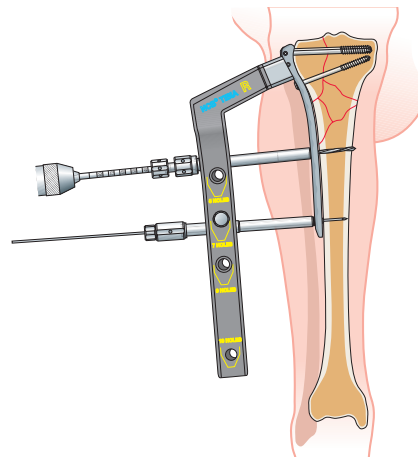

Drill the screw hole in the bone shaft

Use the scale on the drill bit shaft or the *NCB PT Depth Gauge* (REF 02.00024.007) to determine the appropriate screw length.

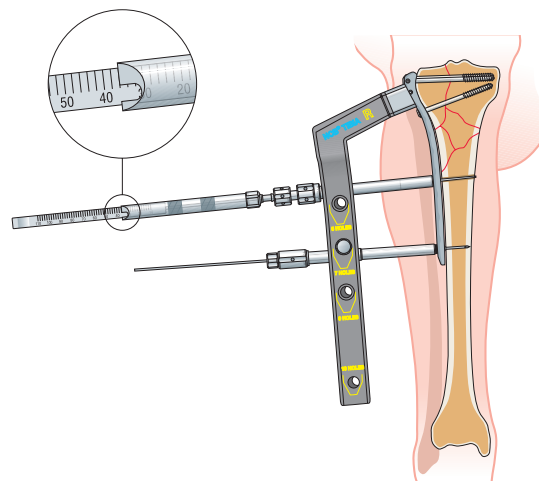

Alternative measuring of the screw length with the *NCB Depth Gauge*

Remove the *NCB PT Drill Guide* and insert the appropriate screw using the *NCB PT Hexagonal Screwdriver* (REF 02.00024.124).

Note: The screw is completely inserted when the marker on the screwdriver reaches the soft tissue protection sleeve.

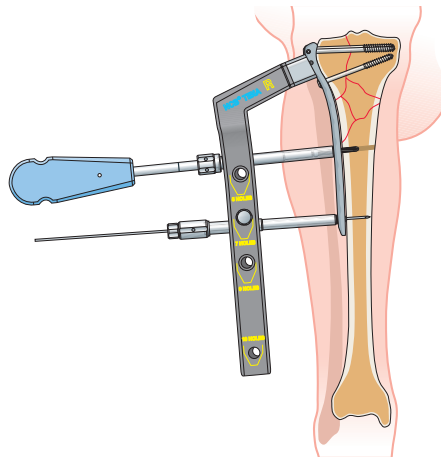

Insert the screw in the bone shaft

Insert and tighten the locking cap (REF 02.03150.300) with the *NCB Torque Screwdriver*, 6 Nm (REF 02.00024.021) until a clicking sound is heard.

Note: Always use the torque screwdriver to tighten the locking caps and make sure the screwdriver is not tilted during its usage. Failure to do so could damage the hex drive and might complicate extraction of the implant.

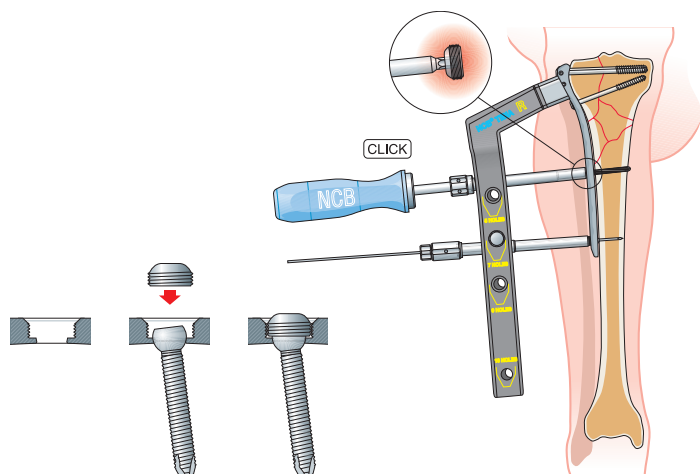

Insert the locking caps using the *NCB Torque Screwdriver* to achieve 6 Nm

Remove the *NCB PT Soft Tissue Protection* and insert the *NCB Screw Marker* (REF 02.00024.077) to indicate that the screw is placed and locked in the hole.

Repeat the described procedure to insert additional screws.

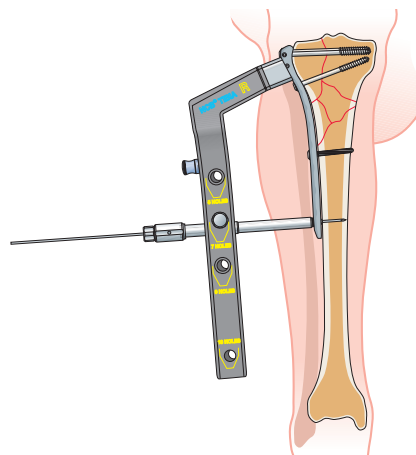

Use the screw marker to indicate that the screw is inserted and locked in the hole and proceed to insert additional screws

To place the most distal screw, exchange the *NCB* Stabilization Bolt with the *NCB* PT Drill Guide and protection sleeve and follow the procedure described above.

Unscrew the connecting bolt to remove the targeting device.

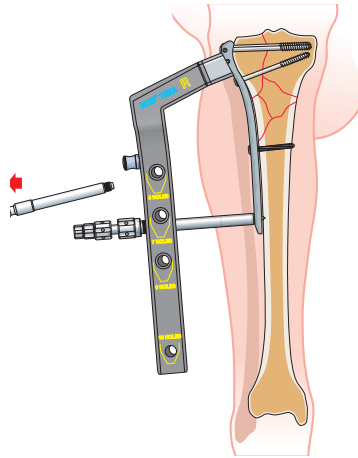

Remove the *NCB* Stabilization Bolt and insert the *NCB* Protection Sleeve to insert the most distal cortical screw

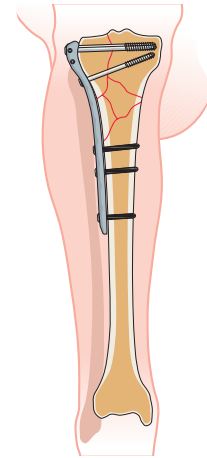

Possible final screw setting

Note: when using the long plate (i.e. 13 holes) the last three distal screws may interfere with the Superficial Peroneal nerve. Therefore, it is recommended a slightly longer stab incision to visualize and avoid damage to the Superficial Peroneal nerve.

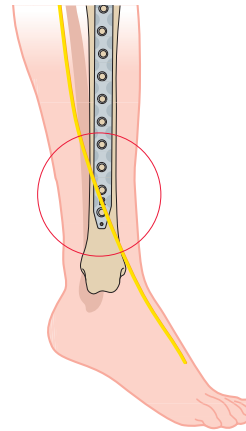

Take care to avoid damage of the Superficial Peroneal nerve when using long plates

Implant Removal

To remove the *NCB* PT Plate, first remove all the locking caps. Then loosen all the *NCB* Bone Screws without completely removing them (this prevents rotation of the bone plate when removing the last screw). Then, completely remove all the bone screws.

Note: make sure that the tip of the *NCB* PT Screwdriver (REF 02.00024.124) is correctly placed in the hex drive of the locking caps and/or *NCB* Screws. Failure to do so could damage the hex drive and complicate the extraction of the implant.

Removal Tips

- Re-assemble the *NCB* Targeting Device to remove the shaft screws if the MIS approach was used for implantation. The targeting device ensures that the axial direction used during implantation is considered.
- In case of difficulties in loosening the *NCB* Screws, tighten the screws slightly before loosening them.

Ordering Information – Implants

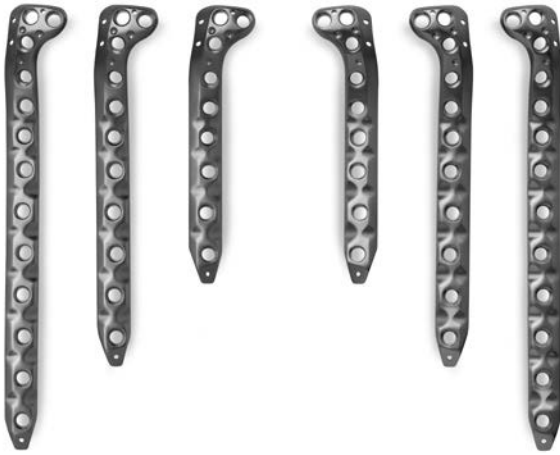

NCB® PT 2-proximal hole plate set

REF
ZS 02.00024.820

sterile-packed

STERILE R

Quantity*	Holes	mm	Side	REF
1	5	132	left	02.02261.105
1	7	172	left	02.02261.107
1	9	212	left	02.02261.109
1	5	132	right	02.02261.005
1	7	172	right	02.02261.007
1	9	212	right	02.02261.009



NCB® PT 3-proximal hole plate set

REF
ZS 02.00024.830

sterile-packed

STERILE R

Quantity*	Holes	mm	Side	REF
1	5	132	left	02.02261.305
1	7	172	left	02.02261.307
1	9	212	left	02.02261.309
1	5	132	right	02.02261.205
1	7	172	right	02.02261.207
1	9	212	right	02.02261.209

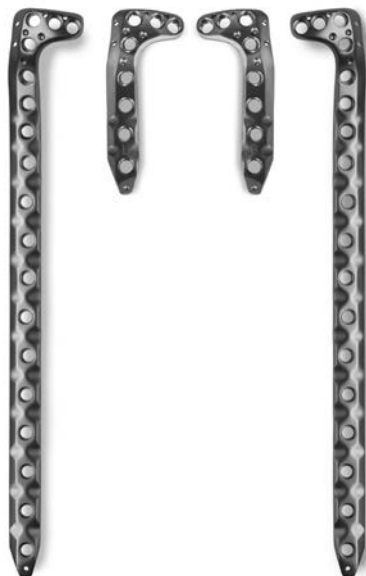

NCB® PT 3-proximal hole plate (optional)
3 and 13 hole lengths

sterile-packed

STERILE R

Quantity*	Holes	mm	Side	REF
–	3	92	left	02.02261.303**
–	3	92	right	02.02261.203**
–	13	292	left	02.02261.313
–	13	292	right	02.02261.213

Materials: NCB Plates and Screws are made of Ti6Al4V, ISO 5832-3, ASTM F136

* Indicates the quantity in the plate sets.

** The 3 hole length tibial NCB plate with 3 proximal holes (REF 02.02261.203 and 02.02261.303) is a product of BAAT Medical BV and is distributed by Zimmer only in Europe, Middle East, and Africa.



NCB® Locking Cap

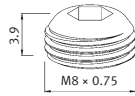

STERILE R

Quantity*	∅ mm	∅ mm	REF (Non Sterile)	REF (Sterile)
15	8	3.5	02.03150.300	02.02150.300



NCB® Blind Screw Insert

STERILE R

Quantity*	∅ mm	∅ mm	REF (Non Sterile)	REF (Sterile)
5	8	3.5	02.03150.310	02.02150.310



NCB® Spacer
(red, blue, green)

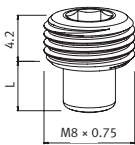

STERILE R

Quantity*	L mm	∅ mm	Color	REF (Non Sterile)	REF (Sterile)
2	1	3.5	red	02.03150.311	02.02150.311
2	2	3.5	blue	02.03150.312	02.02150.312
2	3	3.5	green	02.03150.313	02.02150.313



NCB® Screw, self-tapping

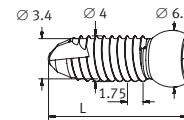

STERILE R

Quantity*	L mm	∅ mm	∅ mm	REF (Non Sterile)	REF (Sterile)
2	14	4.0	3.5	02.03155.014	02.02155.014
2	16	4.0	3.5	02.03155.016	02.02155.016
2	18	4.0	3.5	02.03155.018	02.02155.018
2	20	4.0	3.5	02.03155.020	02.02155.020
2	22	4.0	3.5	02.03155.022	02.02155.022
2	24	4.0	3.5	02.03155.024	02.02155.024
2	26	4.0	3.5	02.03155.026	02.02155.026
2	28	4.0	3.5	02.03155.028	02.02155.028
2	30	4.0	3.5	02.03155.030	02.02155.030
2	32	4.0	3.5	02.03155.032	02.02155.032
4	34	4.0	3.5	02.03155.034	02.02155.034
4	36	4.0	3.5	02.03155.036	02.02155.036
4	38	4.0	3.5	02.03155.038	02.02155.038
4	40	4.0	3.5	02.03155.040	02.02155.040
4	42	4.0	3.5	02.03155.042	02.02155.042
4	44	4.0	3.5	02.03155.044	02.02155.044
2	46	4.0	3.5	02.03155.046	02.02155.046
2	48	4.0	3.5	02.03155.048	02.02155.048
2	50	4.0	3.5	02.03155.050	02.02155.050
2	55	4.0	3.5	02.03155.055	02.02155.055
2	60	4.0	3.5	02.03155.060	02.02155.060
2	65	4.0	3.5	02.03155.065	02.02155.065
2	70	4.0	3.5	02.03155.070	02.02155.070
2	75	4.0	3.5	02.03155.075	02.02155.075
2	80	4.0	3.5	02.03155.080	02.02155.080
2	85	4.0	3.5	02.03155.085	02.02155.085
2	90	4.0	3.5	02.03155.090	02.02155.090
-	95	4.0	3.5	02.03155.095	02.02155.095
-	100	4.0	3.5	02.03155.100	02.02155.100

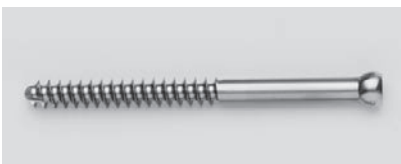

NCB® Cancellous Screw, thread length 32 mm

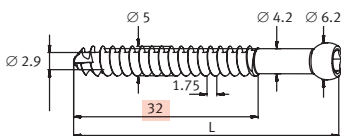

STERILE R

Quantity*	L mm	∅ mm	∅ mm	REF (Non Sterile)	REF (Sterile)
2	50	5.0	3.5	02.03152.050	02.02152.050
2	55	5.0	3.5	02.03152.055	02.02152.055
3	60	5.0	3.5	02.03152.060	02.02152.060
3	65	5.0	3.5	02.03152.065	02.02152.065
3	70	5.0	3.5	02.03152.070	02.02152.070
3	75	5.0	3.5	02.03152.075	02.02152.075
3	80	5.0	3.5	02.03152.080	02.02152.080
2	85	5.0	3.5	02.03152.085	02.02152.085
2	90	5.0	3.5	02.03152.090	02.02152.090
-	95	5.0	3.5	02.03152.095	02.02152.095
-	100	5.0	3.5	02.03152.100	02.02152.100

Materials: NCB Plates and Screws are made of Ti6Al4V, ISO 5832-3, ASTM F136

*Indicates the quantity of non sterile implants in the standard graphic case.

Compatible Zimmer Products with the NCB Proximal Tibia System** (optional)



NCB® MotionLoc® Screws, Ø 4.0mm Cortical, Self Tapping, Ti6Al4V

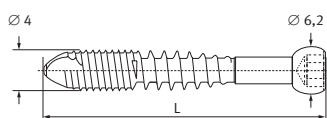

STERILE R

L mm	Ø mm	REF (Non Sterile)	REF (Sterile)
24	4.0	02.03162.024	02.02162.024
26	4.0	02.03162.026	02.02162.026
28	4.0	02.03162.028	02.02162.028
30	4.0	02.03162.030	02.02162.030
32	4.0	02.03162.032	02.02162.032
34	4.0	02.03162.034	02.02162.034
36	4.0	02.03162.036	02.02162.036
38	4.0	02.03162.038	02.02162.038
40	4.0	02.03162.040	02.02162.040
42	4.0	02.03162.042	02.02162.042
44	4.0	02.03162.044	02.02162.044
46	4.0	02.03162.046	02.02162.046

Cable Fixation Options

STERILE R

REF (Sterile)	Description
47-2232-060-00*	NCB Polyaxial Locking Plate Cable Button, Gold, 2.5mm Hex Drive, Material: Ti6Al4V
47-2232-060-01	NCB Polyaxial Locking Plate Cable Button, Blue, 2.5mm Hex Drive, Material: Ti6Al4V
00-2232-002-35	Hex Buttons, 3.5mm Hex, Material: C.P. Titanium
00-2232-004-28	Cable-Ready Cable Assembly Cerclage, Ø 1.8mm, L 914mm, Material: CoCr
00-2232-004-18	Cable-Ready Cable Assembly Cerclage, Ø 1.8mm, L 635mm, Material: CoCr

Materials: NCB Plates and Screws are made of Ti6Al4V, ISO 5832-3, ASTM F136

* Not available in Europe, Middle East and Africa.

** The MotionLoc screws and Cable Fixation options are compatible with all plates in the NCB Proximal Tibia System except for the 3 hole length tibial NCB plate with 3 proximal holes (REF 02.02261.203 and 02.02261.303)

*** The 3 hole length tibial NCB plate with 3 proximal holes (REF 02.02261.203 and 02.02261.303) is a product of BAAT Medical BV and is distributed by Zimmer only in Europe, Middle East, and Africa.

Graphic Case

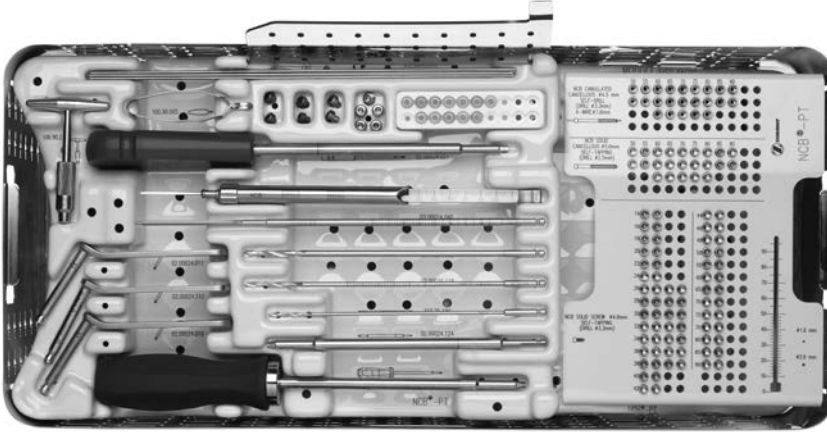

NCB® PT Standard Graphic Case
for open technique; includes
REF 02.00024.801/.802/.803/.804/
.805

REF
with content **ZS 02.00024.800**
empty ZS 02.00024.810

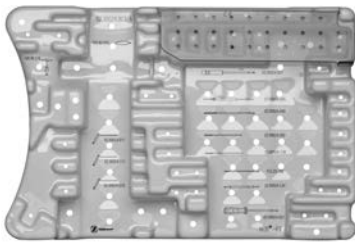

NCB® PT Graphic Case, module
instruments

REF
02.00024.803

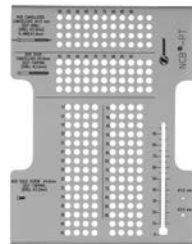

NCB® PT Graphic Case, module
screw rack

REF
02.00024.805

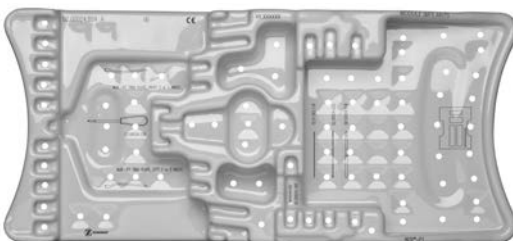

NCB® PT Graphic Case, module
cannulated screws and implants

REF
02.00024.804

NCB® PT Graphic Case, lid

REF
02.00024.801

NCB® PT Graphic Case base (Inox)

REF
02.00024.802

Standard Instruments



NCB® Drill Bit, with quick coupling

Quantity*	L mm	∅ mm	REF
1	195	4.3	02.00024.002



NCB® Depth Gauge

Quantity*	L mm	∅ mm	REF
1	110	5.0/4.5/4.0	02.00024.005



NCB® Drill Guide ∅ 2.5 mm for screws ∅ 5.0 cancellous

Quantity*	∅ mm	REF
1	2.5	02.00024.010



NCB® Drill Guide 4.3 screws 5.0

Quantity*	mm	REF
1	4.3	02.00024.011



NCB® Torque Screwdriver, 6 Nm

Quantity*	L mm	∅ mm	REF
1	280	3.5	02.00024.021



NCB® PT Hexagonal Screwdriver, long

Quantity*	L mm	∅ mm	REF
1	275	3.5	02.00024.124



NCB® PT Tab 4 mm, with quick coupling

Quantity*	mm	REF
1	4.0	02.00024.040



NCB® Drill Guide ∅ 3.3 mm for screws ∅ 4.0/4.5

Quantity*	∅ mm	REF
1	3.3	02.00024.111



NCB® Drill Bit, with quick coupling

Quantity*	L mm	mm	REF
1	195	3.3	02.00024.118



NCB® PT Hexagonal Screwdriver, shaft

Quantity*	L mm	∅ mm	REF
1	–	3.5	02.00024.027



Screw forceps self-holding

Quantity*	REF
1	100.90.005



T-handle, with quick coupling

Quantity*	REF
1	100.90.210

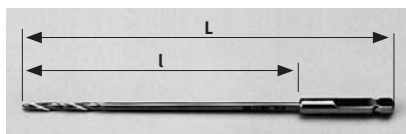

Two-fluted drill bit, with quick coupling

Quantity*	L mm	l mm	∅ mm	REF
1	180	154	2.5	103.25.180



Kirschner wire, stainless steel

Quantity*	L mm	mm	REF
5	280	2.0	290.20.280

*Indicates the quantity in the standard graphic case.

MIS Instruments

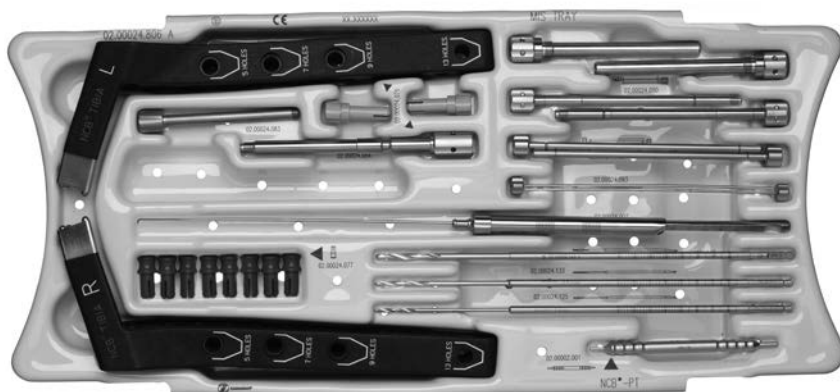

NCB® PT Graphic Case, for
MIS instruments

	REF
with content	ZS 02.00024.850
empty	02.00024.806



Assembly pin

Quantity**	REF
1	02.00002.001



NCB® PT Depth Gauge

Quantity**	REF
1	02.00024.007



Safety lock pin for targeting device

Quantity**	REF
2	02.00024.076



NCB® Screw Marker for targeting device

Quantity**	REF
8	02.00024.077

**Indicates the quantity in the MIS graphic case module.



NCB® PT Targeting Device

Quantity**	Side	REF
1	right	02.00024.080
1	left	02.00024.081



NCB® PT Soft Tissue Protection sleeve Ø 10.0/8.2 mm

Quantity**	REF
2	02.00024.090



NCB® PT Trocar

Quantity**	Ø mm	REF
2	2	02.00024.093

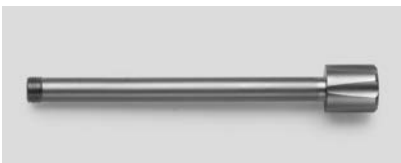

NCB® PT Connection Bolt

Quantity**	REF
1	02.00024.083



NCB® PT Drill Guide 8.2/5.2 mm

Quantity**	REF
2	02.00024.091



NCB® PT Drill Bit with quick coupling

Quantity**	Ø mm	REF
1	2.5	02.00024.125
1	3.3	02.00024.133
1	4.3	02.00024.143



NCB® PT Stabilization Bolt for targeting device

Quantity**	REF
1	02.00024.084



NCB® PT K-Wire Guide Ø 5.2/2 mm

Quantity**	REF
2	02.00024.092

**Indicates the quantity in the MIS graphic case module.

Cannulated Options (Screws and Instruments)

Cannulated Screws and Instrument Set

REF

ZS 02.00024.840

NCB® Cannulated Cancellous Screw
 Ø 4.5 mm, self-drill 24 mm thread length

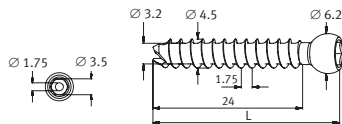

Quantity***	L mm	Ø mm	mm	REF (Non Sterile)	REF (Sterile)
2	50	4.5	3.5	02.03158.050	02.02158.050
2	55	4.5	3.5	02.03158.055	02.02158.055
3	60	4.5	3.5	02.03158.060	02.02158.060
3	65	4.5	3.5	02.03158.065	02.02158.065
3	70	4.5	3.5	02.03158.070	02.02158.070
3	75	4.5	3.5	02.03158.075	02.02158.075
3	80	4.5	3.5	02.03158.080	02.02158.080
2	85	4.5	3.5	02.03158.085	02.02158.085
2	90	4.5	3.5	02.03158.090	02.02158.090
–	95	4.5	3.5	02.03158.095	–
–	100	4.5	3.5	02.03158.100	–

Materials: NCB Plates and Screws are made of Ti6Al4V, ISO 5832-3, ASTM F136



NCB® PH Guide Wire with threaded tip

Quantity***	L mm	mm	REF
5	190	1.6	02.01362.116



NCB® PH/PT Measuring Device for cannulated screws

Quantity***	REF
1	02.00024.219



NCB® PH Hexagonal Screwdriver
 cannulated short hex

Quantity***	L mm	mm	REF
1	245	3.5	02.00024.120

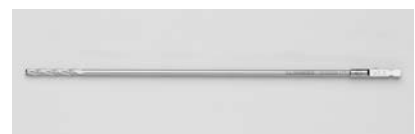

NCB® PT Cannulated Drill Bit with quick coupling

Quantity***	Ø mm	REF
1	3.3	02.00024.233

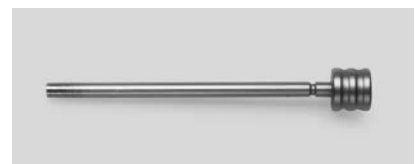

NCB® PT Drill Guide 3.3/1.6 mm

Quantity***	REF
2	02.00024.192

*** Indicates the quantity of instruments / non sterile implants included in the Ref. Number ZS 02.00024.840

Planning Aid

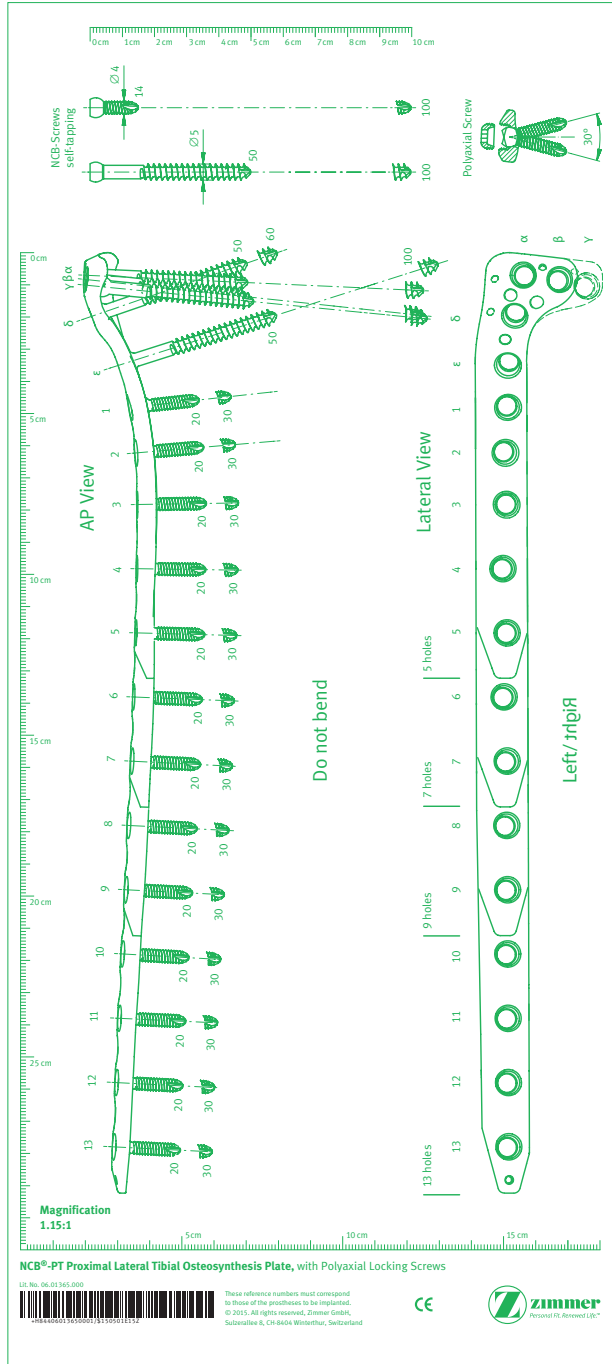

X ray template REF 06.01365.000

Disclaimer

This documentation is intended exclusively for physicians and is not intended for laypersons. Information on the products and procedures contained in this document is of a general nature and does not represent and does not constitute medical advice or recommendations. Because this information does not purport to constitute any diagnostic or therapeutic statement with regard to any individual medical case, each patient must be examined and advised individually, and this document does not replace the need for such examination and/or advice in whole or in part.

Please refer to the package inserts for important product information, including, but not limited to, indications, contraindications, warnings, precautions, and adverse effects.

Contact your Zimmer representative or visit us at www.zimmer.com



Lit. No. 06.01369.022 – Ed. 2015-08



+H84406013690221/S150826H15D