

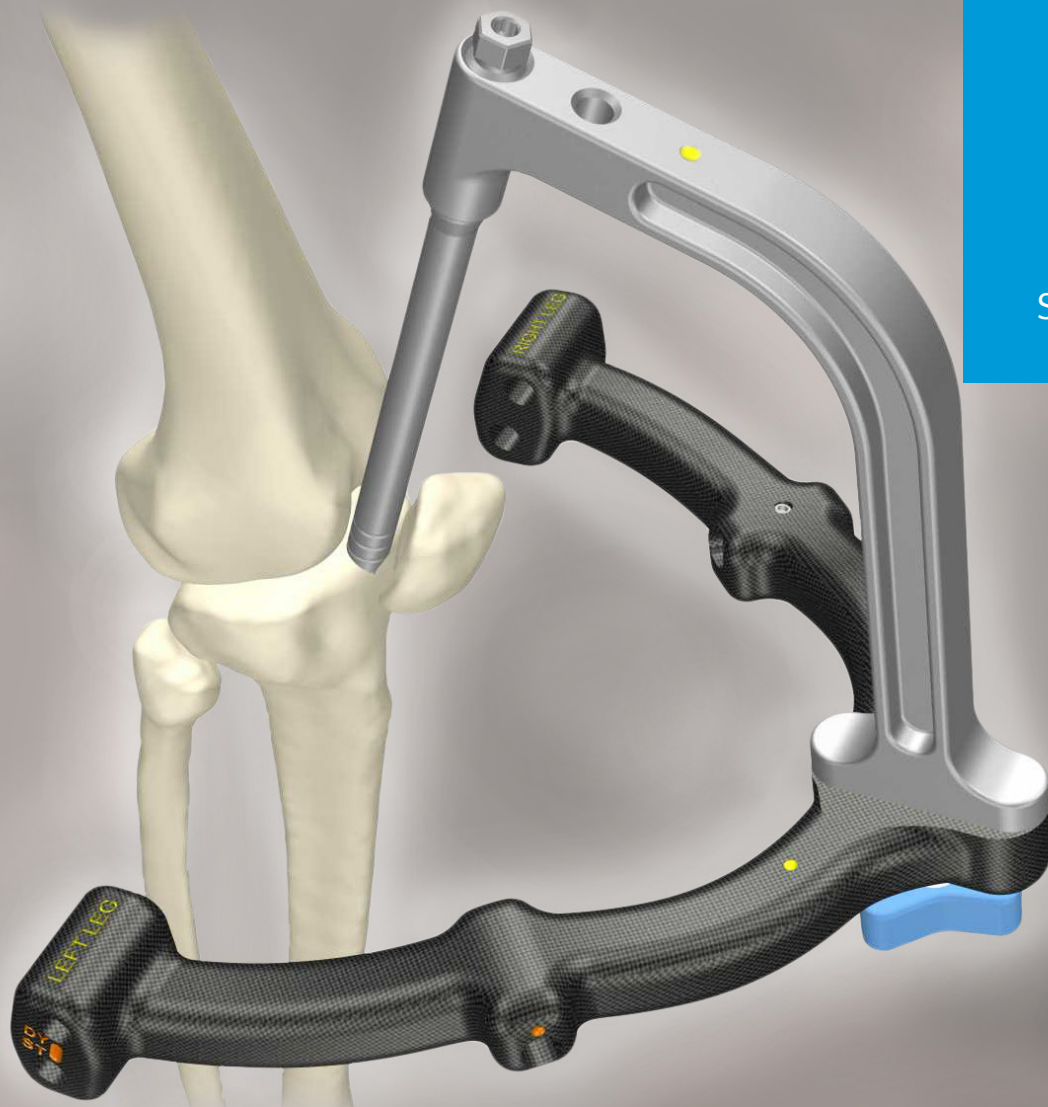

Zimmer® Natural Nail® System

Tibial Nail Surgical
Suprapatella Technique



**Zimmer Natural Nail
System Tibial Nail
Surgical Technique
(Suprapatella)**

Table of Contents	
Product Overview	2
Implant Overview	2
Indications	2
Contraindications	2
Surgical Technique	3
Preoperative Planning	3
Patient Positioning	3
Reduction	3
Starting Point Location	3
Reaming	6
Nail Assembly and Insertion	6
Proximal Screw Placement	9
Distal Targeting – Freehand Technique	11
Finalize Implant Placement	13
Postoperative Care	13
Nail Extraction	13
Tibial Nail Details	14
Case Examples	15
Product Information	16

Product Overview

The *Zimmer Natural Nail System* is a system of intramedullary nails, screws, instruments and other associated implants that are designed to provide stable internal fixation for fractured long bones. The nails have been designed for specific applications to help restore the shape of the fractured bone to its natural, pre-injured state.

The Tibial Nail is designed to help treat various fractures of the tibia. Screws are placed through the nail to secure the implant in place and maintain length and alignment while healing occurs. The nail has multiple screw holes in the proximal body to allow surgeons to address different fracture types. The proximal slot allows for compression or dynamization across a fracture.

A choice of lengths and diameters is available to match the individual anatomy of the patient.

Implant Overview

Nail Diameters: 8.3, 9.3, 10, 11, 12mm

Nail Lengths: 24 to 44cm in 2cm increments

Proximal Screw Diameter: 5.0mm

Proximal Screw Lengths: 20 to 60mm in 2.5mm increments, 65 to 100mm in 5mm increments

Distal Screw Diameter: 4.0mm for 8.3mm diameter nails

5.0mm for 9.3mm and larger diameter nails

Distal Screw Lengths: 20 to 60mm in 2.5mm increments, 65 to 100mm in 5mm increments

Materials: Ti-6Al-4V alloy

Precision instrumentation is provided to help implant the nail. Many of the instruments and implants feature color coding to help the surgical team use the system, easily and efficiently. Certain universal instruments are not color coded. The color coding system is referenced in the technique. A wall chart (97-2495-003-00) is also available to help explain the color coding system.

The technique is written to explain use of the SUPRAPATELLA TARGETING GUIDE which should be used when the knee is in extension.

Indications

The *Zimmer Natural Nail System* is intended for temporary fracture fixation and stabilization of the bone.

Indications for the tibial nails include the following:

- Compound and simple shaft fractures
- Proximal, metaphyseal and distal shaft fractures
- Segmental fractures
- Comminuted fractures
- Fractures involving osteopenic and osteoporotic bone
- Pathological fractures
- Fractures with bone loss
- Periprosthetic fractures
- Pseudoarthrosis, non-union, mal-union and delayed union
- Surgically created defects such as osteotomies

When this device is implanted using a Suprapatella surgical approach, all of the above indications apply with the exception of Periprosthetic Fractures.

Contraindications

- A medullary canal obliterated by a previous fracture or tumor
- Bone shaft having excessive bow or deformity
- Lack of bone substance or bone quality which makes stable seating of the implant impossible
- All concomitant diseases that can impair the functioning and the success of the implant
- Infection
- Insufficient blood circulation
- Skeletally immature patients

WARNING: This nail should only be used to treat a periprosthetic fracture if the in situ device is firmly fixed and if the Suprapatella surgical approach is not being used for implantation. When treating a periprosthetic fracture, the nail should be positioned so that it does not come in contact with the in situ device.

Surgical Technique

Preoperative Planning

Preoperative planning is recommended before beginning the surgical procedure. A/P and Lateral x-rays of the injured tibia should be taken preoperatively and evaluated for length, canal size and implant suitability. A/P and Lateral x-rays of the contralateral uninjured tibia can also be taken preoperatively to provide insight into the characteristics of the pre-injured tibia.

Patient Positioning

The patient should be positioned in the supine position. The positioning should allow the knee of the injured leg to be placed in at least 10°-20° of flexion. Use e.g. blankets, custom foam devices or sterile bumps to support this position.

The use of a fracture table can be beneficial to help reduce fractures as well as to facilitate intraoperative imaging with a C-arm. The C-arm should be placed to allow for imaging of the tibia in both planes along the entire length of the bone.

Drape the patient appropriately to allow the surgeon to work from the knee to the foot.

Reduction

It is critical to achieve anatomic reduction before beginning any of the steps to place the IM Nail. Traction should be used as necessary to help achieve fracture reduction. Several instruments are available to assist in fracture reduction including clamps, ball spike pushers and Steinman pins, femoral distractors or external fixation systems.

Starting Point Location

The starting point for the nail is located on the shelf of the tibia, just medial to the Lateral Intracondylar Eminence (Fig. 1). Avoid an excessively medial start point to minimize potential for intra-articular damage. With the knee in full extension, make a 2cm longitudinal skin incision either starting at the pole of the patella or starting 1cm superior (corresponds to one finger breadth) to the pole of the patella.

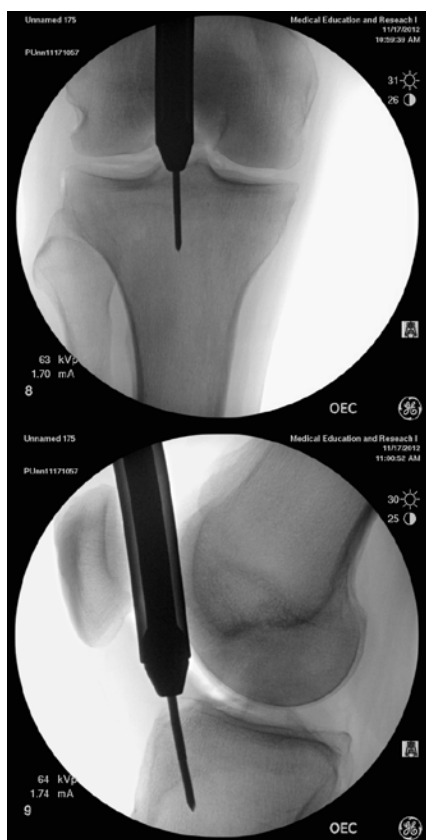
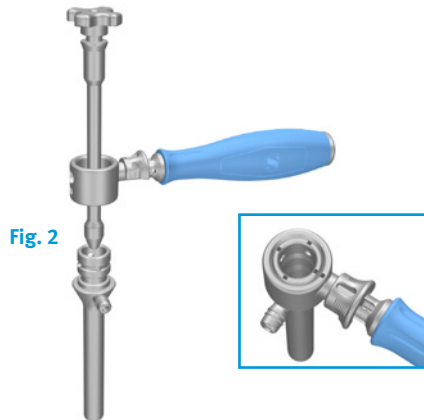

Fig. 1

The deep incision, also longitudinal, splits the quadriceps tendon in its midsubstance, just above its insertion into the patella and enters the knee joint through the suprapatellar pouch.



Blunt dissection can be used to loosen the patella in the suprapatellar pouch, allowing the patella to lift off. Displace the patella anteriorly.

Assemble the ENTRY CANNULA with the corresponding blue ENTRY CANNULA HANDLE (Fig. 2). Orient the laser mark on the handle to any laser mark on the cannula.

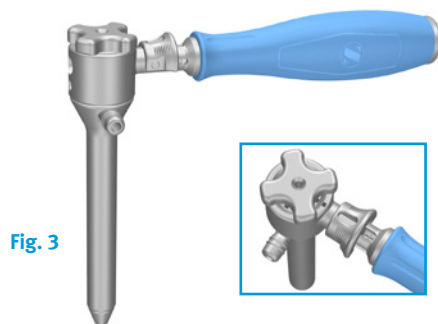

Insert the CANNULATED TROCAR into the handle assembly. Push down on and lock the inner instruments to make sure that everything is properly put together (Fig. 3).

NOTE: Inspect the ENTRY CANNULA as it may become damaged, bend or chipped with excessive prior reaming and insertion of any other instruments. Any flaws in the tube can lead to damage of the surrounding tendons and tissues.

CAUTION: Do not use ENTRY CANNULA without trocar properly assembled or directly with the STARTING POINT MODIFIER attached.

Insert the handle assembly through the incision into the knee joint so that it glides between the articular surface of the patella and the trochlea of the distal femur and rests securely in this groove, while the patella is displaced anteriorly. When the CANNULATED TROCAR reaches the surface of the tibia stop pushing down the handle assembly.

NOTE: The knee must remain in extension or slightly flexed once the handle assembly has been inserted.

Pin Insertion

Place the 3.0mm PIN through the CANNULATED TROCAR and advance to the anterior surface of the tibia (Fig. 4). Slight adjustment of the knee flexion (between 10°-20°) will provide the ideal radiographic location for the starting point and insertion of the PIN into the tibia.

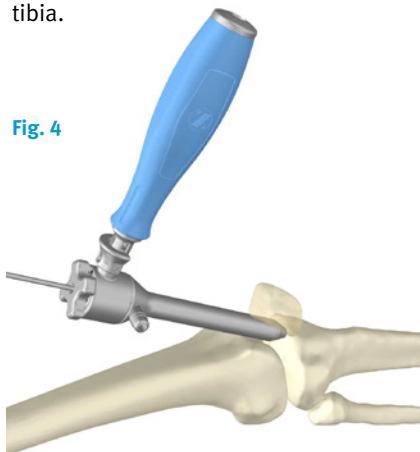

Use the C-arm to visualize the pin's position from A/P and Lateral views. The PIN should be inserted at the identified point heading slightly posterior into the medullary canal.

Drive the pin through the starting point into the center of the medullary canal. Adjustments to the PIN location can be

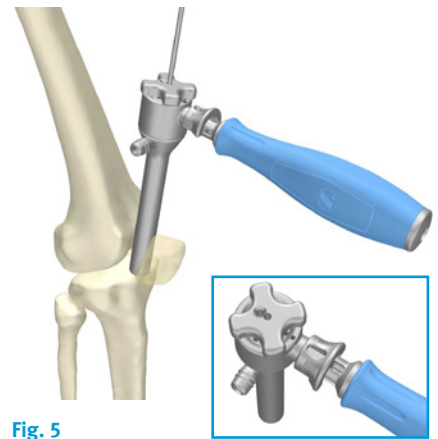

Fig. 5

made by replacing the CANNULATED TROCAR by the STARTING POINT MODIFIER (Fig. 5). Rotate it to place a second PIN while the first PIN remains in place. Distance between the two pins is 4mm. After correct placement of the second PIN the initial PIN and the STARTING POINT MODIFIER can be removed.

Once the ENTRY CANNULA is in place and the PIN position is verified, the CANNULATED TROCAR can be removed from the surgical field (Fig. 6). If needed, a standard suction device can be attached to the ENTRY CANNULA.

Place the 8mm ENTRY REAMER over the PIN, through the ENTRY CANNULA and down to the bone (Fig. 7). Using fluoroscopy, ream an entry portal into the proximal tibia to the metadiaphyseal flare. The PIN and the ENTRY REAMER should not reach the posterior cortex.

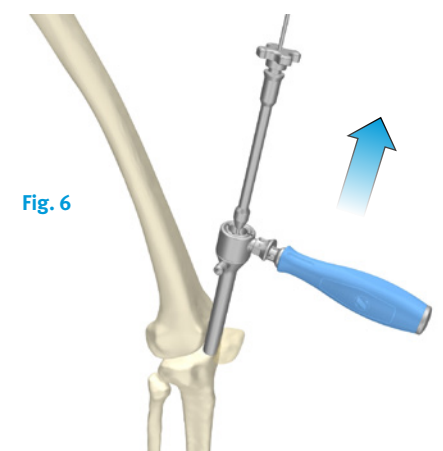

Fig. 6

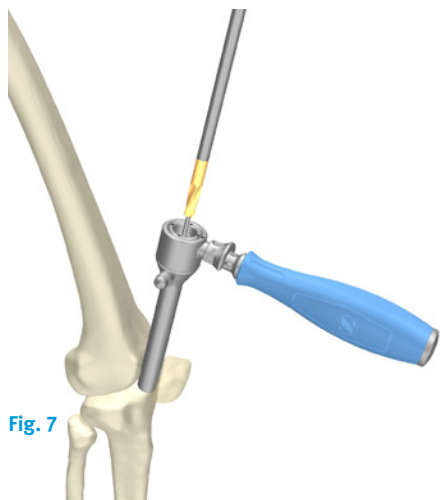

Fig. 7

Remove the ENTRY REAMER.

Alternatively, a STRAIGHT AWL or a 12mm ENTRY REAMER can be used to find the entry point and create the entry portal (Fig. 8).

NOTE: Do not use the STRAIGHT AWL with power. Always attach the MODULAR HANDLE to perform the opening of the IM canal.

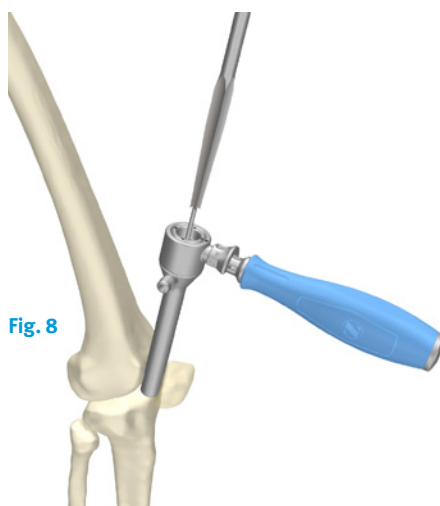

Fig. 8

Only nails up to 12mm may be used with this technique. If an 8mm entry reamer was used for proximal reaming, then use the 12.0mm ENTRY REAMER to finish preparing the proximal tibia for the proximal portion of the nail (sizes 8-11mm). If the bone is especially dense, it may be necessary to over-ream

the proximal tibia by 0.5 to 1.0mm to accommodate the proximal portion of the nail. The groove in the reamer flutes indicates the final position of the top of the nail. In addition, the c-arm should be used to visualize the depth of the reamer in the proximal tibia. Care should be taken to keep the reamer in line with the shaft of the tibia to avoid reaming through the cortex of the tibia.

Remove the pin.

Place a 3.0mm x 100cm BALL TIP GUIDE WIRE or TEAR DROP GUIDE WIRE through the ENTRY CANNULA into the medullary canal all the way into the distal tibia. To aid in manipulation, bend the tip of the GUIDE WIRE at about a 10° angle 5cm from the end.

CAUTION: If the GUIDE WIRE is bent shorter than 5cm from the end of the wire and/or more than 10 degrees it may be difficult to remove from the nail. If the wire becomes lodged inside the nail, utilize the GUIDE WIRE GRIPPER and mallet to remove the guide wire from the nail.

Fluoroscopy can assist you in guiding the GUIDE WIRE past the fracture site. If you plan to ream the canal of the tibia, the GUIDE WIRE should be centered and embedded in the distal tibia at the level of the distal epiphyseal scar using the GUIDE WIRE GRIPPER and a MALLET (Fig. 9). Care should be taken not to drive the wire through the ankle joint.

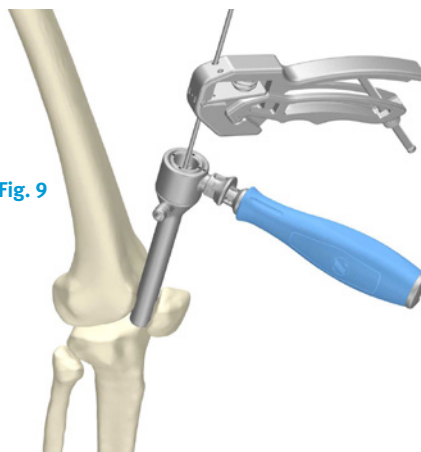

Fig. 9

Assemble the two piece NAIL LENGTH GAUGE. Slide the tube portion of the gauge over the 3.0mm x 100cm GUIDE WIRE until the tip of the tube is at the level of the entry point (confirm position using fluoroscopy) (Fig. 10).



Fig. 10

The proximal end of the GUIDE WIRE indicates the length of the wire in the canal (Fig. 11). When determining nail length, consideration should be taken as to how deep the nail will be inserted into the tibia based upon the desired location of the proximal screws. A RULER is also included in the set which can be used to radiographically determine nail length.



Fig. 11

If a 70cm GUIDE WIRE is used, measure the length of the canal by sliding only the half of the NAIL LENGTH GAUGE that is etched with length measurements to the level of the entry point. The proximal end of the 70cm GUIDE WIRE will indicate the length of the wire that is in the canal.

Reaming

Attach a standard suction device to the ENTRY CANNULA to remove reaming debris from the knee joint.

Insert the reamer over the GUIDE WIRE through the ENTRY CANNULA. Start with a small reamer. Increase the diameter of the reamer by 0.5 - 1.0mm depending on the amount of resistance felt while reaming.

NOTE: If the reamer head gets stuck in the IM canal or interferes with the ENTRY CANNULA, tilt the ENTRY CANNULA HANDLE to a anterior-inferior position to re-align the reamer head and ENTRY CANNULA (Fig. 12).

The GUIDE WIRE PUSHER can help prevent the GUIDE WIRE from coming out of the tibia during reaming. When cortical chatter occurs, stop reaming. Choose a nail that is 1.0 – 1.5mm smaller than the last reamer used. The proximal diameter of nails equal to or smaller than 11mm in diameter is 11mm. For nails 11mm and larger in diameter, the diameter of the nail is constant. If a nail smaller than 11mm is to be used, be sure to ream the proximal portion of the bone to 11.5mm to accommodate the proximal portion of the nail.

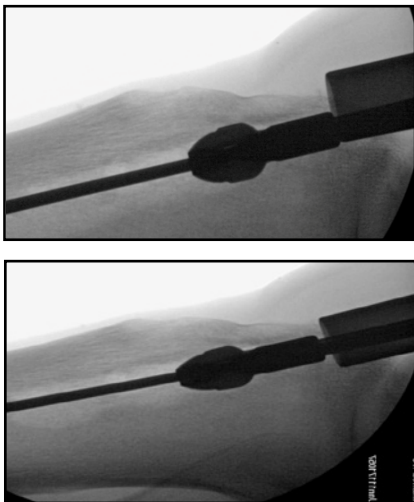

Fig. 12

NOTE: The ENTRY CANNULA allows reamers up to 13.5mm to go through. Do not use a larger reamer. Therefore nails with a diameter of 13mm or 14mm can't be utilized with the suprapatella instrumentation.

NOTE: If the GUIDE WIRE becomes lodged within the reamer, use the GUIDE WIRE PUSHER to push the GUIDE WIRE back into the IM canal.

Nail Assembly and Insertion

The color code for the tibial nail is YELLOW. Ti-6Al-4V alloy nails, the SUPRAPATELLAR TARGETING GUIDE and the CONNECTING BOLT all have yellow colors and the word YELLOW etched on them. Place the appropriate CONNECTING BOLT (Suprapatella) through the barrel of the LONG TARGETING GUIDE HANDLE. Begin threading the CONNECTING BOLT (by hand or using the CONNECTING BOLT INSERTER) into the proximal portion of the nail. Orient the nail so that the distal portion of the nail angles anterior, the same direction as the TARGETING GUIDE HANDLE (Fig. 13).



Fig. 13

Slots in the top of the nail will match tabs on the TARGETING GUIDE HANDLE to help orient the nail correctly. Completely tighten the CONNECTING BOLT to secure the nail to the guide (Fig. 14). The arrow on the nail will line up with the arrow on the barrel of the guide when the nail is correctly aligned.

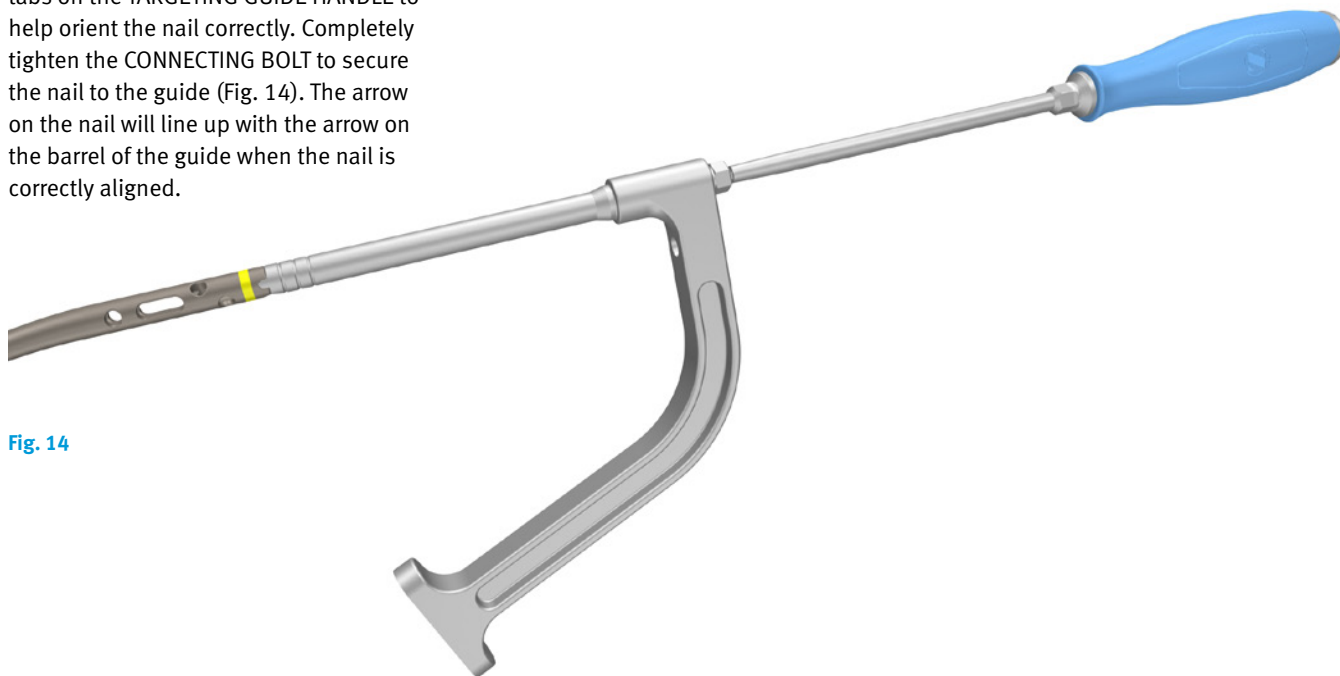

Fig. 14

Attach the TARGETING MODULE to the TARGETING GUIDE HANDLE. Use a screw cannula, drill sleeve and drill bit to verify that the holes in the guide target the holes in the nail. Remove the TARGETING MODULE **BEFORE** inserting the nail.

Insert the NAIL over the GUIDE WIRE with the arm of the guide facing anterior. Monitor the progression of the nail down the canal using the C-arm, especially as the nail is passing through or near the fracture site (Fig. 15).

NOTE: Before inserting the nail, the ENTRY CANNULA has to be removed as the nail will not pass through it.

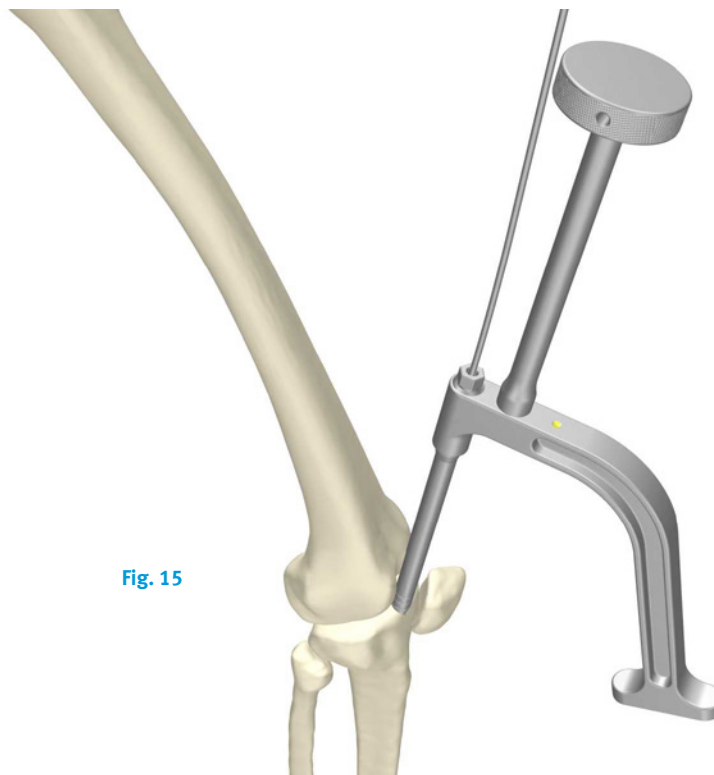
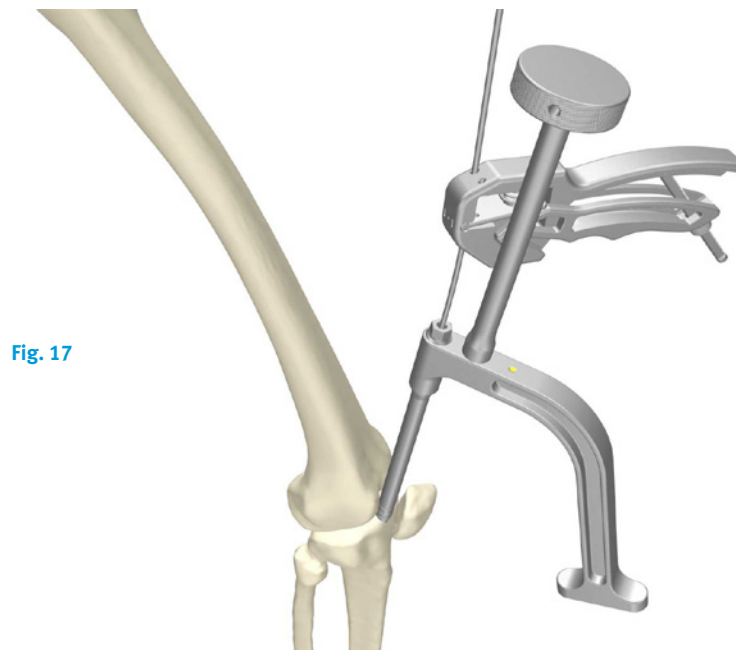
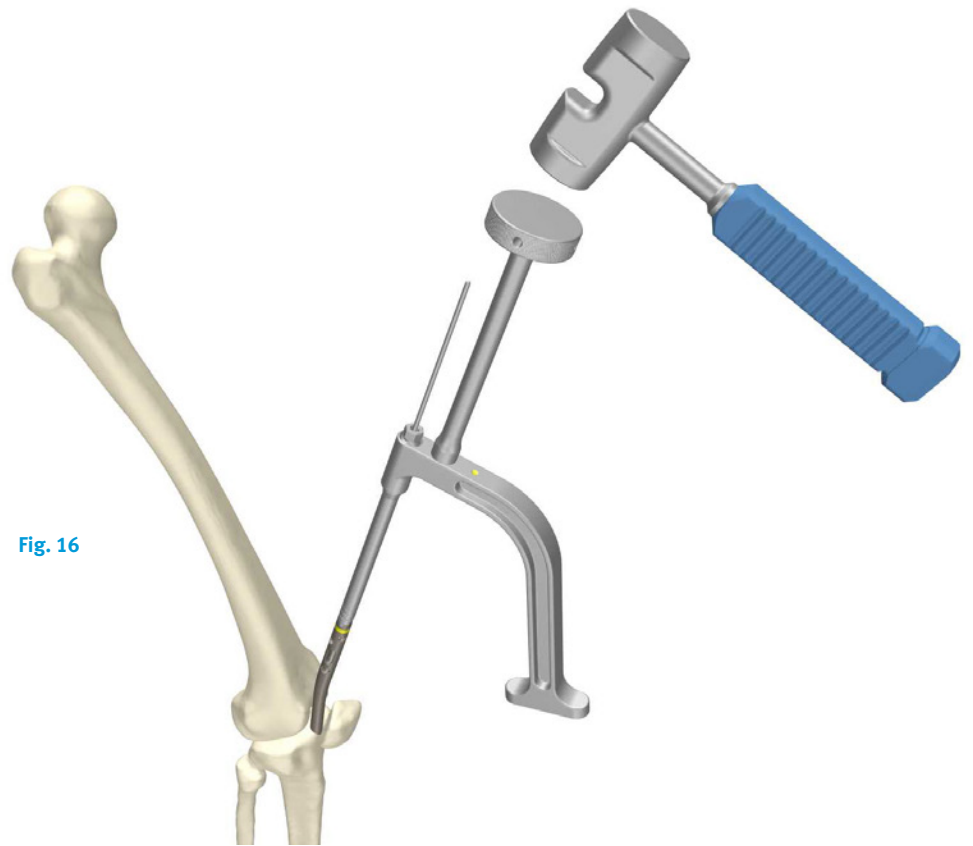

Fig. 15

If the nail does not pass down the canal easily, attach the IMPACTION HEAD to the TARGETING GUIDE HANDLE. Using the MALLET, impact gently on the IMPACTION HEAD (Fig. 16). Do not impact when the MODULE is attached to the IMPACTION HEAD. Verify that the CONNECTING BOLT is tight while impacting. Do not impact on any other portion of the TARGETING GUIDE HANDLE or MODULE as this may break the guide or cause it to lose its accuracy. If the nail will not advance with impaction, remove the nail and ream the canal to a larger diameter at additional 0.5 mm increments or consider using a smaller diameter nail. Place the top of the nail in line with or below the surface of the tibia, depending on its position relative to the expected screw location. Care should be taken to not pry on the handle as this may cause damage to the instrumentation.

Remove the GUIDE WIRE from the nail using the GUIDE WIRE GRIPPER (Fig. 17). **If possible, remove the GUIDE WIRE before fully seating the nail, if desired.**



Proximal Screw Placement

All of the screw holes in the tibial nail allow for standard locking or fixed angle locking. To achieve standard locking, choose a PARTIALLY THREADED SCREW. To achieve a fixed angle construct, choose a FIXED ANGLE SCREW.

Instruments that are specific to the tibia nail are marked in YELLOW. The instruments needed to place screws through the proximal portion of the nail are color coded ORANGE/ORANGE. These instruments are placed through holes in the targeting guide which are color coded ORANGE. The chart below details the color coded instruments that are used to target and place screws.

INSTRUMENT TYPE	COLOR CODE
Screw Cannula	Orange/Orange
Trocar	Orange/Orange
4.3mm Drill Sleeve	Orange/Orange & Red
4.3mm Drill Bit	Orange/Orange & Red
Depth Gauge	Orange
Screwdriver	Orange/Orange

Fig. 18

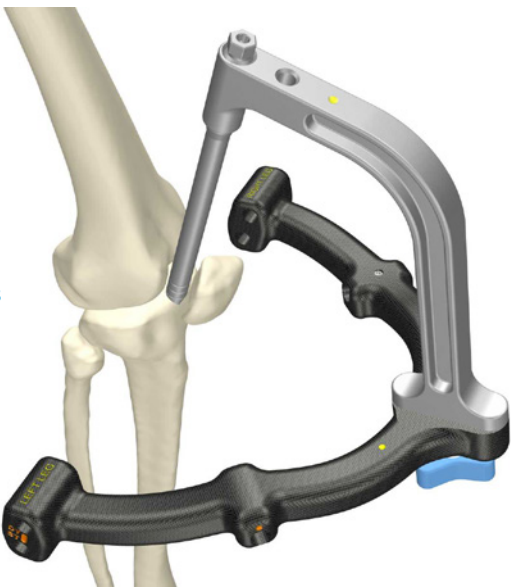

Retighten the CONNECTING BOLT to the nail.

Attach the TARGETING MODULE to the TARGETING GUIDE HANDLE (Fig. 18). Select the screw holes that will be used in the nail. Insert HOLE INDICATORS in the holes in the TARGETING MODULE that will NOT be used.

Slide the TROCAR into the SCREW CANNULA. Slide the SCREW CANNULA through one of the selected holes in the TARGETING MODULE. Dissect through the tissue down to the bone to make a path for the SCREW CANNULA (Fig. 19). Advance the SCREW CANNULA until the tip of the TROCAR is against the bone (Fig. 20).

Fig. 19

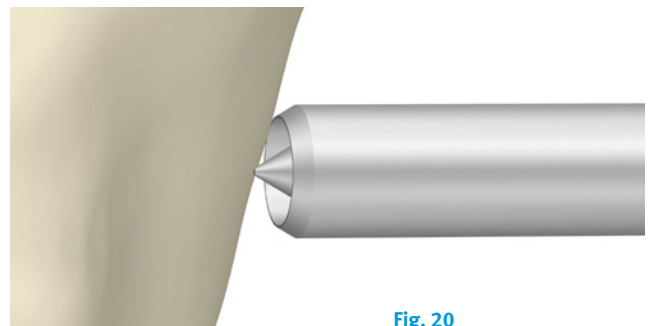
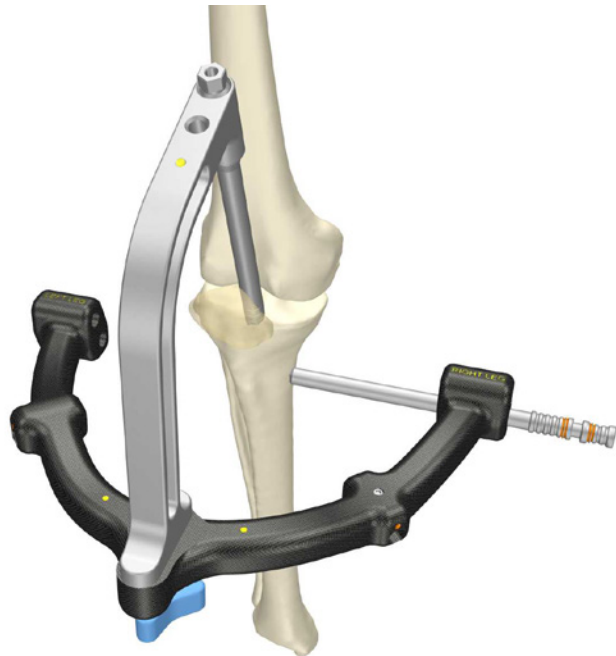

Fig. 20

*Under certain conditions, especially in patients with thin cortical bone, Partially Threaded Screws from 20mm to 32.5mm in length may form a Fixed Angle construct with the nail.

Remove the TROCAR. Insert the 4.3mm DRILL SLEEVE through the CANNULA down to the bone. Place the 4.3mm DRILL BIT through the DRILL SLEEVE. Before the DRILL BIT contacts the bone, start the drill. Advance the spinning DRILL BIT through the bone bicortically. Use fluoroscopy to verify the appropriate location of the DRILL BIT in the bone.

With the DRILL BIT in place and the DRILL SLEEVE pressed against the bone, the length of screw needed is indicated by the etch marks on the DRILL BIT where it exits the SCREW CANNULA (Fig. 21). The tip of the drill should be no more than 5mm through the far cortex of the bone to reduce the risk of complications associated with screw protrusion. (Alternatively, the DRILL BIT and DRILL SLEEVE can be removed and the SCREW DEPTH GAUGE used to measure the length of screw.)

Remove the DRILL BIT and DRILL SLEEVE. Place the appropriate length 5.0mm screw (color coded RED) through the SCREW CANNULA into the bone (Fig. 22).

Using the screwdriver, advance the screw to achieve bicortical purchase (the screw head should sit on the near cortex of the bone). The screws are self tapping so tapping should not be necessary (Fig. 23).

If using the CAPTURED SCREWDRIVER, place the appropriate screw on the 3.5mm HEX and tighten the screw to the CAPTURED SCREWDRIVER by turning the knob next to the handle clockwise.

CAUTION: If using the CAPTURED SCREWDRIVER, do not torque the CAPTURED SCREWDRIVER beyond the calibration line next to the handle.

CAUTION: Do not drive the screws into the bone under power, as damage to the bone, screws and nail could result.

Note: Do not overtighten the screws.

Repeat this technique to place additional proximal screws as necessary.



Fig. 21



Fig. 22

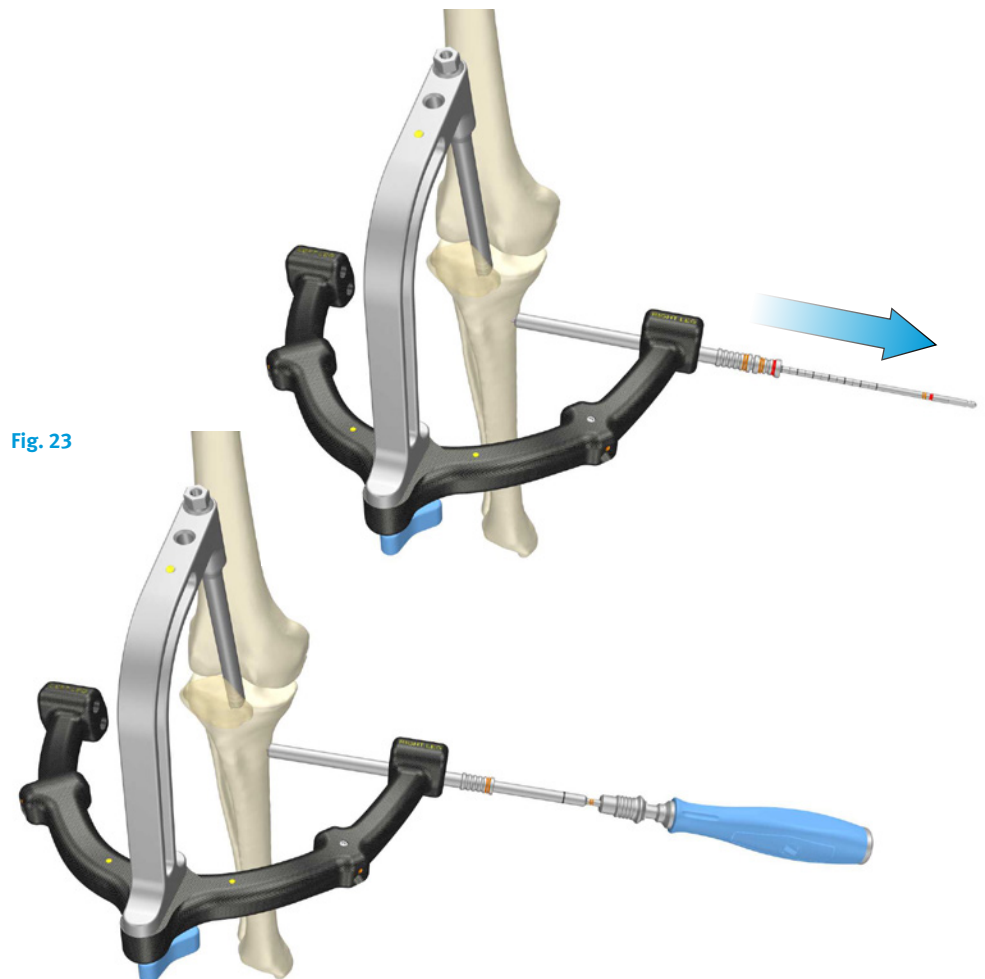

Fig. 23

Distal Targeting – Freehand Technique

8.3mm nails utilize a 4.0mm screw (3.3mm drill bit) distally. These items are color coded WHITE.

9.3mm and larger diameter nails use a 5.0mm screw (4.3mm drill bit) distally. These items are color coded RED.

NOTE: There is no color indication on the screw itself. Screw packaging and the screw case contain color coding to help identify the screw size.

Insert the appropriate diameter FREEHAND DRILL BIT into the DISTAL TARGETING WAND. Finger tighten the SET SCREW. Position the C-arm in order to get a lateral view of the distal tibia. Adjust the angle of the C-arm so that the hole through the nail appears as a perfect circle on the monitor. Bring the tip of the drill bit to the skin and use the C-arm to center it over the hole that you desire to place a screw through (Fig. 24).

Fig. 24

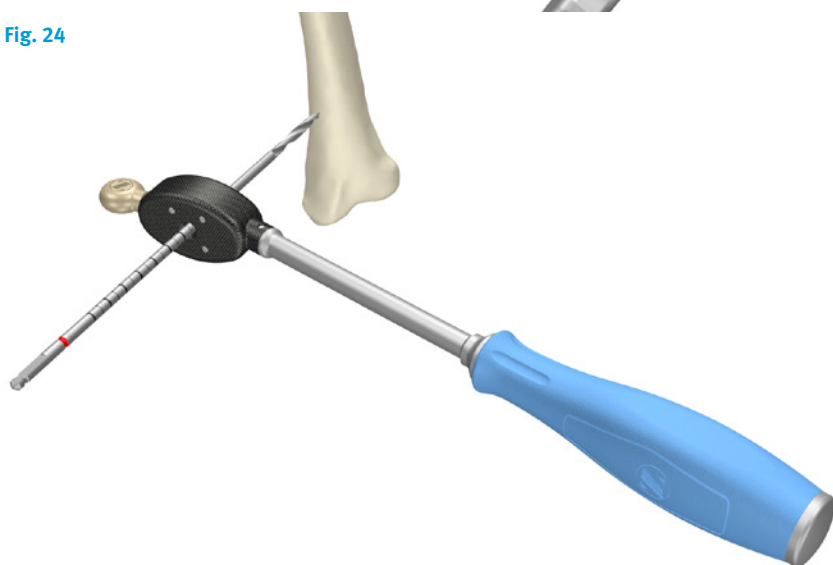

Make a stab incision at this point and dissect down to the bone. Place the tip of the drill bit against the bone. Verify that the tip of the drill bit is in the center of the hole. While keeping the tip of the drill bit against the bone, move the other end of the drill bit into other positions and take additional fluoroscopic images to verify the position of the tip in the center of the hole. Align the drill bit with the C-arm beam. Tap the drill bit into the bone using the MALLET.

Loosen the SET SCREW and remove the DISTAL TARGETING WAND, leaving the DRILL BIT in place. Slide the FREEHAND TISSUE PROTECTION SLEEVE over the DRILL BIT (Fig. 25).

Fig. 25

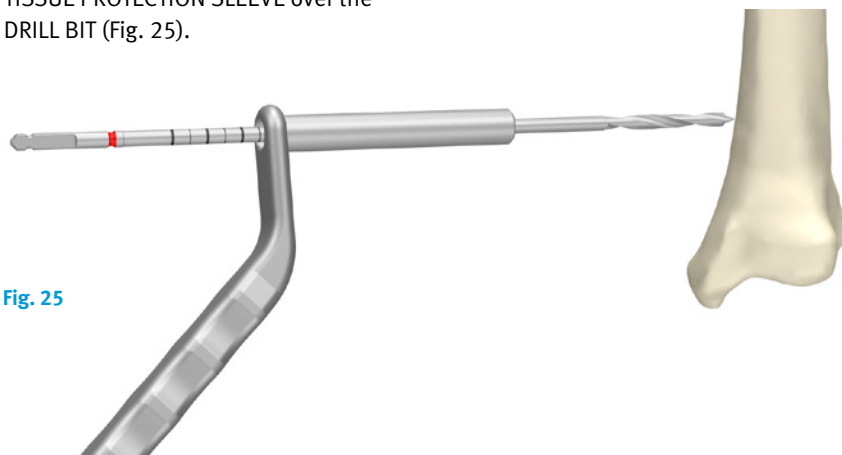

Attach the DRILL to the DRILL BIT and advance the drill bit through the bone. Verify that the drill bit has gone through the hole in the nail.

Remove the drill bit. Measure the depth of the hole using the FREEHAND SCREW DEPTH GAUGE (Fig. 26).

Alternatively, the appropriate length of screw can be measured using the numbered etch on the DRILL BIT closest to the end of the FREEHAND TISSUE PROTECTION SLEEVE when the DRILL BIT is in the bone and the SLEEVE is touching the bone (Fig. 27). Insert the appropriate length screw using the screwdriver.

If using the CAPTURED SCREWDRIVER, place the appropriate screw on the 3.5mm HEX and tighten the screw to the CAPTURED SCREWDRIVER by turning the knob next to the handle clockwise.

CAUTION: If using the CAPTURED SCREWDRIVER, do not torque the CAPTURED SCREWDRIVER beyond the calibration line next to the handle.

CAUTION: Do not drive the screws into the bone under power, as damage to the bone, screws and nail could result.

NOTE: Do not overtighten the screws.

Repeat these steps to insert additional distal screws.

Fig. 26

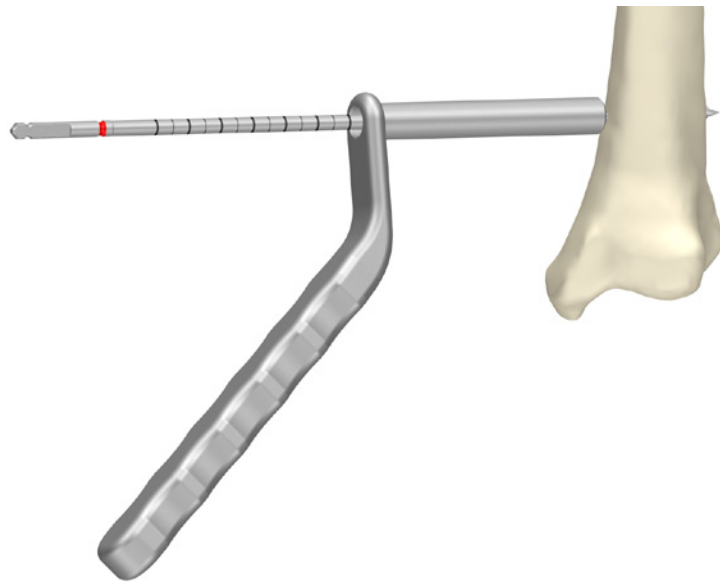
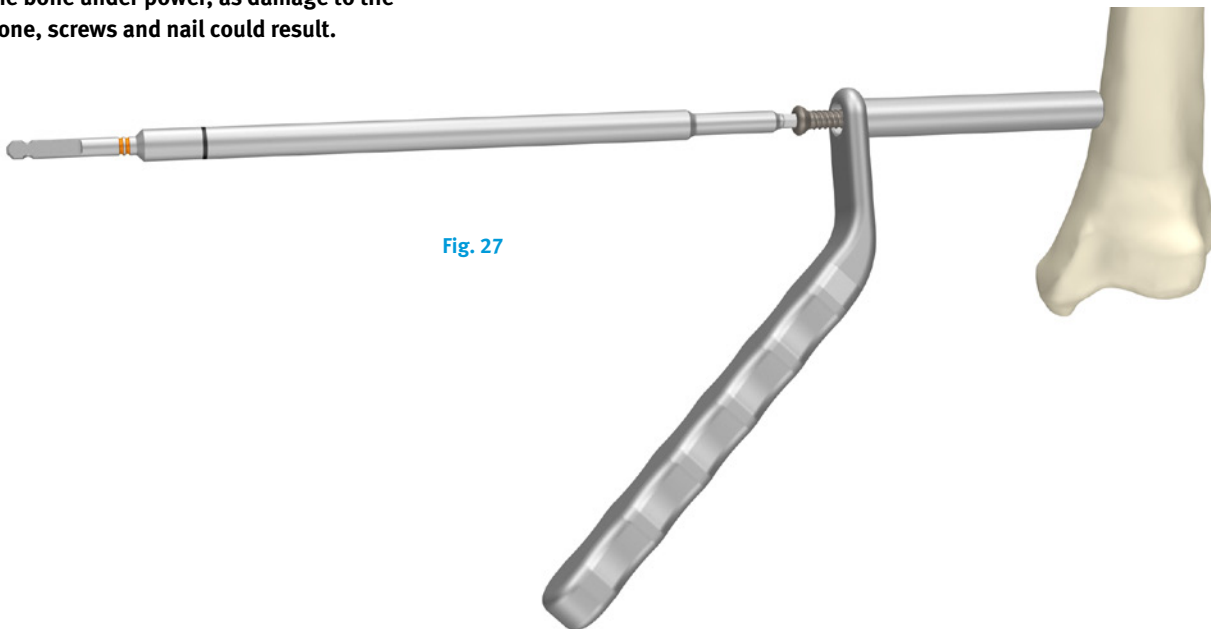

Fig. 27



Finalize Implant Placement

Observe the depth of the nail in proximal tibia. Ridges in the targeting guide barrel indicate depths of 5, 10 and 15mm.

Disconnect the TARGETING MODULE from the TARGETING GUIDE HANDLE and set aside. Place a 2.0MM PIN through the guide against the proximal screws. Loosen and remove the CONNECTING BOLT from the nail (Fig. 28). Remove the TARGETING GUIDE HANDLE and set aside.

Assemble the ENTRY CANNULA with the blue ENTRY CANNULA HANDLE and slide over 2.0MM PIN.

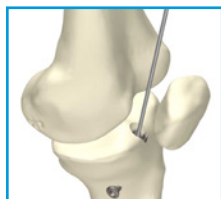

Fig. 28

Choose the appropriate height TIBIAL NAIL CAP. Secure the selected NAIL CAP to the NAIL CAP INSERTER using the NAIL CAP RETAINING SHAFT (Fig. 29). Slide the TIBIAL NAIL CAP over the 2.0MM PIN and tighten to the nail (Fig. 30). Using the C-arm, verify that the cap is completely seated to the top of the nail.

Disengage the NAIL CAP INSERTER from the TIBIAL NAIL CAP. Remove the 2.0MM GUIDE PIN.

Close all wounds and apply the appropriate dressings.

Postoperative Care

Early range of motion exercises of the knee and ankle are encouraged. Allow toe-touch weight bearing to progress to full weight bearing as fracture callus increases on the x-ray films.

Nail Extraction

Because of the potential for damage to intra-articular structures, use a standard parapatellar incision for any nail extractions. Do not extract the nail via a suprapatellar approach. Before attempting to remove any screws or nail caps, clean any bone from the hex of the screw or cap.

Use the C-arm to locate any distal screws. Remove the screws using a 3.5mm hex screwdriver. Remove the nail cap (if one was inserted) with the CONNECTING BOLT INSERTER or another Zimmer 5.0mm hex screwdriver. Expose the proximal screws and use a 3.5mm hex screwdriver to remove them.

NOTE: Use the specific captured screwdriver.

To remove the nail, slide a 2.0mm Guide Pin through the nail. Insert the CANNULATED EXTRACTION ADAPTER over the wire into the top of the nail. Tighten the adapter to the nail. Attach a saphammer or other impaction device and impact to back out the nail.



Fig. 29

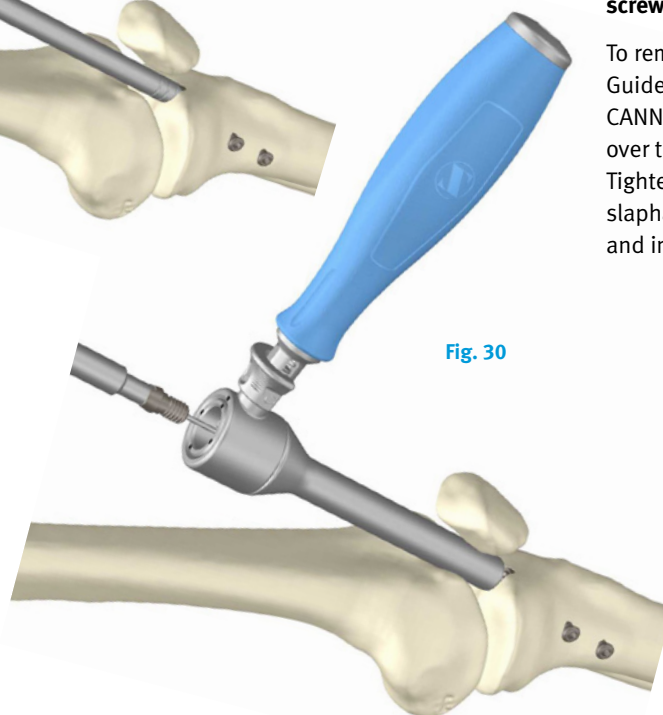
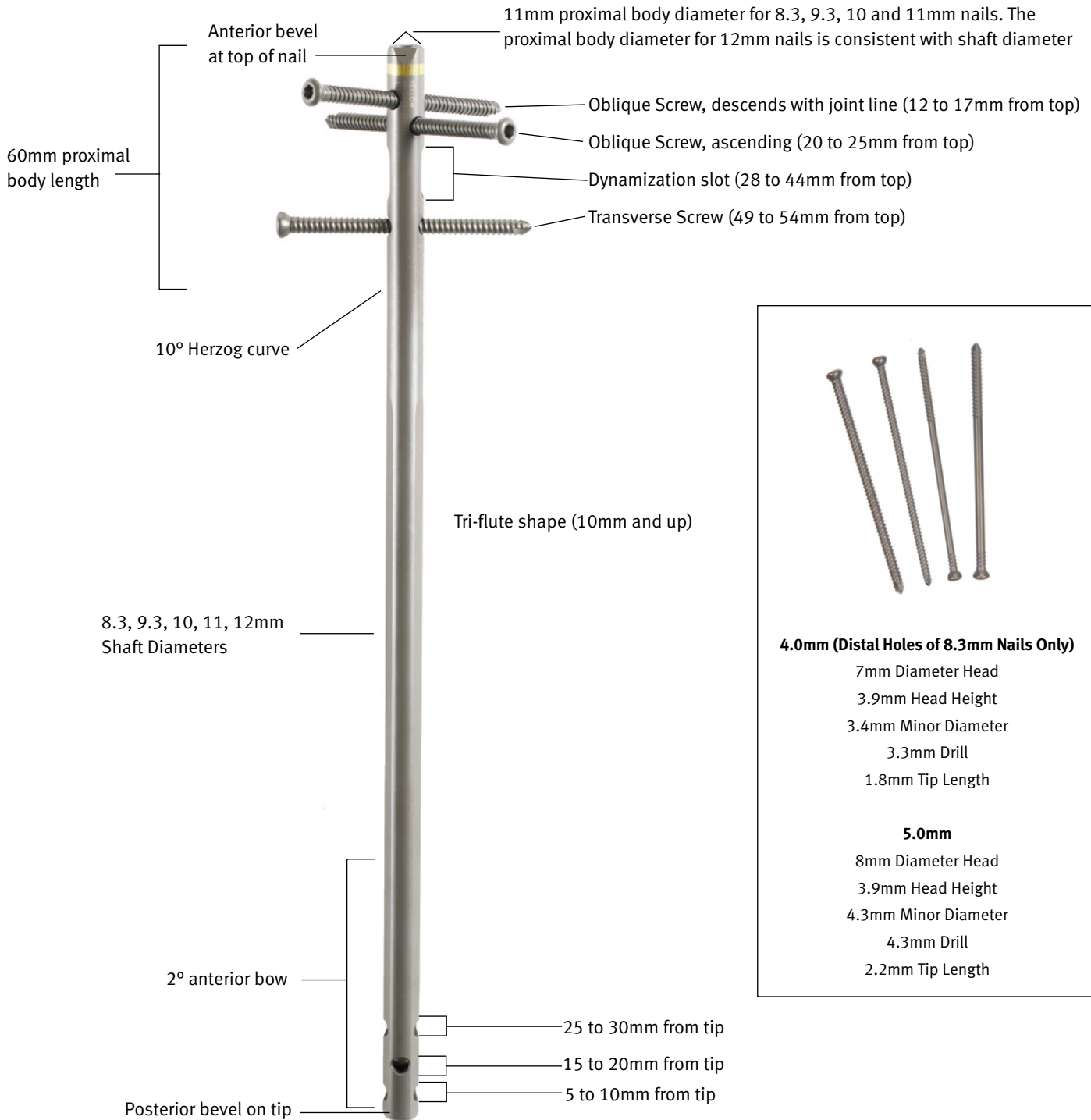

Fig. 30

Tibial Nail Details



4.0mm (Distal Holes of 8.3mm Nails Only)

- 7mm Diameter Head
- 3.9mm Head Height
- 3.4mm Minor Diameter
- 3.3mm Drill
- 1.8mm Tip Length

5.0mm

- 8mm Diameter Head
- 3.9mm Head Height
- 4.3mm Minor Diameter
- 4.3mm Drill
- 2.2mm Tip Length

Case Examples



Pre-Op



Post-Op



Pre-Op



Post-Op

Product Information

Tibial Nails

Item Number	Product Description
47-2495-240-08	Tibia Nail 8.3mm X 24cm Ti-6AL-4V Alloy
47-2495-260-08	Tibia Nail 8.3mm X 26cm Ti-6AL-4V Alloy
47-2495-280-08	Tibia Nail 8.3mm X 28cm Ti-6AL-4V Alloy
47-2495-300-08	Tibia Nail 8.3mm X 30cm Ti-6AL-4V Alloy
47-2495-320-08	Tibia Nail 8.3mm X 32cm Ti-6AL-4V Alloy
47-2495-340-08	Tibia Nail 8.3mm X 34cm Ti-6AL-4V Alloy
47-2495-360-08	Tibia Nail 8.3mm X 36cm Ti-6AL-4V Alloy
47-2495-380-08	Tibia Nail 8.3mm X 38cm Ti-6AL-4V Alloy
47-2495-400-08	Tibia Nail 8.3mm X 40cm Ti-6AL-4V Alloy
47-2495-420-08	Tibia Nail 8.3mm X 42cm Ti-6AL-4V Alloy
47-2495-440-08	Tibia Nail 8.3mm X 44cm Ti-6AL-4V Alloy
47-2495-240-09	Tibia Nail 9.3mm X 24cm Ti-6AL-4V Alloy
47-2495-260-09	Tibia Nail 9.3mm X 26cm Ti-6AL-4V Alloy
47-2495-280-09	Tibia Nail 9.3mm X 28cm Ti-6AL-4V Alloy
47-2495-300-09	Tibia Nail 9.3mm X 30cm Ti-6AL-4V Alloy
47-2495-320-09	Tibia Nail 9.3mm X 32cm Ti-6AL-4V Alloy
47-2495-340-09	Tibia Nail 9.3mm X 34cm Ti-6AL-4V Alloy
47-2495-360-09	Tibia Nail 9.3mm X 36cm Ti-6AL-4V Alloy
47-2495-380-09	Tibia Nail 9.3mm X 38cm Ti-6AL-4V Alloy
47-2495-400-09	Tibia Nail 9.3mm X 40cm Ti-6AL-4V Alloy
47-2495-420-09	Tibia Nail 9.3mm X 42cm Ti-6AL-4V Alloy
47-2495-440-09	Tibia Nail 9.3mm X 44cm Ti-6AL-4V Alloy
47-2495-240-10	Tibia Nail 10mm X 24cm Ti-6AL-4V Alloy
47-2495-260-10	Tibia Nail 10mm X 26cm Ti-6AL-4V Alloy
47-2495-280-10	Tibia Nail 10mm X 28cm Ti-6AL-4V Alloy
47-2495-300-10	Tibia Nail 10mm X 30cm Ti-6AL-4V Alloy
47-2495-320-10	Tibia Nail 10mm X 32cm Ti-6AL-4V Alloy
47-2495-340-10	Tibia Nail 10mm X 34cm Ti-6AL-4V Alloy
47-2495-360-10	Tibia Nail 10mm X 36cm Ti-6AL-4V Alloy
47-2495-380-10	Tibia Nail 10mm X 38cm Ti-6AL-4V Alloy
47-2495-400-10	Tibia Nail 10mm X 40cm Ti-6AL-4V Alloy
47-2495-420-10	Tibia Nail 10mm X 42cm Ti-6AL-4V Alloy
47-2495-440-10	Tibia Nail 10mm X 44cm Ti-6AL-4V Alloy
47-2495-240-11	Tibia Nail 11mm X 24cm Ti-6AL-4V Alloy
47-2495-260-11	Tibia Nail 11mm X 26cm Ti-6AL-4V Alloy
47-2495-280-11	Tibia Nail 11mm X 28cm Ti-6AL-4V Alloy
47-2495-300-11	Tibia Nail 11mm X 30cm Ti-6AL-4V Alloy
47-2495-320-11	Tibia Nail 11mm X 32cm Ti-6AL-4V Alloy
47-2495-340-11	Tibia Nail 11mm X 34cm Ti-6AL-4V Alloy
47-2495-360-11	Tibia Nail 11mm X 36cm Ti-6AL-4V Alloy
47-2495-380-11	Tibia Nail 11mm X 38cm Ti-6AL-4V Alloy
47-2495-400-11	Tibia Nail 11mm X 40cm Ti-6AL-4V Alloy
47-2495-420-11	Tibia Nail 11mm X 42cm Ti-6AL-4V Alloy
47-2495-440-11	Tibia Nail 11mm X 44cm Ti-6AL-4V Alloy
47-2495-240-12	Tibia Nail 12mm X 24cm Ti-6AL-4V Alloy
47-2495-260-12	Tibia Nail 12mm X 26cm Ti-6AL-4V Alloy
47-2495-280-12	Tibia Nail 12mm X 28cm Ti-6AL-4V Alloy
47-2495-300-12	Tibia Nail 12mm X 30cm Ti-6AL-4V Alloy
47-2495-320-12	Tibia Nail 12mm X 32cm Ti-6AL-4V Alloy
47-2495-340-12	Tibia Nail 12mm X 34cm Ti-6AL-4V Alloy
47-2495-360-12	Tibia Nail 12mm X 36cm Ti-6AL-4V Alloy
47-2495-380-12	Tibia Nail 12mm X 38cm Ti-6AL-4V Alloy
47-2495-400-12	Tibia Nail 12mm X 40cm Ti-6AL-4V Alloy
47-2495-420-12	Tibia Nail 12mm X 42cm Ti-6AL-4V Alloy
47-2495-440-12	Tibia Nail 12mm X 44cm Ti-6AL-4V Alloy

4.0mm Screws (Partially Threaded) (for distal screw holes on nails 8.3mm nail)

All Screws have a 3.5mm Hex Head

Item Number	Product Description
47-2483-020-40	4.0mm Cortical Screw 20mm Length
47-2483-022-40	4.0mm Cortical Screw 22.5mm Length
47-2483-025-40	4.0mm Cortical Screw 25mm Length
47-2483-027-40	4.0mm Cortical Screw 27.5mm Length
47-2483-030-40	4.0mm Cortical Screw 30mm Length
47-2483-032-40	4.0mm Cortical Screw 32.5mm Length
47-2483-035-40	4.0mm Cortical Screw 35mm Length
47-2483-037-40	4.0mm Cortical Screw 37.5mm Length
47-2483-040-40	4.0mm Cortical Screw 40mm Length
47-2483-042-40	4.0mm Cortical Screw 42.5mm Length
47-2483-045-40	4.0mm Cortical Screw 45mm Length
47-2483-047-40	4.0mm Cortical Screw 47.5mm Length
47-2483-050-40	4.0mm Cortical Screw 50mm Length
47-2483-052-40	4.0mm Cortical Screw 52.5mm Length
47-2483-055-40	4.0mm Cortical Screw 55mm Length
47-2483-057-40	4.0mm Cortical Screw 57.5mm Length
47-2483-060-40	4.0mm Cortical Screw 60mm Length
47-2483-065-40	4.0mm Cortical Screw 65mm Length
47-2483-070-40	4.0mm Cortical Screw 70mm Length
47-2483-075-40	4.0mm Cortical Screw 75mm Length
47-2483-080-40	4.0mm Cortical Screw 80mm Length
47-2483-085-40	4.0mm Cortical Screw 85mm Length
47-2483-090-40	4.0mm Cortical Screw 90mm Length
47-2483-095-40	4.0mm Cortical Screw 95mm Length
47-2483-100-40	4.0mm Cortical Screw 100mm Length

Fixed Angle (Fully Threaded)

Item Number	Product Description
47-2484-020-40	4.0mm Cortical Screw 20mm Length
47-2484-022-40	4.0mm Cortical Screw 22.5mm Length
47-2484-025-40	4.0mm Cortical Screw 25mm Length
47-2484-027-40	4.0mm Cortical Screw 27.5mm Length
47-2484-030-40	4.0mm Cortical Screw 30mm Length
47-2484-032-40	4.0mm Cortical Screw 32.5mm Length
47-2484-035-40	4.0mm Cortical Screw 35mm Length
47-2484-037-40	4.0mm Cortical Screw 37.5mm Length
47-2484-040-40	4.0mm Cortical Screw 40mm Length
47-2484-042-40	4.0mm Cortical Screw 42.5mm Length
47-2484-045-40	4.0mm Cortical Screw 45mm Length
47-2484-047-40	4.0mm Cortical Screw 47.5mm Length
47-2484-050-40	4.0mm Cortical Screw 50mm Length
47-2484-052-40	4.0mm Cortical Screw 52.5mm Length
47-2484-055-40	4.0mm Cortical Screw 55mm Length
47-2484-057-40	4.0mm Cortical Screw 57.5mm Length
47-2484-060-40	4.0mm Cortical Screw 60mm Length
47-2484-065-40	4.0mm Cortical Screw 65mm Length
47-2484-070-40	4.0mm Cortical Screw 70mm Length
47-2484-075-40	4.0mm Cortical Screw 75mm Length
47-2484-080-40	4.0mm Cortical Screw 80mm Length
47-2484-085-40	4.0mm Cortical Screw 85mm Length
47-2484-090-40	4.0mm Cortical Screw 90mm Length
47-2484-095-40	4.0mm Cortical Screw 95mm Length
47-2484-100-40	4.0mm Cortical Screw 100mm Length

5.0mm Screws (Partially Threaded)**(for all proximal screw holes and distal screw holes on nails 9.3mm and larger)**

Item Number	Product Description
47-2483-020-50	5.0mm Cortical Screw 20mm Length
47-2483-022-50	5.0mm Cortical Screw 22.5mm Length
47-2483-025-50	5.0mm Cortical Screw 25mm Length
47-2483-027-50	5.0mm Cortical Screw 27.5mm Length
47-2483-030-50	5.0mm Cortical Screw 30mm Length
47-2483-032-50	5.0mm Cortical Screw 32.5mm Length
47-2483-035-50	5.0mm Cortical Screw 35mm Length
47-2483-037-50	5.0mm Cortical Screw 37.5mm Length
47-2483-040-50	5.0mm Cortical Screw 40mm Length
47-2483-042-50	5.0mm Cortical Screw 42.5mm Length
47-2483-045-50	5.0mm Cortical Screw 45mm Length
47-2483-047-50	5.0mm Cortical Screw 47.5mm Length
47-2483-050-50	5.0mm Cortical Screw 50mm Length
47-2483-052-50	5.0mm Cortical Screw 52.5mm Length
47-2483-055-50	5.0mm Cortical Screw 55mm Length
47-2483-057-50	5.0mm Cortical Screw 57.5mm Length
47-2483-060-50	5.0mm Cortical Screw 60mm Length
47-2483-065-50	5.0mm Cortical Screw 65mm Length
47-2483-070-50	5.0mm Cortical Screw 70mm Length
47-2483-075-50	5.0mm Cortical Screw 75mm Length
47-2483-080-50	5.0mm Cortical Screw 80mm Length
47-2483-085-50	5.0mm Cortical Screw 85mm Length
47-2483-090-50	5.0mm Cortical Screw 90mm Length
47-2483-095-50	5.0mm Cortical Screw 95mm Length
47-2483-100-50	5.0mm Cortical Screw 100mm Length

Fixed Angle (Fully Threaded)

Item Number	Product Description
47-2484-020-50	5.0mm Cortical Screw 20mm Length
47-2484-022-50	5.0mm Cortical Screw 22.5mm Length
47-2484-025-50	5.0mm Cortical Screw 25mm Length
47-2484-027-50	5.0mm Cortical Screw 27.5mm Length
47-2484-030-50	5.0mm Cortical Screw 30mm Length
47-2484-032-50	5.0mm Cortical Screw 32.5mm Length
47-2484-035-50	5.0mm Cortical Screw 35mm Length
47-2484-037-50	5.0mm Cortical Screw 37.5mm Length
47-2484-040-50	5.0mm Cortical Screw 40mm Length
47-2484-042-50	5.0mm Cortical Screw 42.5mm Length
47-2484-045-50	5.0mm Cortical Screw 45mm Length
47-2484-047-50	5.0mm Cortical Screw 47.5mm Length
47-2484-050-50	5.0mm Cortical Screw 50mm Length
47-2484-052-50	5.0mm Cortical Screw 52.5mm Length
47-2484-055-50	5.0mm Cortical Screw 55mm Length
47-2484-057-50	5.0mm Cortical Screw 57.5mm Length
47-2484-060-50	5.0mm Cortical Screw 60mm Length
47-2484-065-50	5.0mm Cortical Screw 65mm Length
47-2484-070-50	5.0mm Cortical Screw 70mm Length
47-2484-075-50	5.0mm Cortical Screw 75mm Length
47-2484-080-50	5.0mm Cortical Screw 80mm Length
47-2484-085-50	5.0mm Cortical Screw 85mm Length
47-2484-090-50	5.0mm Cortical Screw 90mm Length
47-2484-095-50	5.0mm Cortical Screw 95mm Length
47-2484-100-50	5.0mm Cortical Screw 100mm Length

Nail Caps

Item Number	Product Description
47-2487-005-00	Tibial Nail Cap 0mm Height
47-2487-005-05	Tibial Nail Cap 5mm Height
47-2487-005-10	Tibial Nail Cap 10mm Height
47-2487-005-15	Tibial Nail Cap 15mm Height

Instruments**KT-2490-005-00 – SMALL Tibia Nail Instrument Set**

Item Number	Product Description		
02.00020.049	Ratchet Wrench 11mm	00-2490-035-75	Freehand Modular 3.5mm Hex Screwdriver
00-2237-008-00	Skin Protector	00-2490-046-20	2.0mm Pin
00-2490-000-14	Connecting Knob	00-2490-012-30	3.0mm Threaded Pin
00-2490-000-30	Nail Diameter Gauge	00-2490-046-32	Guide Pin Inserter / Extractor
00-2490-000-33	Ruler	00-2490-050-00	Modular Handle AO
00-2490-000-34	Nail Length Gauge	00-2490-050-02	Modular T-Handle
00-2490-000-41	Hole Indicator	00-2490-051-80	Screw Cannula 8.0mm
00-2490-005-01	Small Tibial Connecting Bolt	00-2490-052-80	Screw Trocar 8.0mm
00-2490-005-05	Tibial Module	00-2490-053-43	Tibial Drill Sleeve 4.3mm
00-2490-005-10	Tibial Targeting Guide Small Handle	00-2490-054-43	Calibrated Drill 4.3mm Tibial
00-2490-005-49	Tibial Axial Compression Device	00-2490-065-80	Short Screw Depth Gauge 8.0mm
00-2490-010-01	Short Cannulated Awl	00-2490-070-00	Freehand Targeting Wand
00-2490-010-02	7mm Diameter Awl - Angled Tip	00-2490-070-01	Targeting Wand Set Screw
00-2490-012-00	Guide Wire Gripper	00-2490-072-33	3.3mm Freehand Targeting Drill
00-2490-014-80	Entry Reamer 8mm	00-2490-072-43	4.3mm Freehand Targeting Drill
00-2490-017-00	Guide Wire Pusher	00-2490-073-00	Freehand Targeting Depth Gauge
00-2490-031-00	Connecting Bolt Inserter	00-2490-074-00	Freehand Tissue Protection Sleeve
00-2490-031-05	11mm Hex/ Pin Wrench	00-2490-080-00	Nail Cap Inserter
00-2490-032-00	Impaction Head	00-2490-080-03	Nail Cap Retaining Shaft
00-2490-032-01	Slotted Mallet	00-2490-090-00	Cannulated Extraction Adapter 5/16"
00-2490-033-00	Slap Hammer Adapter	00-5900-099-00	Case Lid
00-2490-035-50	Modular Screwdriver 3.5mm Hex		
00-2490-035-62	Short 3.5mm Hex Screwdriver - Captured		
00-2490-035-72	Freehand 3.5mm Hex Screwdriver - Captured		

KT-2490-005-01 – TALL Tibia Nail Instrument Set

Item Number	Product Description
02.00020.049	Ratchet Wrench 11mm
00-2237-008-00	Skin Protector
00-2490-000-14	Connecting Knob
00-2490-000-30	Nail Diameter Gauge
00-2490-000-33	Ruler
00-2490-000-34	Nail Length Gauge
00-2490-000-41	Hole Indicator
00-2490-005-05	Tibial Module
00-2490-005-07	Tall Tibial Connecting Bolt
00-2490-005-13	Tibia Targeting Guide Tall Handle
00-2490-005-49	Tibial Axial Compression Device
00-2490-010-01	Short Cannulated Awl
00-2490-010-02	7mm Diameter Awl - Angled Tip
00-2490-012-00	Guide Wire Gripper
00-2490-014-80	Entry Reamer 8mm
00-2490-017-00	Guide Wire Pusher
00-2490-031-00	Connecting Bolt Inserter
00-2490-031-05	11mm Hex / Pin Wrench
00-2490-032-00	Impaction Head
00-2490-032-01	Slotted Mallet
00-2490-033-00	Slap Hammer Adapter
00-2490-035-50	Modular Screwdriver 3.5mm Hex
00-2490-035-62	Short 3.5mm Hex Screwdriver - Captured
00-2490-035-72	Freehand 3.5mm Hex Screwdriver - Captured
00-2490-035-75	Freehand Modular 3.5mm Hex Screwdriver
00-2490-046-20	2.0mm Pin
00-2490-012-30	3.0mm Threaded Pin
00-2490-046-32	Guide Pin Inserter / Extractor
00-2490-050-00	Modular Handle AO
00-2490-050-02	Modular T-Handle

00-2490-051-80	Screw Cannula 8.0mm
00-2490-052-80	Screw Trocar 8.0mm
00-2490-053-43	Tibial Drill Sleeve 4.3mm
00-2490-054-43	Calibrated Drill 4.3mm Tibial
00-2490-065-80	Short Screw Depth Gauge 8.0mm
00-2490-070-00	Freehand Targeting Wand
00-2490-070-01	Targeting Wand Set Screw
00-2490-072-33	3.3mm Freehand Targeting Drill
00-2490-072-43	4.3mm Freehand Targeting Drill
00-2490-073-00	Freehand Targeting Depth Gauge
00-2490-074-00	Freehand Tissue Protection Sleeve
00-2490-080-00	Nail Cap Inserter
00-2490-080-03	Nail Cap Retaining Shaft
00-2490-090-00	Cannulated Extraction Adapter 5/16"
00-5900-099-00	Case Lid

KT-2490-005-10 Suprapatellar Add-on Instrument Set

Item Number	Product Description
00-2490-005-21	Long Tibial Connecting Bolt
00-2490-005-20	Long Tibial Targeting Guide Handle
00-2490-010-06	Modular Straight Awl, cannulated
00-2490-013-05	Long Tibial Entry Cannula, Locking
00-2490-013-06	Starting Point Modifier, Locking
00-2490-051-20	Cannulated Trocar, Locking
00-2490-013-07	Long Tibial Entry Cannula Handle
00-5900-099-00	Case Lid

Instrument Cases (Select both “Stainless Steel” or both “Stainless Steel and Aluminum” Cases)

Item Number	Product Description
00-2490-075-50	Tibial Case 1 of 2 – Stainless Steel and Aluminum
00-2490-079-50	Tibial Case 2 of 2 – Stainless Steel and Aluminum
00-2490-075-00	Tibial Case 1 of 2 – Stainless Steel
00-2490-079-00	Tibial Case 2 of 2 – Stainless Steel
00-2490-075-20	Suprapatella Tibia Instrument Add-on Case

Optional Instruments

Item Number	Product Description
00-2490-014-12	Entry Reamer 12mm

Tear Drop Guide Wire (available separately)

Item Number	Product Description
47-2490-097-00	3.0mm x 100cm Tear Drop Guide Wire (Sterile)
47-2490-097-01	2.4mm x 100cm Tear Drop Guide Wire (Sterile)
47-2490-098-00	3.0mm x 70cm Tear Drop Guide Wire (Sterile)
47-2490-098-01	2.4mm x 70cm Tear Drop Guide Wire (Sterile)

KT-2490-020-00 – Reduction Instrument Set

Item Number	Product Description
00-2490-020-30	3.0mm Self Drilling Reduction Pin
00-2490-020-50	5.0mm Self Drilling Reduction Pin
00-2490-021-00	Ball Spike Pusher
00-2490-022-01	Bone Clamp
00-2490-022-02	Verbrugge Clamp
00-2490-022-03	Reduction Tong
00-2490-025-24	Bone Hook Small - 24mm
00-2490-025-34	Bone Hook Large - 34mm
00-2490-026-00	Reduction Rod
00-2490-050-00	Modular T-Handle AO
00-2490-060-50	Reduction Base and Tray
00-5900-099-00	Case Lid

Surgical Technique Lit. No. 97-2495-009-00**Wall Chart Lit. No.** 97-2495-003-00**X-ray Templates Lit. No.** 97-2495-050-00

DISCLAIMER:

This documentation is intended exclusively for physicians and is not intended for laypersons. Information on the products and procedures contained in this document is of a general nature and does not represent and does not constitute medical advice or recommendations. Because this information does not purport to constitute any diagnostic or therapeutic statement with regard to any individual medical case, each patient must be examined and advised individually, and this document does not replace the need for such examination and/or advise in whole or in part.

Please refer to the package inserts for important product information, including, but not limited to, indications, contraindications, warnings, precautions, and adverse effects.

Contact your Zimmer representative or visit us at www.zimmer.com

The CE mark is valid only if it is also printed on the product label.

