

OSS™ Orthopedic Salvage System

Proximal and Total Femoral Replacement

Surgical Technique



Table of Contents

- Indications for Use** 5
- Bone Preparation** 9
- Trialing – Proximal Femur** 21
- Implant Assembly – Proximal Femur** 29
- Trialing – Total Femur** 45
- Implant Assembly – Total Femur** 49

This brochure is presented to demonstrate the surgical technique utilized by John A. Abraham, MD; Mr. Lee M. Jeys; Michael D. Miller, MD; Jeffrey R. Kneisl, MD; Robert J. Tait, MD and Edward J. McPherson, MD.

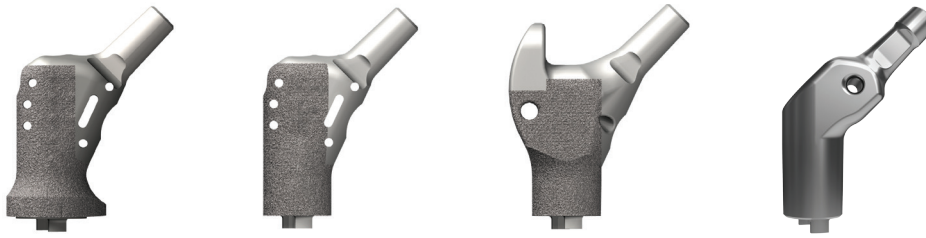

7 cm Proximal Femoral Components



Soft Tissue Bolt and Claw



OsseoTi Augments

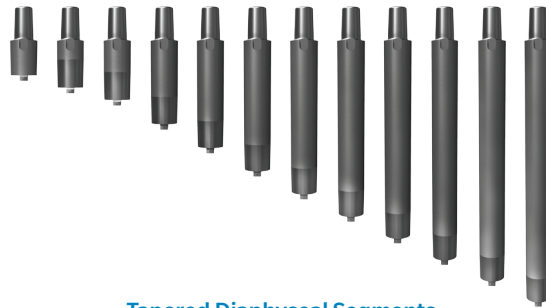

Tapered Diaphyseal Segments



OsseoTi Augments



Stems

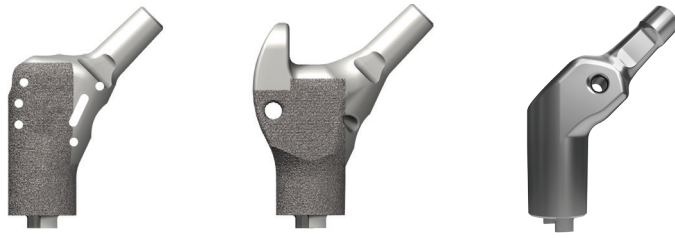

7 cm Proximal Femoral Components



Soft Tissue Bolt and Claw



OsseoTi Augments



Total Femoral Coupler

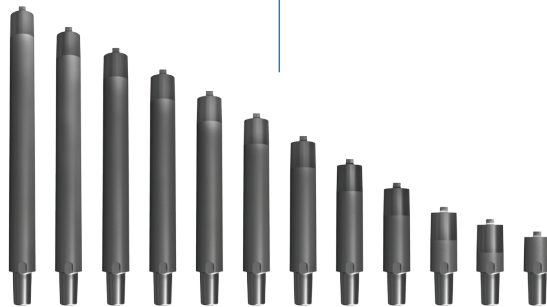

Tapered Diaphyseal Segments

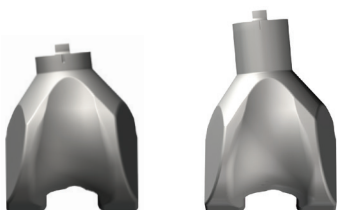

Standard 7 cm & 8.5 cm Distal Femurs

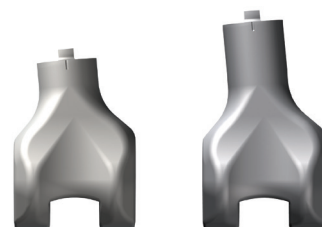

RS 7 cm & 8.5 cm Distal Femurs

Indications for Use

Indications and Contraindications

Effective as of January 1, 2016

INDICATIONS

1. Painful and disabled joint resulting from avascular necrosis, osteoarthritis, rheumatoid arthritis, or traumatic arthritis.
2. Correction of varus, valgus, or posttraumatic deformity.
3. Correction of revision of unsuccessful osteotomy, arthrodesis or previous joint replacement.
4. Ligament deficiencies.
5. Tumor resections.
6. Treatment of non-unions, femoral neck fracture, and trochanteric fractures of the proximal femur with head involvement, unmanageable using other techniques.*
7. Revision of previously failed total joint arthroplasty.
8. Trauma.

These devices are to be used with bone cement unless composed of OsseoTi[®] titanium alloy (not licensed in Canada) or a proximal femur is indicated for use (USA).

Legacy Biomet OSS Reduced size (RS) components offers a variety of component options for treatment in small adults and adolescents (12-21 years) that require proximal femoral, distal femoral, total femur, or proximal tibial replacement as well as, resurfacing components for the proximal tibia and distal femur (USA).

*Not applicable to Regenerex[®] Ultra Porous Construct titanium knee augment usage (not licensed in Canada), or any other knee component.

COMPRESS INDICATIONS

The Compress[®] Segmental Femoral Replacement System is indicated for:

1. Correction of revision of unsuccessful osteotomy, arthrodesis, or previous joint replacement.
2. Tumor resections.
3. Revision of previously failed total joint arthroplasty.
4. Trauma.

The Compress Segmental Femoral Replacement System components are intended for uncemented use.

When components of the Orthopaedic Salvage System are used with legacy Biomet's Compress Segmental Femoral Replacement System, the user should refer to the package insert contained with the Compress components for full prescription information.

CONTRAINDICATIONS

Absolute contraindications include: infection, sepsis, and osteomyelitis. Relative contraindications include: 1) uncooperative patient or patient with neurologic disorders who are incapable of following directions, 2) osteoporosis, 3) metabolic disorders which may impair bone formation, 4) osteomalacia, 5) distant foci of infections which may spread to the implant site, 6) rapid joint destruction, marked bone loss or bone resorption apparent on roentgenogram, 7) vascular insufficiency, muscular atrophy, or neuromuscular disease.

Bone Preparation

Pre-operative Planning

When planning for a proximal femoral replacement or a Total Femoral Replacement utilizing the Orthopaedic Salvage System, carefully review the indications and contraindications for use referenced within the package insert and located on page 5 of this surgical technique.

To determine the correct implant components and size, utilize the Proximal Femoral Resection Chart 1 on the next page. Final determination frequently cannot be made until the actual time of surgery, however with appropriate planning a consistent operative plan with alternatives can be formulated.

Chart 1: Proximal Femoral Resection

Resection Length (cm)	Proximal Femoral Components (cm)	Segmental Adapter		Segments												
		1 cm	1.5 cm	3 cm	4 cm	5 cm	7 cm	9 cm	11 cm	13 cm	15 cm	17 cm	19 cm	21 cm	23 cm	
30	7															23
29.5	7		1.5													21
29	7							9		13						
28.5	7		1.5					9	11							
28	7															21
27.5	7		1.5											19		
27	7							9	11							
26.5	7		1.5					(9+9)								
26	7													19		
25.5	7		1.5										17			
25	7							(9+9)								
24.5	7		1.5				7	9								
24	7												17			
23.5	7		1.5									15				
23	7						7	9								
22.5	7		1.5				(7+7)									
22	7											15				
21.5	7		1.5								13					
21	7						(7+7)									
20.5	7		1.5			5	7									
20	7										13					
19.5	7		1.5							11						
19	7					5	7									
18.5	7		1.5			(5+5)										
18	7									11						
17.5	7		1.5					9								
17	7					(5+5)										
16.5	7		1.5		(4+4)											
16	7							9								
15.5	7		1.5				7									
15	7				(4+4)											
14.5	7		1.5	(3+3)												
14	7						7									
13.5	7		1.5			5										
13	7			(3+3)												
12.5	7		1.5		4											
12	7					5										
11.5	7		1.5	3												
11	7				4											
10	7			3												
8.5	7		1.5													
8	7	1														
7	7 Elliptical Finn															

Additional options not presented exist if using collared stems or stem adapters.

Note: Collared stems add 1 cm extramedullary. Segmental adapters add either 1 cm or 1.5 cm extramedullary and adds 30 mm intramedullary.



Figure 1



Figure 2

Measuring Resection Length

Place the proximal femoral template on the femur and identify a resection length based on corresponding engravings (Figure 1).

Mark the resection point on the femur and make a longitudinal anterior mark (Figure 2). The reference corresponds with the markings on the trials and implant constructs.



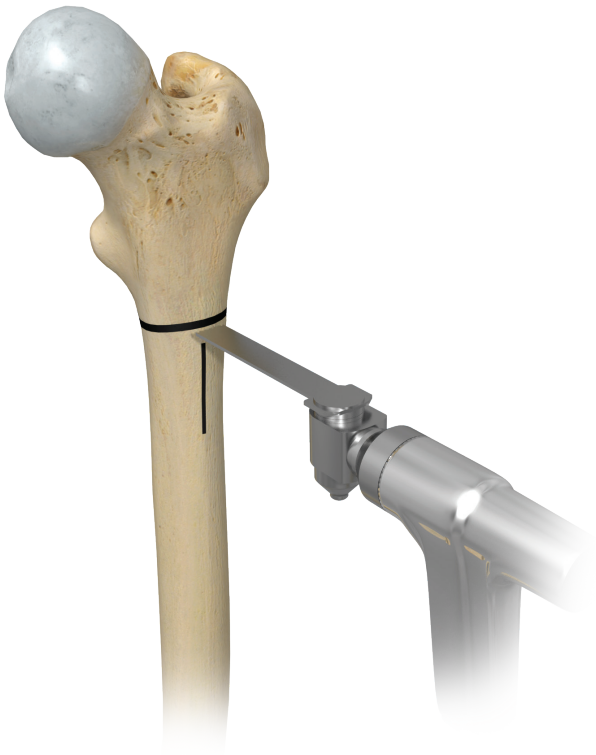

Figure 3



Figure 4

Femoral Osteotomy

Resect the proximal femur at the reference resection mark (Figure 3 and Figure 4).





	Collared Stem or Diaphyseal Segment with Extramedullary Augment and Non-Collared Stem	Segmental Adapter with Non-Collared Stem	Diaphyseal Segment with Intramedullary Augment and Non-Collared Stem	Collared Splined Stem
				
Flexible Ream Depth	Stem Length	Stem Length + 30 mm	Stem Length + Augment Depth	Stem Length
Flare Ream Depth	Flare to Etch	Flare to Flat	Flare to Flat	n/a
Plane the Resection	Planer	Planer	Planer and Augment Reamer	Splined Reamer

Chart 2: Proximal Femoral Canal Preparation Options

Canal Preparation

There are four options for preparing the proximal femoral canal for a proximal femoral replacement. Before flexible reaming, reference Chart 2 to determine the appropriate option for preparing the femoral canal.



Figure 5



Figure 5a

Flexible Reaming

Start at full power prior to contact and progressively ream in .5 mm increments using the flexible reamers to the appropriate laser-etched markings until cortical chatter is obtained (Figure 5 and Figure 5a).

Note: For bowed stems, final flexible reamer diameter may need to be larger than definitive trial and implant diameter (Reamer/Trial/Stem Diameter Example).

Note: Reaming over a guide is recommended. The Arcos Flexible Reamers that are designed to prepare for a bowed stem are cannulated to accommodate a guide wire.

If preparing the canal for a collared splined stem proceed to page 16.

Reamer/Trial/Stem Diameter Example	
Flexible Reamer	11 mm
Trial Stem	11 mm
Splined Stem (implant)	11 mm
Porous Stem (implant)	11.5 mm
Cemented Stem (implant)	9 mm





Figure 6



Figure 7a



Figure 7b

Flare Reaming

Based on the diameter of the final flexible reamer, select the flare reamer of equivalent size and ream the canal opening (Figure 6).

To prepare the canal for a collared stem or a diaphyseal segment with an extramedullary augment with a non-collared stem, start at full power prior to contact and ream to the etch mark on the flutes (Figure 7a). To prepare the canal for a segmental adapter with a stem or a diaphyseal segment with and intramedullary augment and a stem, start at full power prior to contact and ream the flare to the flat (Figure 7b).

Note: When trialing, select the stem trial corresponding to the last flare reamer used.

Flare Reamer
Reamers Tray 3





Figure 8

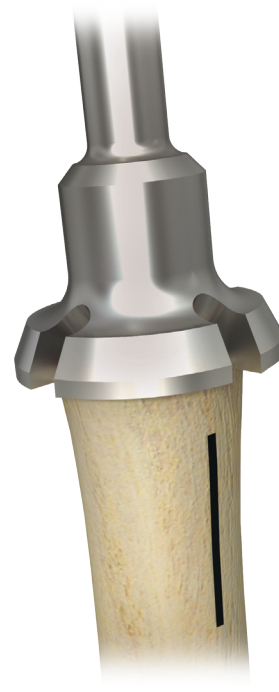

Figure 9

Resection Planing

Place the resection planer over the shaft of the flare reamer (Figure 8).

Start at full power prior to contact and plane the resected proximal femur (Figure 9).

Resection Planer 110018812
Reamers Tray 3



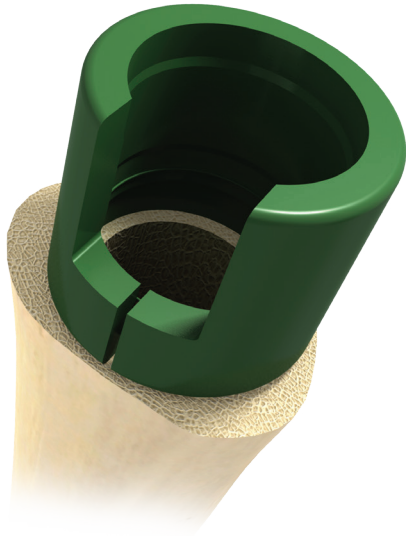

Figure 10

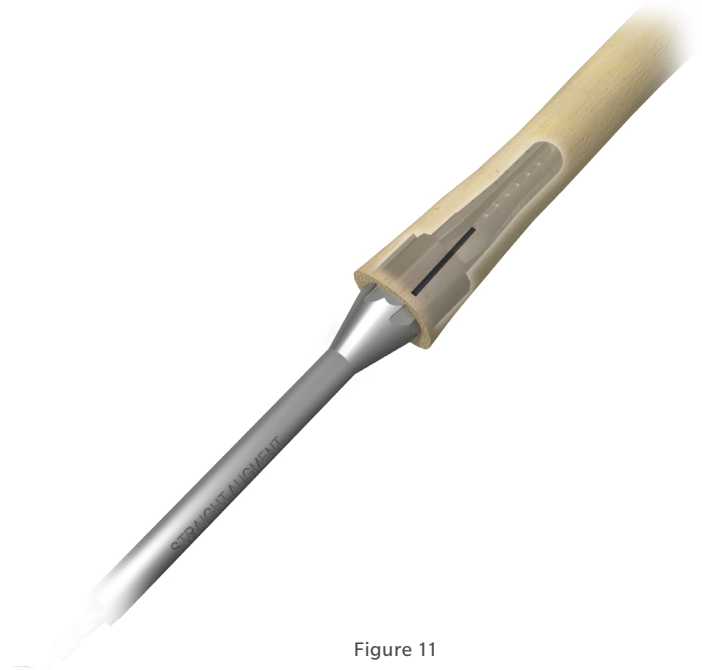

Figure 11

IM Diaphyseal Augment Preparation (optional)

Diaphyseal augments may be placed intra or extramedullary, at the level of the osteotomy. To prepare for intramedullary placement, select augment size and type, based on defect or bone void (Figure 10).

Select the corresponding size augment reamer. Insert the augment reamer over the flare reamer. Start power and run at full speed prior to the augment reamer contacting the bone. Ream to mechanical stop (Figure 11).

Warning #1: Do not utilize more than one diaphyseal augment per individual diaphyseal segment.

Warning #2: Diaphyseal augments can only be utilized with the following segments which have a corresponding external taper (151836, 151837, 151838, 151839, 151840, 151841, 150842, 151843, 151844, 151845, 151846, and 151847).

Augment Trials
STND Segmental Provisionals Tray 5



Augment Reamers
STND Segmental Provisionals Tray 5
Femoral Bone Prep Tray 1



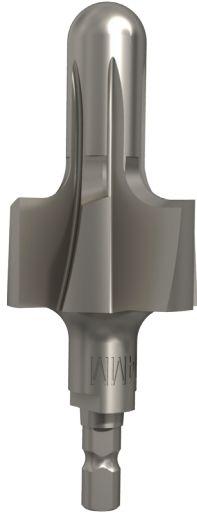

Figure 12

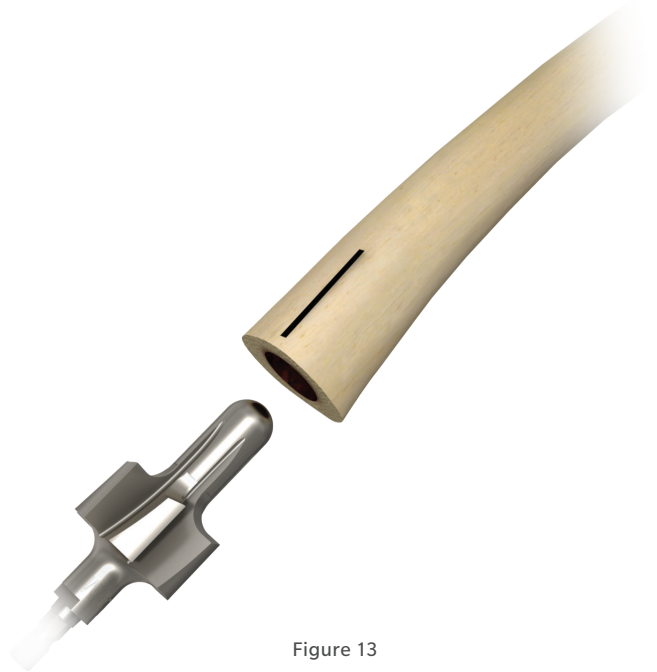

Figure 13

Collared Splined Stem Bone Preparation

Select the collared splined stem reamer with integrated planer that corresponds to the final flexible reamer diameter (Figure 12).

Start full power prior to contacting bone. Ream to full circumferential contact (Figure 13). Proceed to page 21 for trialing.



Trialing – Proximal Femur

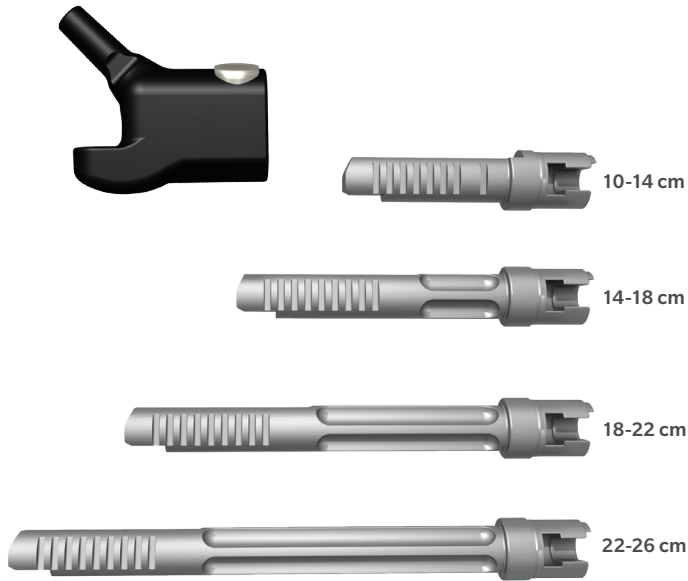

Figure 14



Figure 15



Figure 15a

Proximal Femoral Replacement Utilizing Expandable Trials

Note: For a 7 cm replacement, proceed to page 24.

Based on the resection length of the proximal femur, select the diaphyseal segment trial to be used with the 7 cm expandable proximal femoral trial.

There are four expandable segment trials marked to match the resection length of the proximal femur (Figure 14).

Note: See Proximal Femoral Resection Chart 1 on page 11 for available construct lengths.

Note: All proximal femoral trials and implants have 15 degrees of anteversion built into the design.

Connect the collared stem trial into the selected diaphyseal trial (Figure 15).

If a non-collared stem is chosen, attach the trial diaphyseal augment to the segment trial and connect to stem trial (Figure 15a).

Expandable Segmental Trial
STND Segmental Provisionals Tray 5



Augment Trials
STND Segmental Provisionals Tray 5



Stem Trials
Short Provisional Stems Tray 7
Long Provisional Stems Tray 8



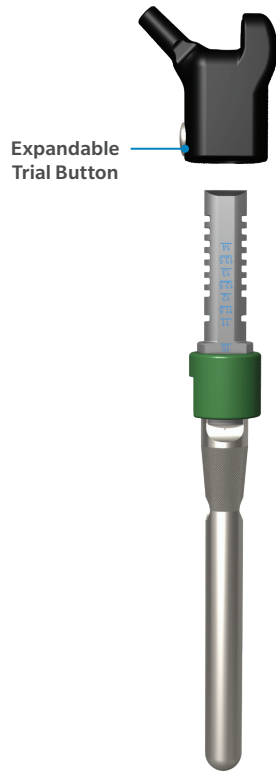

Figure 16

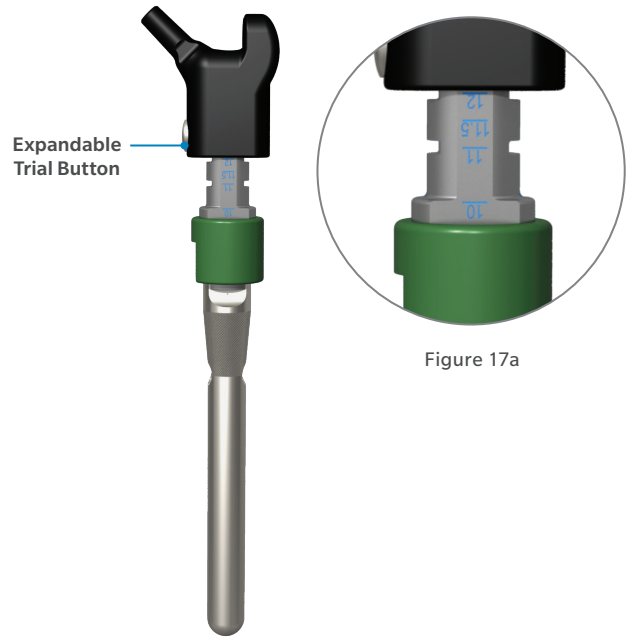

Figure 17a

Figure 17

Proximal Femoral Replacement Utilizing Expandable Trials (cont.)

Insert the expandable construct trial into the expandable proximal femoral trial by pressing the expandable trial button (Figure 16).

Expand trial to corresponding resection length (Figure 17).

Note: Markings on expandable segments indicate total resection length (Figure 17a).





Figure 18



Figure 19



Figure 20a



Figure 20b

Proximal Femoral Replacement Utilizing Quick Connect Trials

To trial for a proximal femoral component used directly with a stem trial, attach the stem trial to the 7 cm elliptical proximal femoral trial (Figure 18) or a collared stem trial to a 7 cm proximal femoral trial (Figure 19).

Note: The collar of the stem will add 1 cm to the proximal femoral construct length.

Note: All proximal femoral trials and implants have 15 degrees of anteversion built into the design.

The low profile proximal femoral trial can be used in conjunction with the augment trials or the greater trochanteric augment trial. To use, snap the selected augment trial onto the low profile proximal femoral trial (Figure 20a and Figure 20b).

Finn Proximal Femoral Trials
Proximal/Total Femoral Tray 15



Stem Trials
Short Provisional Stems Tray 7
Long Provisional Stems Tray 8



Proximal Femoral Impactor
110024553
General Instruments Tray 12



Low Profile Femoral Trial
Proximal/Total Femoral Tray 15



Modular Greater Troch Trial
110018664
Proximal/Total Femoral Tray 15



Augment Trials
STND Segmental Provisionals Tray 5





Figure 21



Figure 22



Figure 23

To use a proximal femoral trial with a quick connect segment, select the quick connect segment trial based on the level of resection. Attach the augment trial to the quick connect segment trial (Figure 21) and connect to selected stem trial (Figure 22).

Attach the proximal femoral trial to the segment trial (Figure 23).

Quick Connect Diaphyseal Segment Trials
Proximal/Total Femoral Tray 15



Augment Trials
STND Segmental Provisionals Tray 5



Stem Trials
Short Provisional Stems Tray 7
Long Provisional Stems Tray 8





Figure 24



Figure 25



Figure 26



Figure 27

Proximal Femoral Replacement Utilizing Quick Connect Trials (cont.)

Assemble the proximal femoral impactor by inserting the post into the proximal femoral handle (Figure 24). After the post is inserted, the visible marking on the post should match the proximal femoral component being utilized. Slide the inserter fork over the post and snap onto the handle (Figure 25 and Figure 26).

Select a legacy Biomet femoral head (Type 1 Taper) and appropriate acetabular provisionals to complete trialing.

Insert the trial assembly into the femoral canal using the proximal femoral impactor (Figure 27) taking care to align the anterior witness mark on the stem trial with the anterior mark previously made on the proximal femur.

Finn Proximal Femoral Trials
Proximal/Total Femoral Tray 15



Proximal Femoral Impactor 110024553
General Instruments Tray 12





Figure 28



Figure 29



Figure 30

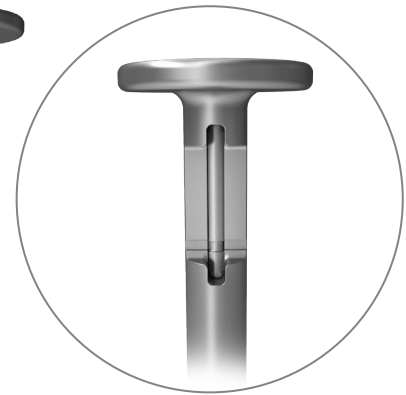

Figure 30a

Trial Removal

If the proximal femoral trial is difficult to remove by hand, begin by separating the proximal femoral/segment and augment construct trial from the stem trial. Insert the stem trial extractor onto the stem trial (Figure 28).

Align the anterior witness marks and turn clockwise. Insert the stem trial extractor rod to prevent the stem trial from separating from the stem trial extractor (Figure 29, 30 and 30a).

Thread the slide hammer into the stem trial extractor to remove.

Stem Trial Extractor 110024532
General Instruments Tray 14



Slide Hammer 31-473621
General Instruments Tray 14



Implant Assembly – Proximal Femur





	Small Head / Small Thread Locking Screw	Large Head / Small Thread Locking Screw	Large Head / Large Thread Locking Screw	Stacking Adapter
				
Packaged with	Low Profile Proximal Femur	Stem	Segments	Packaged Separately

Chart 3: Locking Screw Chart

Implant Assembly Screw Packaging Information

Before assembling the implants, it is important to note which locking screws are used and how they are packaged. Depending on the type of construct assembled, some screws may or may not be used.

Diaphyseal segments and Low Profile Proximal Femurs are packaged with a small head/small thread locking screw and a large head/large thread locking screw.

Stems are packaged with a large head/small thread locking screw.

Stacking adapter is packaged separately.

Finn/Letson™ Proximal Femur Implant Assembly

Implant Assembly without Augments and Segments

Reference page 26 for proximal femoral impactor assembly.

To impact the proximal femoral component with a stem, assemble the stem impactor onto the impaction base. Vigorously impact using the proximal femoral impactor (A).

After impaction, secure the construct with the large head/small thread locking screw packaged with the stem through the proximal femoral component (B) with a 3.5 mm driver.

The proximal femoral component is now implanted using contemporary techniques. Select a legacy Biomet femoral head (Type 1 Taper) and appropriate acetabular components to complete implantation.

Note: All proximal femoral implants have 15 degrees of anteversion built into the design.

Note: If assembling a Low Profile proximal femoral component, refer to page 39.

Cementing the Proximal Femur

If cementing the stem, insert a cement plug then retrograde fill the canal and pressurize. Carefully clean out any excess cement using a curette or similar instrument.

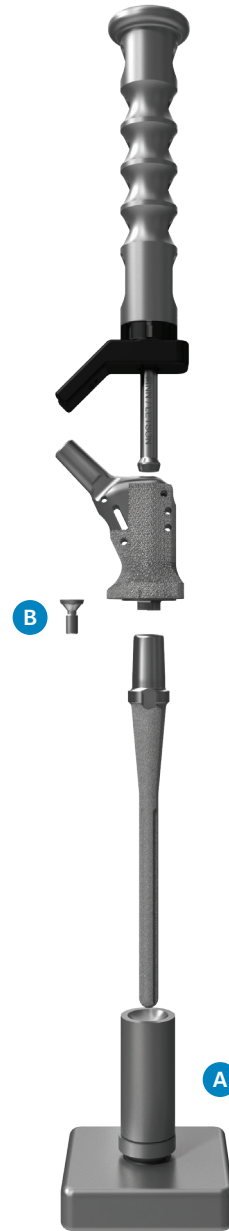

Figure 31

Stem Impactor
General Instruments Tray 12



Impaction Base
General Instruments Tray 12



3.5 mm Driver (Long or Short)
General Instruments Tray 13



Proximal Femoral Impactor 110024553
General Instruments Tray 12



Implant Assembly with Augments and Segments

Step 1: Augment Assembly

To impact the diaphyseal segment with an augment, insert the taper sleeve into the diaphyseal impactor and thread onto the impaction handle (A). Thread the augment impactor onto the impaction base (B). Vigorously impact using the impaction handle (Figure 32).

Warning #1: Do not utilize more than one diaphyseal augment per individual diaphyseal segment.

Warning #2: Diaphyseal augments can only be utilized with the following segments which have a corresponding external taper (151836, 151837, 151838, 151839, 151840, 151841, 150842, 151843, 151844, 151845, 151846, and 151847).



Figure 32

Taper Sleeve
General Instruments Tray 12



Diaphyseal Impactor
General Instruments Tray 12



Impaction Handle
General Instruments Tray 12



Augment Impactor
General Instruments Tray 12



Impaction Base
General Instruments Tray 12



Implant Assembly with Augments and Segments (cont.)

Step 2: Stem Assembly

To impact the diaphyseal segment with a stem, remove augment impactor and thread the stem impactor onto the impaction base (B). Vigorously impact using the assembled impaction handle.

Make certain to locate and discard the large head/small thread locking screw packaged with the stem as it will not be used.

After impaction, secure the construct with the small head/small thread locking screw packaged with the segment through the diaphyseal segment (C) with the 3.5 mm driver (Figure 33).

Do not discard the large head/large thread locking screw packaged with the segment if directly impacting the segment/stem construct to a Finn/Letson Proximal femoral component as it is needed to secure the final construct.

Discard the large head/large thread locking screw packaged with the segment if stacking a second diaphyseal segment to the segment/stem construct (Step 3).



Figure 33

Taper Sleeve
General Instruments Tray 12



Diaphyseal Impactor
General Instruments Tray 12



Impaction Handle
General Instruments Tray 12



Impaction Base
General Instruments Tray 12



3.5 mm Driver (Long or Short)
General Instruments Tray 13



Implant Assembly with Augments and Segments (cont.)

Step 3: Stacking a Second Segment

If not utilizing a second diaphyseal segment, proceed to Step 4: Proximal Femoral Assembly.

BEFORE impacting a second diaphyseal segment, thread the stacking adapter into the male taper of the diaphyseal segment/stem construct with the axle driver (A). The stacking adapter is packaged separately.

To impact the diaphyseal segment with the diaphyseal segment/stem construct, use the assembled impaction base (B). Vigorously impact using the assembled impaction handle.

After the second diaphyseal segment is impacted with the diaphyseal segment/stem construct, secure with the small head/small thread locking screw through the diaphyseal segment (D) with a 3.5 mm driver. Screw is packaged with the second diaphyseal segment (Figure 34).

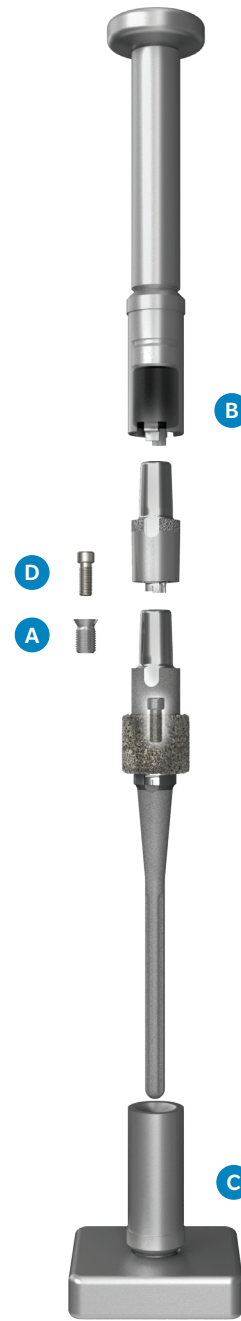

Figure 34

Taper Sleeve
General Instruments Tray 12



Diaphyseal Impactor
General Instruments Tray 12



Impaction Handle
General Instruments Tray 12



Stem Impactor
General Instruments Tray 12



Impaction Base
General Instruments Tray 12



3.5 mm Driver (Long or Short)
General Instruments Tray 13



Axle Driver CP461009
General Instruments Tray 13



Implant Assembly with Augments and Segments (cont.)

Step 4: Proximal Femoral Assembly

Reference page 26 for proximal femoral impactor assembly.

To impact the proximal femoral component with the stem construct, use the assembled impaction base (A). Vigorously impact using the proximal femoral impactor.

After the proximal femoral component has been impacted with the stem construct, insert the large head/large thread locking screw packaged with the segment, through the proximal femoral component and tighten with a 3.5 mm driver (B).

Note: All proximal femoral implants have 15 degrees anteversion built into the design.

The proximal femoral component is now implanted using the proximal femoral impactor and contemporary techniques. Select a legacy Biomet femoral head (Type 1 Taper) and appropriate acetabular components to complete implantation.

Cementing the Proximal Femur

If cementing the stem, insert a cement plug then retrograde fill the canal and pressurize. Carefully clean out any excess cement using a curette or similar instrument.

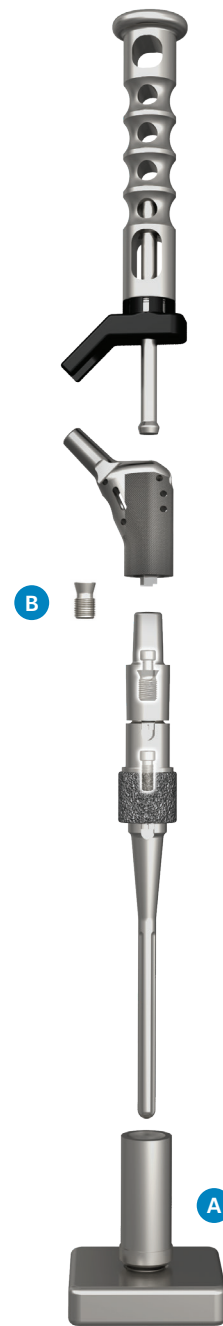

Figure 35

3.5 mm Driver (Long or Short)
General Instruments Tray 13



Proximal Femoral Impactor 110024553
General Instruments Tray 12



Stem Impactor
General Instruments Tray 12



Impaction Base
General Instruments Tray 12





Figure 36



Figure 37

Utilizing a Soft Tissue Claw

Both the OSS Finn and Letson-style proximal femoral implants will accept the oblong trochanteric bolt and soft tissue claw used with the Mallory-Head® calcar hip (Figure 36 and Figure 37).

- Note:** To prepare the proximal femoral implants with the oblong trochanteric bolt and soft tissue claw, reference the Mallory-Head Modular Calcar Surgical Technique.

Low Profile Proximal Femur Implant Assembly

Implant Assembly with Augments and Segments

Step 1: Augment Assembly

Augment to Segment: To impact the diaphyseal segment with an augment, thread the augment impactor onto the impaction base (B). Insert the taper sleeve into the diaphyseal impactor and thread onto the impaction handle (A). Vigorously impact using the impaction handle (Figure 38).

Augment to Proximal Femur: Reference page 26 for proximal femoral impactor assembly.

To impact the proximal femoral component with the greater trochanter, thread the augment impactor onto the impaction base (A). Vigorously impact with the proximal femoral impactor (Figure 39).

If impacting directly to a stem, proceed to Step 2, Option 2.



Figure 38

Figure 39

Taper Sleeve
General Instruments Tray 12



Diaphyseal Impactor
General Instruments Tray 12



Impaction Handle
General Instruments Tray 12



Augment Impactor
General Instruments Tray 12



Impaction Base
General Instruments Tray 12



Proximal Femoral Impactor 110024553
General Instruments Tray 12



Implant Assembly with Augments and Segments (cont.)

Step 2: Stem Assembly

Option 1 Segment to Stem: To impact the diaphyseal component with a stem, remove the augment impactor and thread the stem impactor onto the the impaction base (B). Vigorously impact using the assembled impaction handle.

Secure the construct with the small head/small thread locking screw packaged with the segment and secure with the 3.5 mm driver (C) (Figure 40).

Option 2 Proximal Femur to Stem: Reference page 26 for proximal femoral impactor assembly.

Thread the stem impactor onto the impaction base and align the proximal femoral construct with the stem (A). Vigorously impact the taper with the proximal femoral impactor.

Secure the construct with the small head/small thread locking screw packaged with the segment using the 3.5 mm driver (B) (Figure 41).

The proximal femoral construct is now implanted using contemporary techniques.

Select a legacy Biomet femoral head (Type 1 Taper) and appropriate acetabular provisionals to complete implant assembly.

Continue to page 42 for optional Bolt and Spiked Washer Assembly.

Cementing the Proximal Femur

If cementing the stem, insert a cement plug then retrograde fill the canal and pressurize. Carefully clean out any excess cement using a curette or similar instrument.

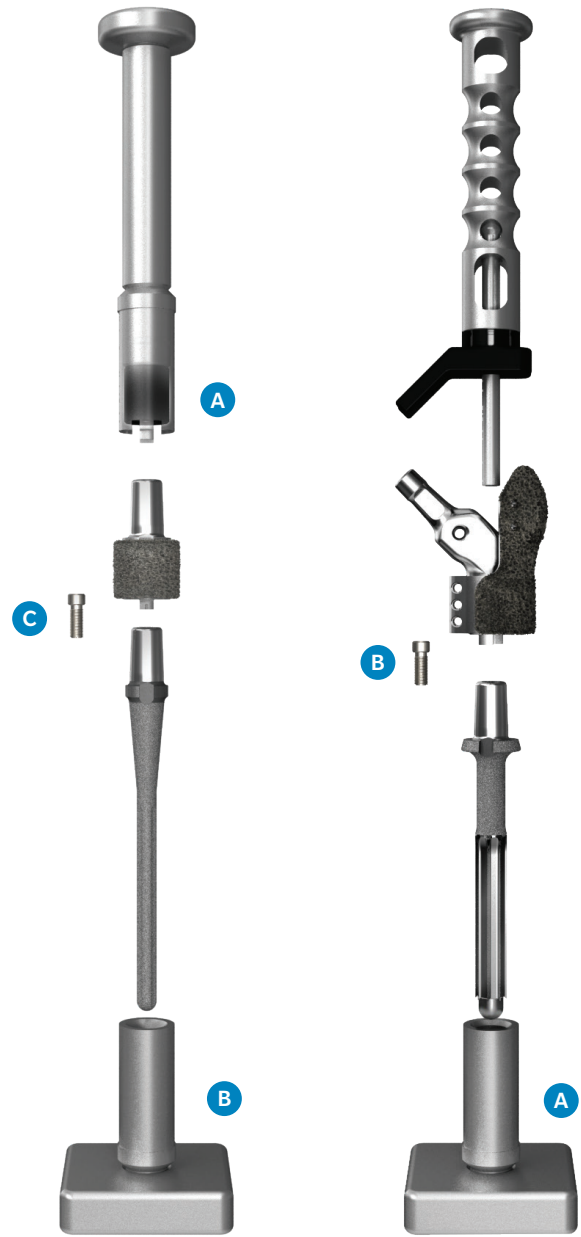

Figure 40

Figure 41

Taper Sleeve
General Instruments Tray 12



Diaphyseal Impactor
General Instruments Tray 12



Impaction Handle
General Instruments Tray 12



Stem Impactor
General Instruments Tray 12



Impaction Base
General Instruments Tray 12



3.5 mm Driver (Long or Short)
General Instruments Tray 13



Proximal Femoral Impactor 110024553
General Instruments Tray 12



Implant Assembly with Augments and Segments (cont.)

Step 3: Stacking a Second Segment

If not utilizing a second diaphyseal segment, proceed to Step 4: Proximal Femoral Assembly.

BEFORE impacting the second diaphyseal segment, thread the stacking adapter into the diaphyseal segment/stem construct using the axle driver (A).

The stacking adapter is packaged separately.

To impact the diaphyseal segment with the diaphyseal segment/stem construct, use the assembled impaction base (B). Vigorously impact using the assembled impaction handle (C).

After the second diaphyseal segment is impacted with the segment/stem construct, secure with the small head/small thread locking screw through the segment with the 3.5 mm locking screw (D). The screw is packaged with the second segment (Figure 42).

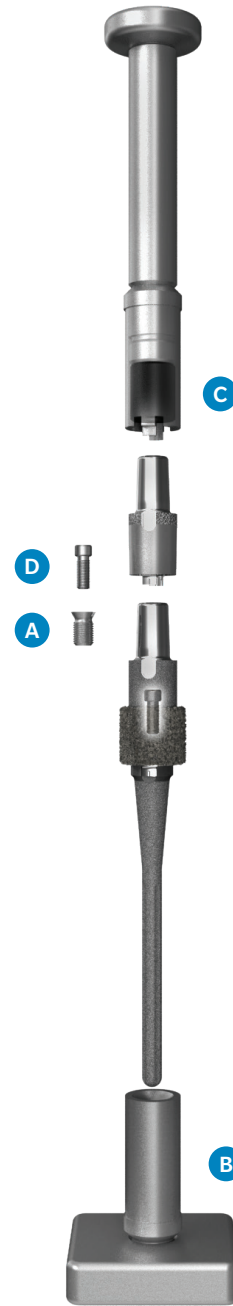

Figure 42

Axle Driver CP461009
General Instruments Tray 13



Stem Impactor
General Instruments Tray 12



Impaction Base
General Instruments Tray 12



Diaphyseal Impactor
General Instruments Tray 12



Taper Sleeve
General Instruments Tray 12



Impaction Handle
General Instruments Tray 12



3.5 mm Driver (Long or Short)
General Instruments Tray 13



Implant Assembly with Augments and Segments (cont.)

Step 4: Proximal Femoral Assembly

BEFORE impacting the proximal femoral component to the construct assembly, thread the stacking adapter into the diaphyseal segment/stem construct using the axle driver (A).

The stacking adapter is packaged separately.

To impact the proximal femoral component with the stem construct, thread the stem impactor onto the impaction base (B). Vigorously impact using the proximal femoral impactor.

Secure the construct with the small head/small thread locking screw packaged with the proximal body through the proximal femoral component with the 3.5 mm driver (C) (Figure 43).

Note: The low profile implants have 15 degrees of anterversion built into the design.

The proximal femoral construct is now implanted using contemporary techniques.

Select a legacy Biomet femoral head (Type 1 Taper) and appropriate acetabular provisionals to complete implant assembly.

Continue to page 42 for optional Bolt and Spiked Washer Assembly.

Cementing the Proximal Femur

If cementing the stem, insert a cement plug then retrograde fill the canal and pressurize. Carefully clean out any excess cement using a curette or similar instrument.

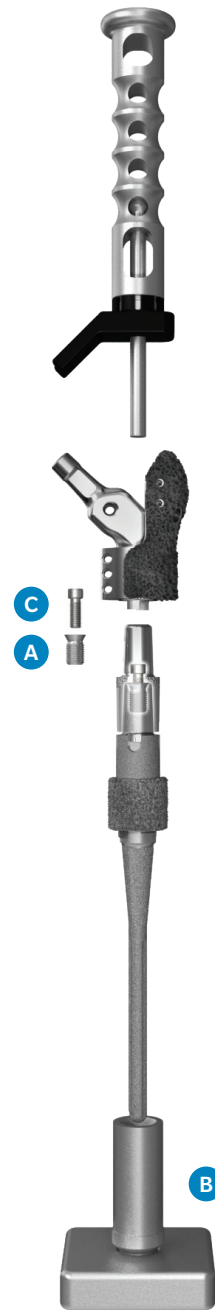

Figure 43

Stem Impactor
General Instruments Tray 12



Impaction Base
General Instruments Tray 12



Proximal Femoral Impactor 110024553
General Instruments Tray 12



3.5 mm Driver (Long or Short)
General Instruments Tray 13



Implant Assembly without Augments and Segments

Step 1: Stem Assembly

Reference page 26 for proximal femoral impactor assembly.

Thread the stem impactor onto the impaction base (A) and align the proximal component to the stem. Vigorously impact the taper utilizing the proximal femoral impactor.

Secure the construct with the small head/small thread locking screw packaged with the proximal body and secure with the 3.5 mm driver (B) (Figure 44).

Note: The low profile implants have 15 degrees of anteversion built into the design.

The proximal femoral construct is now implanted using contemporary techniques.

Select a legacy Biomet femoral head (Type 1 Taper) and appropriate acetabular provisionals to complete implant assembly.

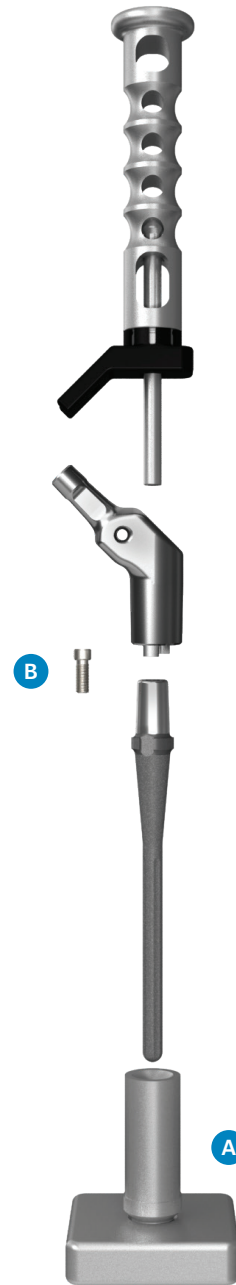

Figure 44

Stem Impactor
General Instruments Tray 12



Impaction Base
General Instruments Tray 12



Proximal Femoral Impactor 110024553
General Instruments Tray 12



3.5 mm Driver (Long or Short)
General Instruments Tray 13





Figure 45



Figure 46

Bolts and Spiked Washer Assembly for OsseoTi Greater Trochanteric Augment (optional)

ⓘ **Note:** For the proximal femur, the spiked washers and bolts are only compatible with the OsseoTi greater trochanteric augment.

Secure the gluteus medius over the horn of the greater trochanter (Figure 45).

To prepare for spiked washers and bolts, use a surgical marking pen to mark the location of the bolt holes of the greater trochanter on the gluteus medius (Figure 46).

Once the gluteus medius has been marked, pull back the tendon and drill holes on the markings using the bolt drill.

ⓘ **Note:** It is important that the bolt drill does not come in contact with the greater trochanter when drilling to protect the trochanter from damage.

Bolt Drill 110018811
General Instruments Tray 12



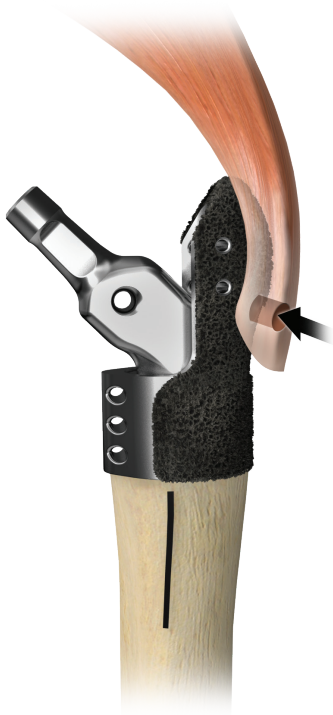

Figure 47

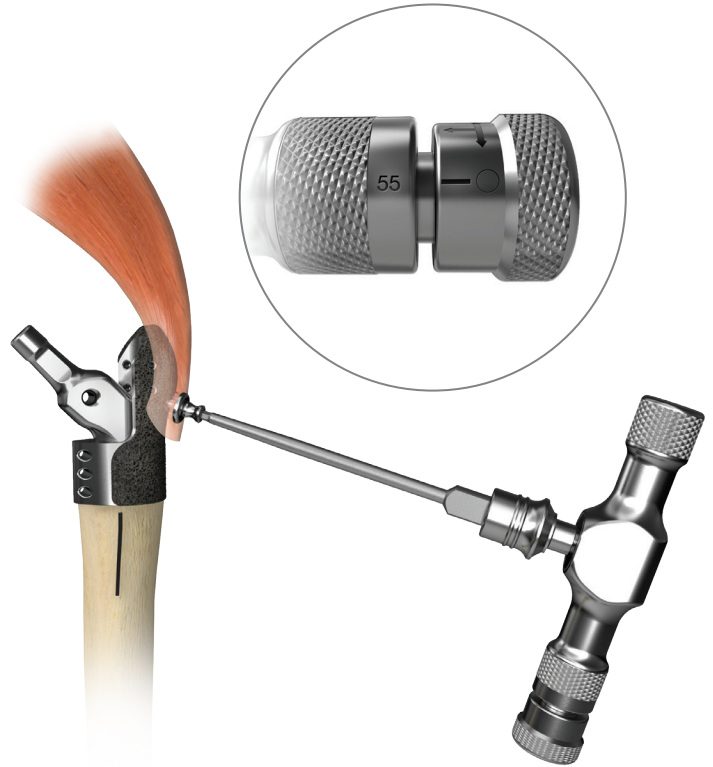

Figure 48

Bolts and Spiked Washer Assembly for OsseoTi Greater Trochanteric Augment (optional) (cont.)

Measure the thickness of the gluteus medius at the location of the hole. Select the corresponding bolt size based on the tendon thickness (Figure 47).

For example, if the gluteus medius measures 10 mm thick, select the 10 mm spiked washer bolt.

Thread the bolt and spiked washer into the greater troch using the 3.5 mm hex driver and the torque wrench in the torque limiting position of “55” until a “click” is felt and heard (Figure 48).

Torque Wrench 31-301850
General Instruments Tray 13

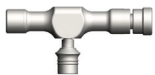

3.5 mm Hex Driver 405898
General Instruments Tray 13





Figure 49



Figure 50

Bolts and Spiked Washer Assembly for OsseoTi Greater Trochanteric Augment (optional) (cont.)

Using the thread stake, locate the holes on the lateral and medial sides of the OsseoTi greater trochanteric augment (Figure 49).

Impact the thread stake into the holes to deform the bolt threads in order to prevent the washer and bolt from loosening (Figure 50).

Sutures are optional and may be used for securing soft tissue.

Thread Stake 110018810
General Instruments Tray 12



Trialing – Total Femur



Figure 51



Figure 52

Trialing: Total Femoral

Measure the length of the entire femur to determine the total femur construct length. Connect the 7 cm proximal femoral trial to the 10 cm or 30 cm total femoral coupler (Figure 51).

Connect the selected expandable segment trial to the distal end (Figure 52).

Finn Proximal Femoral Replacement
Proximal/Total Femoral Tray 15



Low Profile Femoral Trial
Proximal/Total Femoral Tray 15



Total Femoral Coupler
Proximal/Total Femoral Tray 15



Expandable Diaphyseal Trials
STND Segmental Provisionals Tray 5





Figure 53

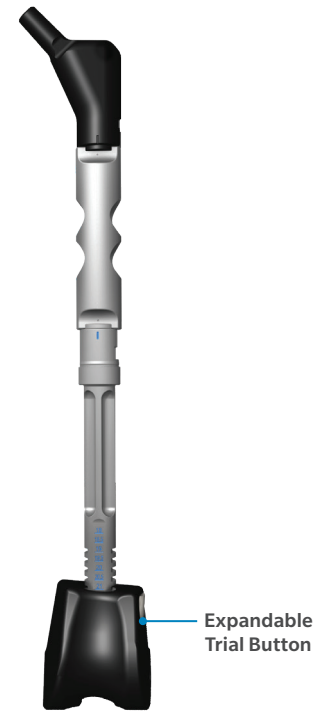

Figure 54

Insert into the expandable distal femoral trial by pressing the expandable button (Figure 53). Expand to the corresponding length of the entire femur (Figure 54).

Example shows 39 cm of replacement length consisting of:

- 7 cm proximal femoral replacement
- 10 cm total femoral coupler replacement
- 15 cm of diaphyseal replacement*
- 7 cm of segmental distal femoral replacement*

* Combined lengths are represented as 21 cm on the expandable shaft

ⓘ **Note:** To prepare the tibia, reference the Distal Femoral Replacement Surgical Technique, the Segmental Distal Femoral Surgical Technique, or the Proximal Tibial Replacement Surgical Technique.

ⓘ **Note:** The patella is prepared using a legacy Biomet patella of choice. It is not recommended to use a patella smaller than 31 mm.

Expandable Femoral Trial
STND Segmental Provisionals Tray 5
RS Femoral Provisionals Tray 6



Expandable Trial Button 110018632
STND Segmental Provisionals Tray 5



Implant Assembly – Total Femur





	Small Head / Small Thread Locking Screw	Large Head / Small Thread Locking Screw	Large Head / Large Thread Locking Screw	Stacking Adapter
				
Packaged with	Low Profile Proximal Femur	Coupler (2)	Segments	Packaged Separately

Chart 3: Locking Screw Chart

Implant Assembly Screw Packaging Information

Before assembling the implants together, it is important to note which screws are used and how they are packaged. Depending on the type of construct assembled, some screws may or may not be utilized.

Diaphyseal segments are packaged with both a small head/small thread locking screw and a large head/large thread locking screw.

Total femoral couplers are packaged with two large head/small thread locking screws.

The stacking adapter is packaged separately.

Implant Assembly

Step 1: Coupler Assembly

Reference page 37 if using an augment with the low profile proximal femur or segment.

Reference page 26 for proximal femoral impactor assembly.

To impact the proximal femoral component with the coupler, insert the taper sleeve into the diaphyseal impactor and thread onto the impaction base (A). Align the proximal femoral construct with the femoral coupler and vigorously impact the tapers with the proximal femoral impactor (Figure 55).

Do NOT discard the two large head/small thread locking screws packaged with the coupler. If connecting a total femoral coupler directly to a proximal femur and a segmental distal femur, use both large head/small thread locking screws.



Figure 55

Taper Sleeve
General Instruments Tray 12



Diaphyseal Impactor
General Instruments Tray 12



Impaction Base
General Instruments Tray 12



Proximal Femoral Impactor 110024553
General Instruments Tray 12



Step 2: Coupler Assembly

If connecting a total femoral coupler directly to a proximal and distal femur, continue to Step 3.

To impact the proximal femoral/coupler construct with a segment, insert the taper sleeve into the diaphyseal impactor and thread onto the impaction base (A). Align the proximal femoral/coupler construct with the segment and vigorously impact the tapers using the proximal femoral impactor (Figure 56).

Do NOT discard the large head/ large thread and small head/small thread locking screws packaged with the segment.



Figure 56

Taper Sleeve
General Instruments Tray 12



Diaphyseal Impactor
General Instruments Tray 12



Impaction Base
General Instruments Tray 12



Proximal Femoral Impactor
110024553
General Instruments Tray 12



3.5 mm Driver (Long or Short)
General Instruments Tray 13



Step 3: Distal Femoral Assembly

Align the segmental distal femoral implant with the diaphyseal segment/femoral coupler/proximal body construct. Vigorously impact the taper with the proximal femoral impactor.

After impaction secure the diaphyseal segment to the femoral coupler with the small head/small thread locking screw (A) using the 3.5 mm long driver. Secure the distal femoral component to the segment/coupler/proximal body construct with a large head/large thread locking screw (B) packaged with the segment using the 3.5 mm driver. Secure the Finn/Letson proximal femur to the construct, with a large head/small thread locking screw (C) packaged with the coupler or secure the low profile proximal femur with a small head/small thread locking screw packaged with the low profile proximal femur using the 3.5 mm driver (Figure 57).

The proximal femoral component is now implanted using contemporary techniques. Select a legacy Biomet femoral head (Type 1 Taper) and appropriate acetabular components to complete implantation.



Figure 57

Proximal Femoral Impactor 110024553
General Instruments Tray 12



3.5 mm Driver (Long or Short)
General Instruments Tray 13



Femoral/Tibial Impactor 110030072
General Instruments Tray 12



All content herein is protected by copyright, trademarks and other intellectual property rights owned by or licensed to Zimmer Biomet or its affiliates unless otherwise indicated and must not be redistributed, duplicated or disclosed, in whole or in part, without the express written consent of Zimmer Biomet.

This material is intended for health care professionals and the Zimmer Biomet sales force. Distribution to any other recipient is prohibited.

For complete product information, including indications for use, contraindications, warnings, precautions and possible adverse effects, see the package insert, and Patient Risk Information at www.zimmerbiomet.com.

Zimmer Biomet does not practice medicine. The treating surgeon is responsible for determining and utilizing the appropriate treatment, techniques, and products for each individual patient.

Check for country product clearances and reference product specific instructions for use.

Not for distribution in France.

©2016 Zimmer Biomet



Authorized Representative

Biomet UK Ltd.
Waterton Industrial Estate
Bridgend, South Wales
CF31 3XA
UK



ZIMMER BIOMET

Your progress. Our promise.™



Legal Manufacturer

Biomet Orthopedics
P.O. Box 587
56 E. Bell Drive
Warsaw, Indiana 46581-0587
USA

www.zimmerbiomet.com

CE 0086

CE mark on a surgical technique is not valid unless there is a CE mark on the product label.