



PERSONA[®] OSSEOTI[®] KEEL TIBIA
PERSONA CEMENTED KEEL TIBIA
PERSONA PPS[®] FEMUR

DESIGN RATIONALE

Total knee replacement has long ranked among the most successful procedures in modern medicine.¹

While excellent implant survivorship has been reported with many of today's knee replacement systems, studies suggest that one in five patients aren't fully satisfied with their new knee.²⁻⁴ Moreover, patients are becoming more demanding and informed, wanting to return to full life with a knee replacement that provides a natural feel and normal function.⁵

To create a natural feel and normal function for patients post-operatively⁶, we believe a system needs to include implants that fit precisely and instruments designed for ease of use.

Persona The Personalized Knee® is our solution featuring personalized implants, precise instrumentation, and proven technology.⁵

While designing the Persona Knee, we used a combination of advanced research tools like the Virtual Biomechanics Knee, ZiBRA™ database, and the KUKA Robot to study hundreds of knees, creating a global bone atlas. This furthered our understanding of native anatomic shape and function which allowed us to better match our implant shapes and sizes to patients of different ethnicity, gender, and stature. In a market focused on matching the bone to the implant shape and size, we found that the opposite needed to happen... we need to match the implant to the resected bone shape and size.

In doing so, we confirmed that implant shape really matters. Fit really matters. Instrumentation and technology really matter.⁷⁻⁸ The Persona Knee was designed with all these elements in mind, because we believe the way to predictably improve patient satisfaction is to more closely reproduce the original. Join us as we explore this personalized approach to restoring the unique identity of every knee.

- **Personalized Implants** designed for optimal fit and function
- **Precise Instrumentation** with personalized control
- **Proven Technology** built on a legacy of clinical performance⁵

REDEFINING PERSONALIZATION

PERSONALIZED IMPLANTS DESIGNED FOR OPTIMAL FIT AND FUNCTION

Implant shape and fit matter in achieving post-operative patient satisfaction.⁷⁻⁸ In designing the Persona Knee, we identified several unmet needs that existed in previous implant designs that we believed, if improved, would help restore a more natural⁶ feeling knee and potentially improve patient satisfaction.

A more anatomically accurate⁷ implant was identified as one of those needs. While symmetric and asymmetric tibial designs had long since served a purpose, we wanted an implant that fit as close to the native tibia as possible. With that, the Persona anatomic tibia was created.

We also believed that the femoral shape should reflect certain characteristics. What was the ethnicity and gender of the patient? Would finer sizing increments help you more closely replace the resected bone?⁹ Could we be more bone conserving?

Combine these enhancements with a full continuum of bearing options, and you'll see how the Persona Knee System is redefining personalization.



UNDERSTANDING THE PROXIMAL TIBIA

ANATOMIC TIBIAL IMPLANTS

In TKA, we see a high variability in the success of setting I/E tibial rotation. The shape of some tibias impose a choice between proper rotation and bone coverage, which can lead to variability in rotational alignment.¹⁰ This is important, because several studies have shown a correlation between mal-rotation and anterior knee pain.⁹⁻¹³ Studies by Martin, *et al.* and Nicoll, *et al.* indicate that internal mal-rotation of implants may lead to over 50 percent of painful TKA cases.^{8,10}

The Persona tibia was designed so you don't need to make this compromise. The anatomic shape is designed to help you achieve both proper rotation and optimal bone coverage.^{7,10} We believe this will help lead to improved knee function and patient satisfaction.

To produce an anatomic tibial tray, understanding the proximal tibia is essential. This includes measurement of the medial and lateral A/P dimensions (A) and reproduction of the anteriomedial and anteriolateral curves (B). This is a key distinction in the Persona anatomic tibia compared to symmetric and asymmetric tibia trays.⁷

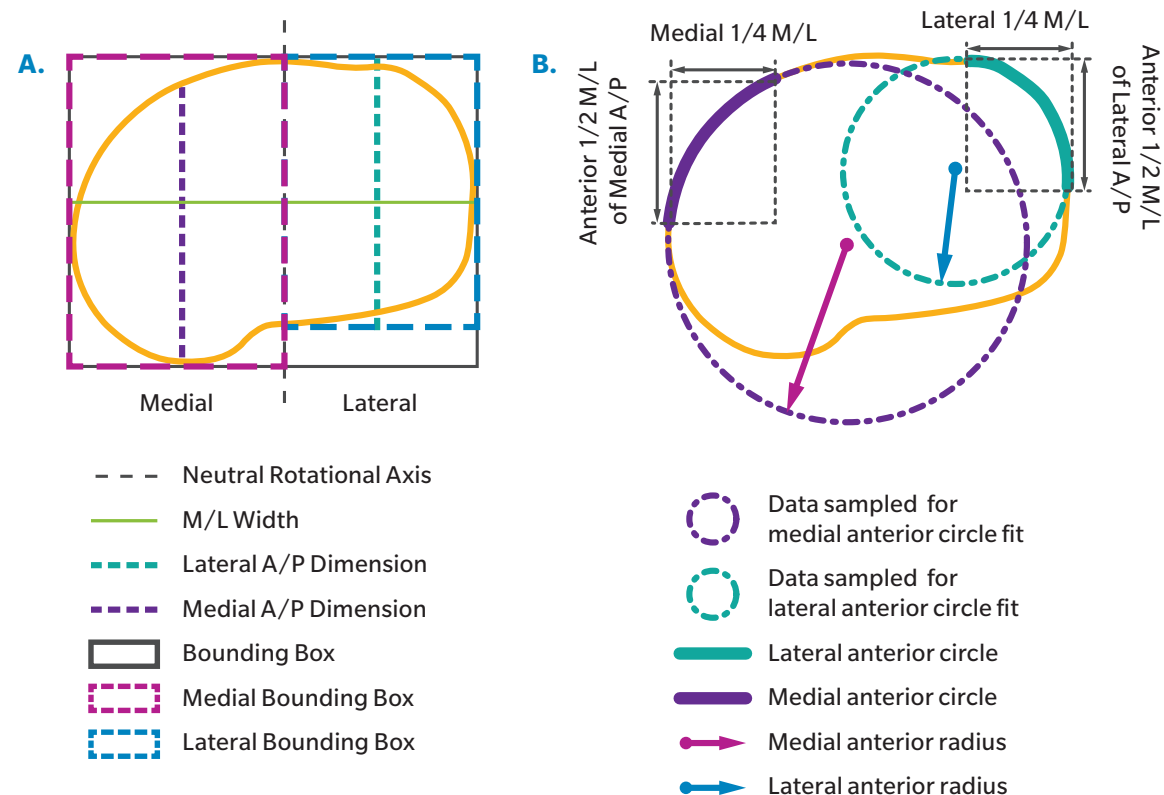

In addition, the Persona tibia was designed by studying the morphology of native tibias of various ethnicities, genders, and sizes. Hundreds of virtual tibial resections were performed and analyzed with varying surgical parameters. This thorough research helped us better understand that variation of the tibial shape was only subtle between ethnicities and gender. Ultimately, we determined that the optimal size and shape of the tibial implant should be anatomic.

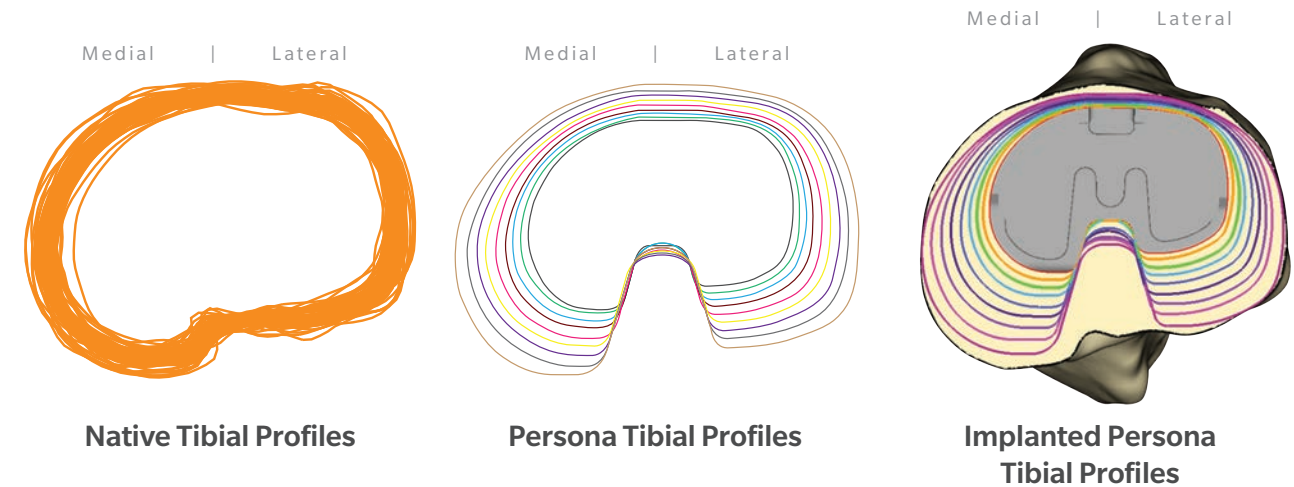

In vitro, the Persona anatomic tibia has demonstrated*:

- 92 percent bone coverage with proper rotation⁷
- Less compromise of coverage (0.5 percent anatomic vs 5 percent non-anatomic)⁷
- Six percent average improvement in coverage compared to non-anatomic designs⁷
- More cortical support⁷
- Lower incidence of downsizing (3 percent anatomic vs 50 percent non-anatomic)⁷
- Persona anatomic tibial tray provides greater stability - less micromotion - than a symmetric tray¹⁷⁻¹⁸

In vivo, the Persona tibia demonstrated:

- A statistically significant decrease in postoperative anterior knee pain and an increase in range of motion.¹⁹
- A statistically significant improvement in medial plateau fit for Asian populations.²⁰
- Ideal rotational alignment in 81.4 percent of patients.²¹

*Laboratory results are not necessarily indicative of clinical performance

Tibial Implant Specs

- Nine anatomic sizes (A-J)
- Anatomic disproportional M/L growth
- Left and right implant options
- Medialized tibial keel designed to place the keel central to the native diaphysis
- Enhanced surface finish designed to aid bearing insertion and minimize backside wear
- Triple wedge design locking mechanism
- No lock-down screws
- No through holes
- Made of Ti-6Al-4V ELI Alloy
- Model for demonstration represents an E sized implant.

PERSONA OSSEOTI KEEL TIBIA: STABLE. VERSATILE. ANATOMIC.

The Persona OsseoTi Keel Tibia is the latest offering within the Persona tibia continuum, representing our next iteration of cementless knee arthroplasty. This tibial implant combines OsseoTi, an additively manufactured porous substrate for biological fixation, with a traditional keel design to provide a unique new offering for our anatomic tibia.

The Persona OsseoTi Keel Tibia blends the history of our legacy knee systems by incorporating a spiked keel design. This design philosophy is aimed to provide **stable initial mechanical fixation**¹⁵ through the progressive press-fit of the keel and pegs across a progressive keel dimension and depth by size. In doing so, we aim to build upon the legacy of our Natural Knee® spikes, innovate upon the clinical heritage of our Vanguard® Knee System's keel design, and couple it with our Persona anatomic tibia to provide better coverage and rotation with less micromotion than symmetric trays.^{18*}



OsseoTi Porous Metal Technology uses human CT data in combination with 3D printing technology to build a structure designed to mimic the architecture of human cancellous bone

The OsseoTi tibia's keel is tapered, providing a progressive press-fit as the implant is inserted, with the overall volume of press-fit based off the clinically successful²²⁻²³ Natural-Knee tibia implants.

- The press-fit of the pegs is based on a 3.2mm (1/8") drill prep for the 4.24mm sq pegs. The peg position is designed to avoid cortical interference via use of the ZiBRA database.
- The peg lengths:
 - 8 mm for A/B/C/D
 - 10 mm for E/F/G/H/J

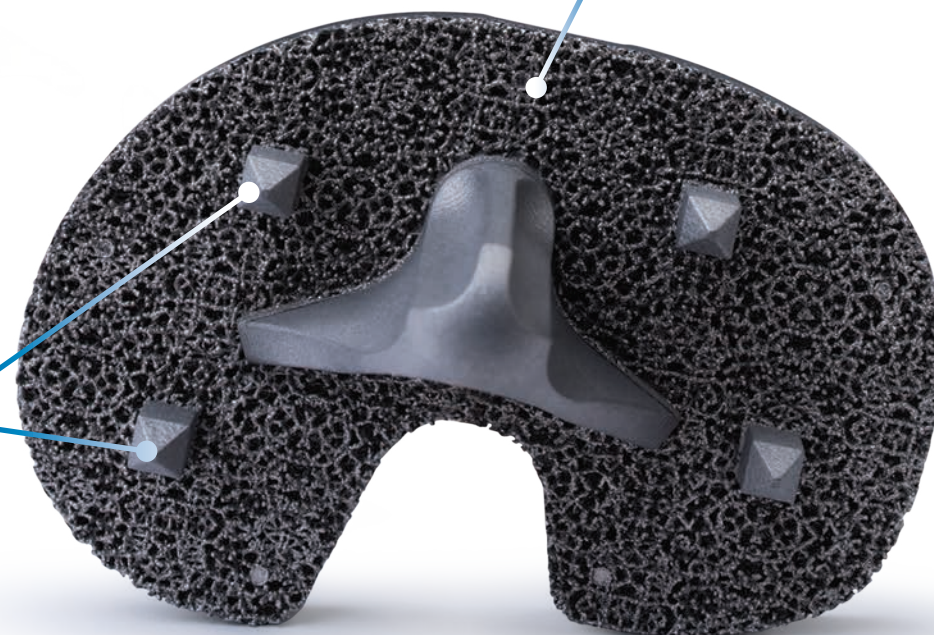

SHOWCASE OF PROGRESSIVE PRESS-FIT

With the OsseoTi keel tibia, the press-fit of the keel increases as it gets closer to the distal surface of the tray, **allowing for up to twice as much press fit as Natural Knee II® based on volume of bone displaced.**¹⁸ This precision tapered keel design is made possible via advanced 3D printing technology, and provides stable initial mechanical fixation to give **confidence** in cementless procedures.¹⁸

Through the personalization and precision of the Persona System, coupled with the familiar keel design based on the successful heritage of previous systems, the Persona OsseoTi Keel Tibia is designed to facilitate surgeon satisfaction. With the additional benefits of cementless procedures, including efficiency, preservation of bone stock, and biologic fixation, this offering facilitates further flexibility and efficiency to your O.R.²⁴

*Laboratory studies are not necessarily indicative of clinical results

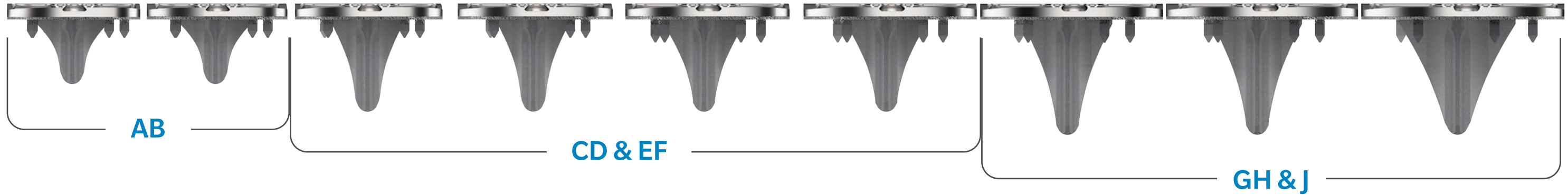

Persona OsseoTi Keel and Cemented Keel Tibia

Tibia Size	AB	CD	EF	GH & J
Keel Length	28 mm	40 mm	40 mm	50 mm
Peg Length	8 mm	8 mm	10 mm	10 mm

Cemented Keel Tibia does not have pegs

The progressive fin and keel design is based on the clinically successful Natural Knee tibia implants, which have a keel that grows proportionally by size.

Persona Keeled Tibial Baseplate Dimensions

Size	Medial A/P (mm)	Lateral A/P (mm)	Overall M/L (mm)
A	40.2	35.1	57.7
B	42.5	37.2	60.8
C	44.9	39.5	63.8
D	47.2	41.8	67.0
E	50.2	44.6	71.0
F	53.3	47.4	75.1
G	56.5	50.2	79.0
H	59.8	53.3	83.0
J	63.5	56.7	88.1

OsseoTi Porous Material

OsseoTi Porous Metal is a material created through the use of a proprietary additive manufacturing process - allowing us to remove the shackles of process limitations to provide a consistent material with a high degree of design flexibility, while being comprised of a highly biocompatible alloy material with excellent corrosion resistance and a strong history of clinical success.²⁵⁻²⁶ This process generates a porous material from a titanium substance with a structure that is designed to mimic the architecture of human cancellous bone to facilitate biological fixation and implant stability.

- Unique porous architecture has demonstrated **excellent integration with host bone as early as 4 weeks in an animal study**^{27*}
- **Porosity** of approximately **70%** directly mimics the structure of **human cancellous bone**²⁷⁻²⁸
- **Average pore size of 475 microns** facilitates cell migration, vascularization, and biological fixation^{27-28*}
- Material strength between that of cancellous and cortical bone **facilitates biological fixation** and loading of surrounding bone^{27*}



4 Weeks early integration with host bone



12 Weeks bone fusion across an 8mm thick sample



26 Weeks extensive biological fixation fills the entire volume of porous sample

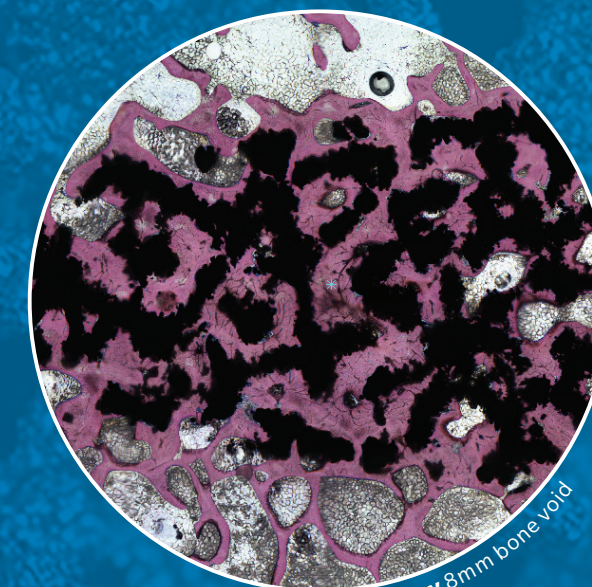

26 Week Histology 8mm bone void

Black: OsseoTi Structure Red: New bone growth White: Void
 *Animal studies are not necessarily indicative of clinical performance.

THE BEST OF BOTH WORLDS

AT YOUR FINGER TIPS

CEMENTED KEEL TIBIA

INTRA-OPERATIVE VERSATILITY

Persona Cemented Keel's four adjunct fixation slots provide for increased cement fixation

Fixation slot dimensions:

- Depth 2.6 mm
- L 5.5-11.3 mm x W 3.5-4.8 mm depending on size
- Undercut depth around slot 0.3 mm

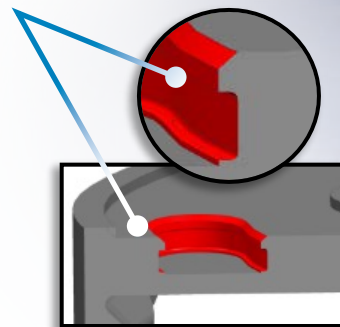

Cement pocket depth of .57 mm

60 grit blast finish designed to aid in fixation consistent with the grit blast finish across the Persona tibia continuum



Persona Cemented Keel Tibia

Zimmer Biomet is proud to offer an even broader portfolio to support cemented procedures. With an ongoing commitment to being a trusted partner in healthcare, we aim to cover the full continuum of treatment options by providing an implant offering featuring the new keel based design while retaining the standard cemented procedure.

This option is the Persona Cemented Keel Tibia, a design that also draws heavily from the Vanguard system's roots, providing a similar feel down to the cement mantle surrounding the fins and enhanced by a tight fit which compresses the implant into the bone to allow for the fixation of cement.

Cemented or Cementless Intra-operative Versatility

Importantly, one of the key features this system will provide is the ability to switch between either a cementless or cemented procedure **intra-operatively** with a single tray, continuing our commitment to providing surgeons with versatility in their O.R.

This decision to proceed with either a **cementless or cemented** procedure can be made up **until the moment of final implantation**, as both procedures utilize the exact **same bone prep** with no need for new instrument preparation to continue forward.

Persona PPS Femur

The latest offering for the Persona family’s femoral implants is the Porous Plasma Spray Femur. The clinically proven²⁹⁻³⁶ PPS coating allows for initial scratch fit stability and biologic fixation through bone ongrowth.

PPS has already shown its capabilities in performance with **95% survivorship at 10 years**.²³ Across multiple applications, the clinical legacy of the PPS material has proven its survivorship for aseptic loosening and has demonstrated increased resistance to micromotion as shown in hip studies.³⁷⁻³⁸

As a new element to our femoral offering, the rails on the implant have been eliminated, allowing for the ability to increase the nominal surface area of porous material on the implants by a minimum of 18% (varying by size) compared to equivalent size of Persona TM femurs.

The PPS femoral implant will still retain the Persona family’s 2 mm** increments in standard and narrow design, providing one of the **most comprehensive femoral sizing options in a single system on the market and allowing you to achieve a personalized femoral fit**. Additionally, this new line of PPS femurs will utilize the existing bone preparation instruments, allowing current Persona users to continue to use their existing resection instrumentation and provisionals.



PPS Femur has a press-fit on average of .3 mm

The elimination of the cast characters on the anterior tip, as well the outer rail removal, allows for at least 18% more porous material when compared to Persona TM Femoral Implants



The PPS material has a nominal thickness of .75 mm

PPS porous technology based on the clinically successful legacy Vanguard PPS porous material technology, allowing for initial scratch-fit stability and biologic fixation²⁹⁻³⁶

Femoral Implant Specs

- Restore soft tissue balance with 12 A/P sizes available in 2 mm* increments that allow for replication of the native A/P dimension.
- Improved femoral fit** with a full offering of standard and narrow implants⁴⁰ is designed to help address the problem of femoral overhang and associated pain that’s observed in 56 percent of TKA patients.⁹
- Enhanced high-flex design safely accommodates high flexion³⁹ while preserving 30 percent more native bone.³⁸
- Anatomic profile and articulation of the Persona Femur supports physiologic internal rotation.

*Size 11 to 12 is a 4 mm increment
**compared to our previous designs

MEDIAL CONGRUENT® BEARING - STABILIZED MOTION



Stabilized Motion

Restores Confidence

The key to achieving a more natural feeling knee is developing implant geometries that function harmoniously with their native kinematics and more closely reproduce the motion⁴¹ and stability they had prior to knee arthritis. When striving to achieve such a goal with an implant design, one of the most difficult obstacles to overcome is achieving maximum stability throughout the full range of motion, and maintaining it while in full extension.

The Medial Congruent

Bearing design prioritizes stability and motion through the concept of stabilized motion. The system's medial conformity and anterior constraint stabilize the knee from full extension through deep flexion. In contrast, the lateral condyle is designed to move freely along an arcuate path to recreate the motion of a healthy knee.

High-Flexion Design: Renews Life

The ability to achieve deep flexion is essential for performing daily activities in many cultures throughout the world. **The dwell points of the Persona Medial Congruent Bearing have been moved posterior to allow surgeons to restore a patient's full range of flexion.**

Persona MC

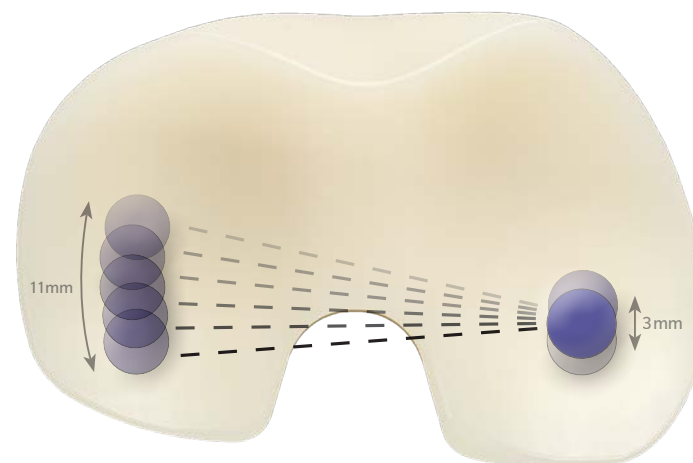

Posterior Dwell Point

A more posterior dwell point accommodates deeper flexion before posterior, femoral bone contacts the posterior lip of a tibial insert.

Medial Congruent Polyethylene Offers Satisfactory Early Outcomes and Patient Satisfaction in Total Knee Arthroplasty⁴²

(Authors: Frye, B., Patton, C., Kinney, J., Murphy, T., Klein, A. and Dietz, M., 2021.)

- Patients with an MC bearing reported significantly higher forgotten joint scores than patients with a CR bearing. This is important because a patient's ability to forget their joint replacement during everyday activities is an important expectation and goal of the surgery, as it reflects patient satisfaction.
- More patients with an MC bearing were "very satisfied" and fewer were "not at all satisfied" compared to patients with a CR bearing
- 92.6% of patients with an MC bearing were "very satisfied" compared to just 81.5% of patients with a CR bearing

Score	Persona MC	Persona CR	Persona PS
FJS at 1 year (95% CI)	71.62 (65.44-77.81)	58.68 (51.9-65.46)	68.71 (64.07- 73.34)
KOOS pain at 1 year (SD)	80.67 (18.29)	76.56 (22.56)	0.047 (22.40)
KOOS ADL at 1 year (SD)	82.01 (17.68)	76.56 (20.02)	86.69 (21.03)
KOOS QoL at 1 year (SD)	60.66 (26.49)	58.62 (22.79)	67.99 (28.29)
KOOS sport at 1 year (SD)	58.53 (33.46)	57.52 (28.95)	65.57 (32.96)
KOOS symptom at 1 year (SD)	80.55 (18.47)	76.05 (18.96)	82.58 (19.87)
PROMIS-10P 1 year (SD)	52.12 (8.75)	51.28 (7.45)	51.08 (8.84)
PROMIS-10M 1 year (SD)	52.12 (7.35)	51.28 (6.37)	51.08 (9.72)

➔ According to the authors, these results indicate that the MC bearing provided similar or improved early pain, ROM, KOOS, PROMIS-10, FJS-12, and patient satisfaction as compared with standard bearings in TKA. Additionally, the MC bearing scored higher in patient satisfaction as compared to CR.

Mid-flexion stability in the anteroposterior plane is achieved with a medial congruent insert in cruciate-retaining total knee arthroplasty for varus osteoarthritis⁴²

- This study has shown that the Persona MC bearing restored physiologic AP kinematics more in mid-flexion than the Persona CR bearing under PCL-retaining conditions.
- Mid-flexion AP stability was greater with the MC bearing than with the CR bearing.
- The results for the CR bearing showed that the femoral position relative to the tibia was significantly anterior at 45°, 60°, and 90° flexion compared to the preoperative condition.
- The authors acknowledged that this paradoxical motion or mid-flexion instability is more common in CR knee designs, and can be one of the causes of dissatisfaction after CR-TKA.
- By comparison the femoral position in the MC group at 45°, 60°, and 90° flexion did not differ significantly from that of the preoperative condition.

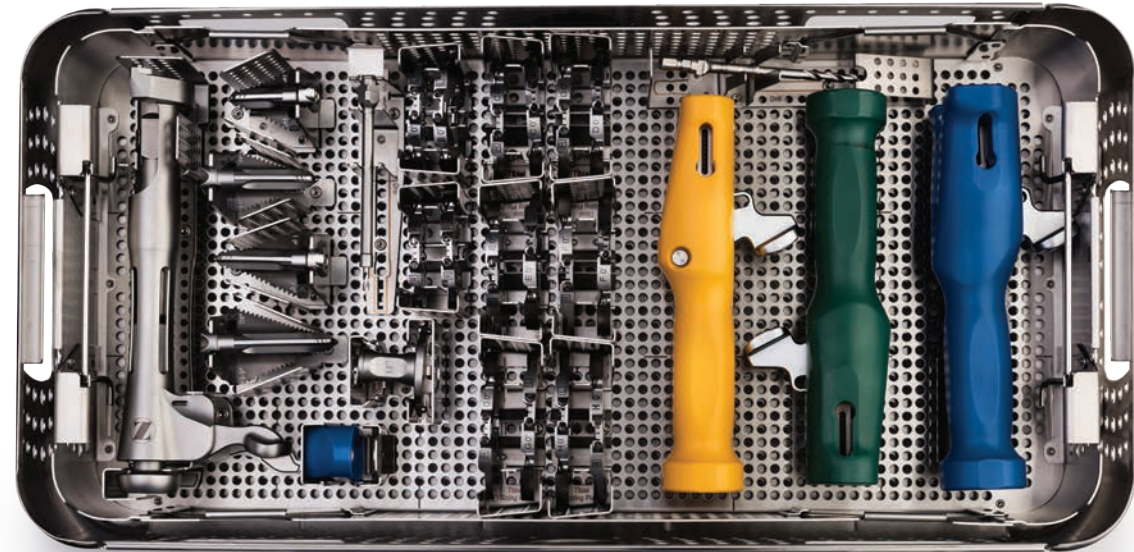

EFFICIENT INSTRUMENTATION KIT

The Persona Instrument System was designed with modular kitting, patient specific, and other instrument options that provide a greatly reduced instrument footprint without compromising the surgical technique, functionality, or procedural outcome. Persona Instrumentation is designed to offer an efficient, personalized approach to modern TKA.

- ✓ Reduced surgical steps*
- ✓ Reduced instrument trays*
- ✓ Increased instrument versatility*
- ✓ Increased ease of assembly with quick connect features, eliminating need for threaded components*
- ✓ Seamless intra-operative transitions

The OsseoTi Keel Tibia and Cemented Keel Tibia features a singular new instrument tray to incorporate into the existing line of Persona family instrument trays. In this one tray, the surgeon will have the ability to **seamlessly switch** between either the **cementless or cemented** procedure up to the point of implantation, providing versatility and options within the O.R.

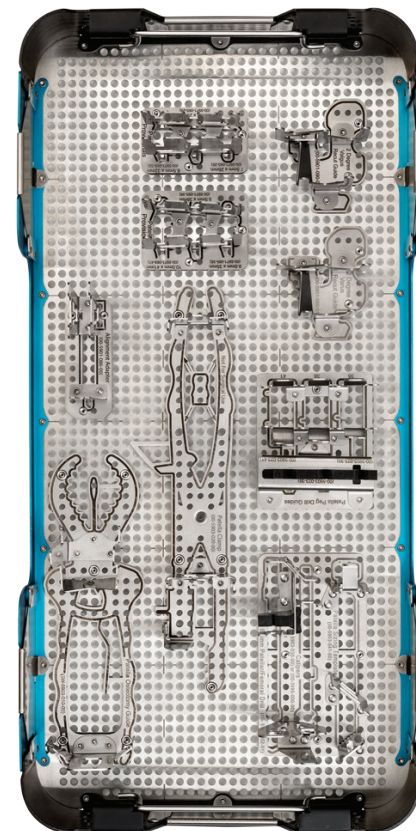

*compared to previous implant systems



VIVACIT-E® VITAMIN E ADVANCED BEARING TECHNOLOGY

Meeting the long-term performance⁴³ needs of patients

The Persona System also gives you the ability to address the needs of your most demanding patients with proven, proprietary technologies. The Vivacit-E Vitamin E Advanced Bearing Technology provides:

Benefits:

Exceptional oxidative stability⁴⁴⁻⁴⁸

Improved strength⁴⁹⁻⁵¹

Ultra-low wear⁵²

Vivacit-E Vitamin E Advanced Bearing Technology is grafted (locked) directly to the polyethylene chain to prevent elution for long-term oxidative protection.

Builds on the legacy of Longevity® Highly Crosslinked Polyethylene with more than 13 years of clinical success.⁴³

Oxidation or Significant Decline in Mechanical in Vivacit-E

0 SIGNS

When subjected to accelerated aging for 33 weeks⁵²

A Lifetime of Wear Resistance In Vivacit-E

95%

Wear Reduction Over Conventional Polyethylene at 100 Million Cycles⁵³

Precise Instrumentation with Personalized Control

Comprehensive Instrument Platform

Persona Instrumentation was designed to be versatile in its capabilities and philosophies, precise in its measurements, comprehensive, and comfortable with repetitive use. These options were designed to help you regularly achieve optimal outcomes.

- Intuitively designed instruments
- Designed to make knee replacement intuitive, precise, and simple.
- Intraoperative Flexibility

Precision and reproducibility engineered to simplify the surgical procedure

The Persona tibial resection workflow provides precision for proximal tibial resection. The instrument is easy to read and adjust, and its contour design fits to the bone for stability, designed to enable highly reproducible and accurate cuts.

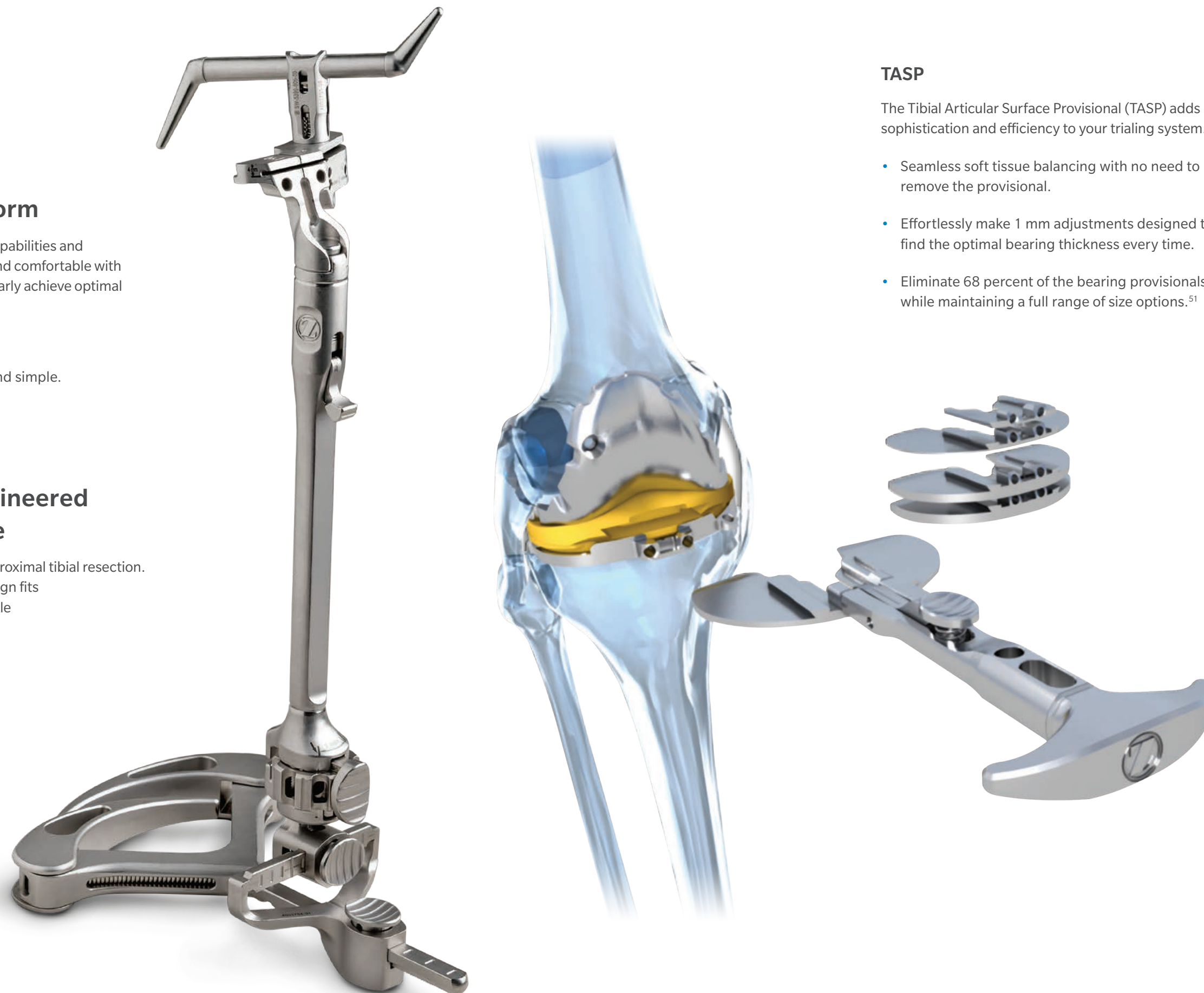

TASP

The Tibial Articular Surface Provisional (TASP) adds sophistication and efficiency to your trialing system.

- Seamless soft tissue balancing with no need to remove the provisional.
- Effortlessly make 1 mm adjustments designed to find the optimal bearing thickness every time.
- Eliminate 68 percent of the bearing provisionals while maintaining a full range of size options.⁵¹

References

- Kremers, Hilal Maradit, *et al.* "Prevalence of total hip and knee replacement in the United States." *The Journal of bone and joint surgery*. American volume 97.17 (2015): 1386.
- Bourne, R., *et al.* Patient Satisfaction After Total Knee Arthroplasty: Who Is Satisfied and Who Is Not? *Clinical Orthopaedics and Related Research*. 468: 57–63; 2010.
- Baker, P., *et al.* The Role of Pain and Function in Determining Patient Satisfaction After Total Knee Replacement. *National Registry for England and Wales in Journal of Bone and Joint Surgery (British)*. 89-B: 893–900; 2007.
- Pre-Surgical & Post-Surgical Patient Insights & Needs PPTX. Market Strategies International. March 30, 2009.
- Meneghini, R. and Russo G, Lieberman JR. Modern perceptions and expectations regarding total knee arthroplasty. *Journal of Knee Surgery*. 27:93–97; 2014.
- Vincent P. Galea, Mina A. Botros, Rami Madanat, · Christian S. Nielsen Charles Bragdon 2018 European Society of Sports Traumatology, Knee Surgery, Arthroscopy (ESSKA) 2018
- Dai, Y., *et al.* Anatomical Tibial Component Design Can Increase Tibial Coverage and Rotational Alignment Accuracy: A Comparison of Six Contemporary Designs. *Knee Surg Sports Traumatol Arthrosc*. 22:2911–2923; KSSSTA 2014
- Dai, Y., *et al.* Increased Shape and Size Offerings of Femoral Components Improve Fit During Total Knee Arthroplasty. *Knee Surg Sports Traumatol Arthrosc*. 22:2931–2940; KSSSTA 2014.
- Mahoney, O. and Kinsey, T. Overhang of the Femoral Component in Total Knee Arthroplasty: Risk Factors and Clinical Consequences. *Journal of Bone and Joint Surgery AM*. 92:1115-1121; 2010. doi:10.2106/JBJS.H.00434.
- Bizzozero, Paul *et al.* Morphologic Persona tibial implant decreases overhang rate - JoA 2018 2804-2809.
- Martin, S., *et al.* Maximizing Tibial Coverage Is Detrimental to Proper Rotational Alignment, CORR January 2014.
- Bandi, M., *et al.* Assessing the Effect of Finer Increments of Tibial Inlay Thickness on Laxity and Kinematics in Total Knee Arthroplasty – An Experimental and Numerical Investigation. Abstract number 962; ORS 2013.
- Nicoll, D. and Rowley, D. Internal rotational error of the tibial component is a major cause of pain after total knee replacement. *Journal of Bone and Joint Surgery (British)* 92- B:1238-44; 2010.
- Barrack, R., *et al.* Component Rotation and Anterior Knee Pain After Total Knee Arthroplasty. *Clinical Orthopaedics and Related Research*. Number 392, pages 46–55.
- Matsuda, S., *et al.* Effect of femoral and tibial component position on patellar tracking following total knee arthroplasty. *American Journal of Knee Surgery*. 14:152-156; 2001.
- Bedard, M., *et al.* Internal rotation of the tibial component is frequent in stiff total knee arthroplasty. *Clinical Orthopaedics and Related Research*, Vol. 469, no. 8, pages 2346–2355; 2011.
- Jeffrey Bischoff, *et al.* Kwong MD3 Patient Factors that Challenge Tibial Fixation in Cementless TKA are Not What They Seem; 1 AAOS Poster #83, 2019
- ZRR_WA_2409_11_Extended Aging of VE_2011
- Indelli, P., *et al.* Relationship between Tibial Baseplate Design and Rotational Alignment Landmarks in Primary Total Knee Arthroplasty. *Hindawi Publishing Corporation Arthritis*. Volume 2015, Article ID 189294, 8 pages. <http://dx.doi.org/10.1155/2015/189294>.
- Jin, C., *et al.* How Much Does the Anatomical Tibial Component Improve the Bony Coverage in Total Knee Arthroplasty? *The Journal of Arthroplasty*. In Press 2017. Online <http://dx.doi.org/10.1016/j.arth.2016.12.041>.
- Mizu-uchi, H., *et al.* Anatomical Shaped Tibial Baseplate Reduced Rotational Alignment Compromise in Total Knee Arthroplasty: Clinical Evaluation with Asian Knees. ORS 2017 Annual Meeting Paper No.0110.
- Hofmann, Aaron A., *et al.* "Ten-to 14-year clinical followup of the cementless Natural Knee system." *Clinical Orthopaedics and Related Research*® 388 (2001): 85-94.
- Hofmann, Aaron A., Scott M. Heithoff, and Marcelo Camargo. "Cementless total knee arthroplasty in patients 50 years or younger." *Clinical Orthopaedics and Related Research* (1976-2007) 404 (2002): 102-107.
- Lawrie, C. M., *et al.* "The cost of implanting a cemented versus cementless total knee arthroplasty." *The bone & joint journal* 101.7_Supple_C (2019): 61-63.
- Long M, Rack HJ. Titanium alloys in total joint replacement – A materials science perspective. (1998) *Biomaterials* 19:1621-1639
- Woodell-May J, Kumar M. In vitro comparison of cell proliferation on Ti6A14V and Tantalum Metal. ORS2007. Poster # 1578.
- Gupta, G. Evaluation of Bony Ingrowth Implant Materials in an In Vivo Sheep Long Bone Defect Model 12-04/12-07, February 2013.
- Karageorgiou, V. and Kaplan, D. "Porosity of 3D Biomaterial Scaffolds and Osteogenesis." *Biomaterials*, 26 (27): 5474-91, September 2005
- Hozack, W. *et al.* Primary Cementless Hip Arthroplasty with a Titanium Plasma Sprayed Prosthesis. *Clinical Orthopaedics and Related Research*. 333: 217-25, 1996.
- Head, W. *et al.* A Titanium Cementless Calcar Replacement Prosthesis in Revision Surgery of the Femur: 13 Year Experience. *Journal of Arthroplasty*. 16(8): 183-7, 2001.
- Head, W. *et al.* The Proximal Porous Coating Alternative for Primary Arthroplasty. *Orthopedics*. 22(9): 813-5, 1999.
- Keisu, K. *et al.* Primary Cementless Total Hip Arthroplasty in Octogenarians: Two to Eleven Year Follow-up. *Journal of Bone and Joint Surgery*. 83: 359, 2001.
- McLaughlin, J. *et al.* Total Hip Arthroplasty in Young Patients. 8 to 13 Year Results Using an Uncemented Stem. *Clinical Orthopaedics and Related Research*. 373: 152-63, 2000.
- Parvizi, J. *et al.* Prospective Matched-Pair Analysis of Hydroxyapatite-Coated and Uncoated Femoral Stems in Total Hip Arthroplasty. *Journal of Bone and Joint Surgery*. 83: 783-6, 2004.
- McLaughlin, J. *et al.* Total Hip Arthroplasty with an Uncemented Femoral Component. A Long Term study of the Taperloc Stem. *Journal of Arthroplasty*. 19(2): 151-6, 2004.
- Meding, K. *et al.* Minimum Ten-Year Follow-up of a Straight-Stemmed, Plasma-Sprayed, Titanium-Alloy, Uncemented Femoral Component in Primary Total Hip Arthroplasty. *Journal of Bone and Joint Surgery*. 86: 92-7, 2004
- McLaughlin, J.R., *et al.* Long-term results of uncemented total hip arthroplasty with the Taperloc femoral component in patients with Dorr type C proximal femoral morphology. *The Bone & Joint Journal* 2016; 98-B:595-600
- Bourne, Robert B. *et al.* Ingrowth Surfaces: Plasma Spray Coating to Titanium Alloy Hip Replacements. *Clinical Orthopaedics and Related Research*. 1994; 298: 37-46.
- Persona Knee System IFU/package insert.
- Z10011A Project History File on file at Zimmer Biomet
- Tsubosaka, M., Ishida, K., Kodato, K., Shibamura, N., Hayashi, S., Kurosaka, M., Kuroda, R. and Matsumoto, T., 2020. Mid-flexion stability in the anteroposterior plane is achieved with a medial congruent insert in cruciate-retaining total knee arthroplasty for varus osteoarthritis. *Knee Surgery, Sports Traumatology, Arthroscopy*, 29(2), pp.467-473
- Frye, B., Patton, C., Kinney, J., Murphy, T., Klein, A. and Dietz, M., 2021. A Medial Congruent Polyethylene Offers Satisfactory Early Outcomes and Patient Satisfaction in Total Knee Arthroplasty. *Arthroplasty Today*, 7, pp.243-249.e0.
- Bragdon, C. *et al.* Clinical Multicenter Studies of the Wear Performance of Highly Crosslinked Remelted Polyethylene in THA. *Clin Orthop Relat Res* (2013) 471:393-402.
- Oral, E. *et al.* Crosslinked Vitamin E Blended UHMWPE with Improved Grafting and Wear Resistance. Poster No. 1181. ORS 2011 Meeting.
- Oral, E. *et al.* Trace amounts of grafted vitamin E protect UHMWPE against squalene-initiated oxidation. Poster No. 1295. ORS 2011 Meeting
- Rowell, S. *et al.* Detection of Vitamin E in Irradiated UHMWPE by UV-Visible Spectroscopy. Poster No. 1186. ORS 2011 Meeting.
- Wolf, C. *et al.* Radiation Grafting of Vitamin E to Ultra High Molecular Weight Polyethylene. Poster No. 1178. ORS 2011 Meeting.
- Pletcher, D. *et al.* Vitamin E Grafted HXPE Shows Superior Mechanical Property Retention Compared to Conventional UHMWPE and Sequentially Annealed HXP. Poster No. 1868, ORS 2014 Meeting.
- Zimmer ZRR_WA_2401_11, Rev. 2.
- Zimmer TM1140.98
- Zimmer ZRR_WA_2512_12
- Mimnaugh, K. *et al.* 100 Million-Cycle Wear Evaluation of Crosslinked Vitamin E Grafted Polyethylene (VE-HXPE) Acetabular Liners. Paper No. 0403. ORS 2016 Annual Meeting.
- Data based on calculation of total trials in instrument trial system compared to the trials needed with the TASP system.

All content herein is protected by copyright, trademarks and other intellectual property rights, as applicable, owned by or licensed to Zimmer Biomet or its affiliates unless otherwise indicated, and must not be redistributed, duplicated or disclosed, in whole or in part, without the express written consent of Zimmer Biomet.

This material is intended for health care professionals. Distribution to any other recipient is prohibited.

For product information, including indications, contraindications, warnings, precautions, potential adverse effects and patient counseling information, see the package insert and www.zimmerbiomet.com.

Check for country product clearances and reference product specific instructions for use. Not for distribution in France

©2023 Zimmer Biomet



Legal Manufacturer
Zimmer, Inc.
1800 West Center Street
Warsaw, Indiana 46580
USA